

# JMA-3400Series

---

**MARINE RADAR  
EQUIPMENT**

**INSTRUCTION  
MANUAL**



# PRECAUTIONS BEFORE OPERATION

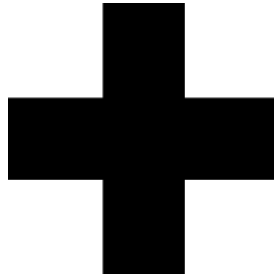

## Cautions for High Voltage

High voltages, ranging from several hundreds to tens of thousands of volts, are used in electronic apparatus, such as radio and radar instruments. These voltages are totally harmless in most operations. However, touching a component inside the unit is very dangerous. (Any person other than authorized service engineers should not maintain, inspect, or adjust the unit.)

High voltages on the order of tens of thousand volts are most likely to cause instant deaths from electrical shocks. At times, even voltages on the order of several hundred volts could lead to electrocution. To defend against electrical shock hazards, don't put your hand into the inside of apparatus. When you put in a hand unavoidably in case of urgent, it is strongly suggested to turn off the power switch and allow the capacitors, etc. to discharge with a wire having its one end positively grounded to remove residual charges. Before you put your hand into the inside of apparatus, make sure that internal parts are no longer charged. Extra protection is ensured by wearing dry cotton gloves at this time. Another important precaution to observe is to keep one hand in your pocket at a time, instead of using both hands at the same time.

It is also important to select a secure footing to work on, as the secondary effects of electrical shock hazards can be more serious. In the event of electrical shocks, disinfect the burnt site completely and obtain medical care immediately.

## Precautions for Rescue of Victim of Electric Shock

When a victim of electric shock is found, turn off the power source and ground the circuit immediately. If this is impossible, move the victim away from the unit as quick as possible without touching him or her with bare hands. He or she can safely be moved if an insulating material such as dry wood plate or cloth is used.

Breathing may stop if current flows through the respiration center of brain due to electric shock. If the electric shock is not large, breathing can be restored by artificial respiration. A victim of electric shock looks pale and his or her pulse may become very weak or stop, resulting in unconsciousness and rigidity at worst. It is necessary to perform first aid immediately.

# FIRST-AID TREATMENTS

## Method of First-Aid Treatment

### ☆ Precautions for First-Aid Treatments

Apply artificial respiration to the person who collapsed, minimizing moving as much as possible avoiding risks. Once started, artificial respiration should be continued rhythmically.

- (1) Refrain from touching the patient carelessly as a result of the accident; the first-aiders could suffer from electrical shocks by himself or herself.
- (2) Turn off the power calmly and certainly, and move the patient apart from the cable gently.
- (3) Call or send for a physician or ambulance immediately, or ask someone to call doctor.
- (4) Lay the patient on the back, loosening the necktie, clothes, belts and so on.
- (5)
  - (a) Feel the patient's pulse.
  - (b) Check the heartbeat by bringing your ear close to the patient's heart.
  - (c) Check for respiration by bringing your face or the back of your hand to the patient's face.
  - (d) Check the size of patient's pupils.
- (6) Opening the patient's mouth, remove artificial teeth, cigarettes, chewing gum, etc. if any. With the patient's mouth open, stretch the tongue and insert a towel or the like into the mouth to prevent the tongue from being withdrawn into the throat. (If the patient clenches the teeth so tight that the mouth won't open, use a screwdriver or the like to force the mouth open and then insert a towel or the like into the mouth.)
- (7) Wipe off the mouth to prevent foaming mucus and saliva from accumulating.

## ★ Treatment to Give When the Patient Has a Pulse Beating but Has Ceased to Breathe

\* Performing mouth-to-mouth artificial respiration - Fig. 1

- (1) Bend the patient's face backward until it is directed to look back. (A pillow may be placed under the neck.)
- (2) Pull up the lower jaw to open up the airway. (To spread the airway)
- (3) Pinching the patient's nose, breathe deeply and blow your breath into the patient's mouth strongly, with care to close it completely. Then, move your mouth away and take a deep breath, and blow into his or her mouth. Give rescue breathing twice in about 1 second and check if the chest rises. (always with the patient's nostrils closed).
- (4) Immediately, perform chest compressions.(perform uninterrupted chest compressions of 30 at the rate of about 100 times per minute. With each compression, depress the chest wall to a depth of approximately 4 to 5 cm.) Rapidly, give 2 rescue breaths. Continuously perform the combination of 30 chest compressions and 2 rescue breaths without interruption. (Perform the cardiac massage and mouth-to-mouth respiration)
- (5) Continue the cardiac massage and mouth-to-mouth respiration until natural respiration is restored.
- (6) If the patient's mouth won't open easily, insert a pipe, such as one made of rubber or vinyl, into either nostril. Then, take a deep breath and blow into the nostril through the pipe, with the other nostril and the mouth completely closed.
- (7) The patient may stand up abruptly upon recovering consciousness. Keep the patient lying calmly, giving him or her coffee, tea or any other hot drink (but not alcoholic drink) to keep him or her warm.

Mouth-to-mouth artificial respiration with the patient's head lifted

- |     |   |  |
|-----|---|--|
| [1] |  | <p>(1) Lift the back part of the patient's head. Support the forehead with one of your hand and the neck with the other hand.→[1].<br/>Many patients will have their airways opened by lifting their head in this way to ease mouth-to-mouth artificial respiration.</p> |
| [2] |  | <p>(2) Closing the patient's mouth with your mouth, press your cheek against the patient's nose→ [2].<br/>Alternatively, hold the patient's nose with your finger to prevent air leak → [3].</p>   |
| [3] |  | <p>(3) Blowing air into the patient's lungs. Blow air into the patient's lungs until chest is seen to rise. (always with the patient's nostrils closed) Give rescue breathing twice in about 1 second and check if the chest rises.</p>                                  |

Fig. 1 Mouth-to-mouth artificial respiration

## ★ Treatment to Give When the Patient Has No Pulse Beating and Has Ceased to Breathe

### \* Performing cardiac massage - Fig. 2

If the patient has no pulse beating, with the pupils open and no heartbeat being heard, the patient has a cardiac arrest and requires immediate artificial respiration. Continue this until a medical specialist arrives, and follow his or her directions after that.

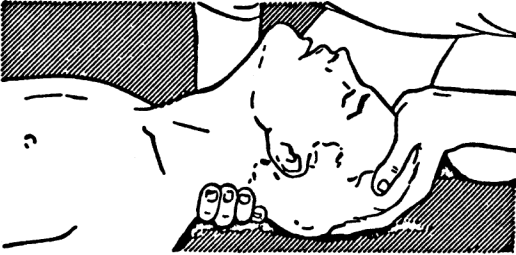
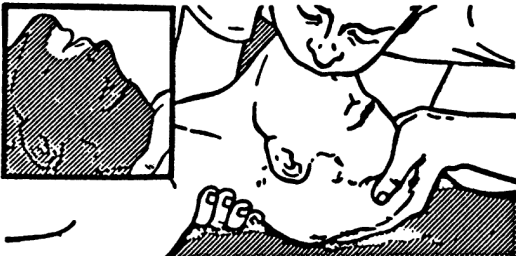
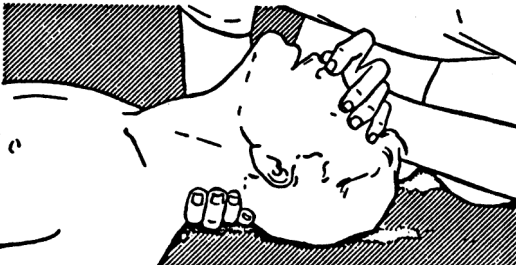
- (1) Putting one hand on about the lower one third of the patient's ribs and the other hand over the back of the first, with your elbow fully stretched (with bended elbow, you can't press to the extent the patient's ribs are depressed), apply your body weight to the hands to press the patient's body until it is depress the chest wall to a depth of approximately 4 to 5 cm. (Chest compressions of 30 at the rate of about 100 times per minute.). (Cardiac massage)
- (2) If only one first-aider is available, perform a cardiac massage about 30 times and then give mouth-to-mouth artificial respiration 2 times. Repeat this sequence.  
If two first-aiders are available, while one person performs a cardiac massage 30 times, the other should give mouth-to-mouth artificial respiration 2 times. Repeat this sequence. (Combined cardiac massage and mouth-to-mouth artificial respiration method)
- (3) Check the patient's pupils and feel the pulse from time to time. When the pupils are restored to normal and the pulse begins to beat regularly, stop treating and keep the patient calm while giving him or her coffee, tea or any other hot drink to keep him or her warm while watching him or her carefully.

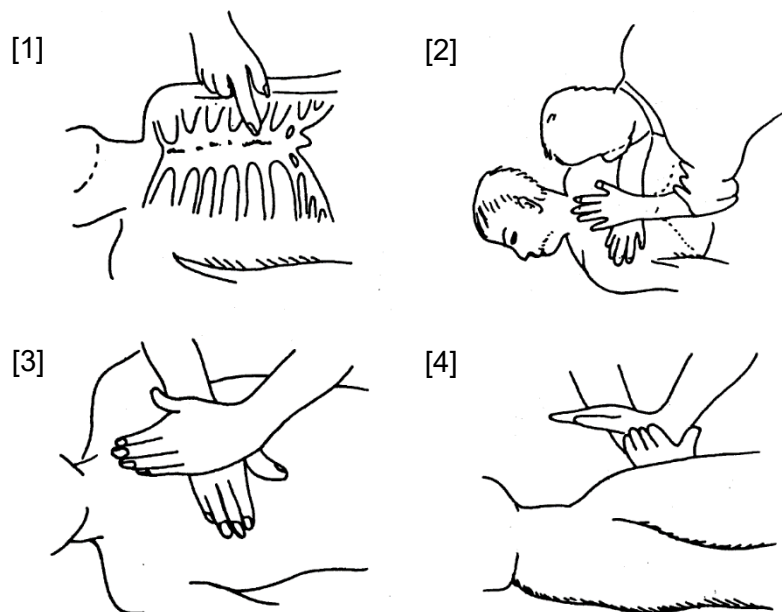
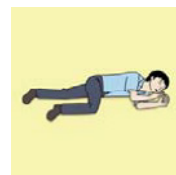
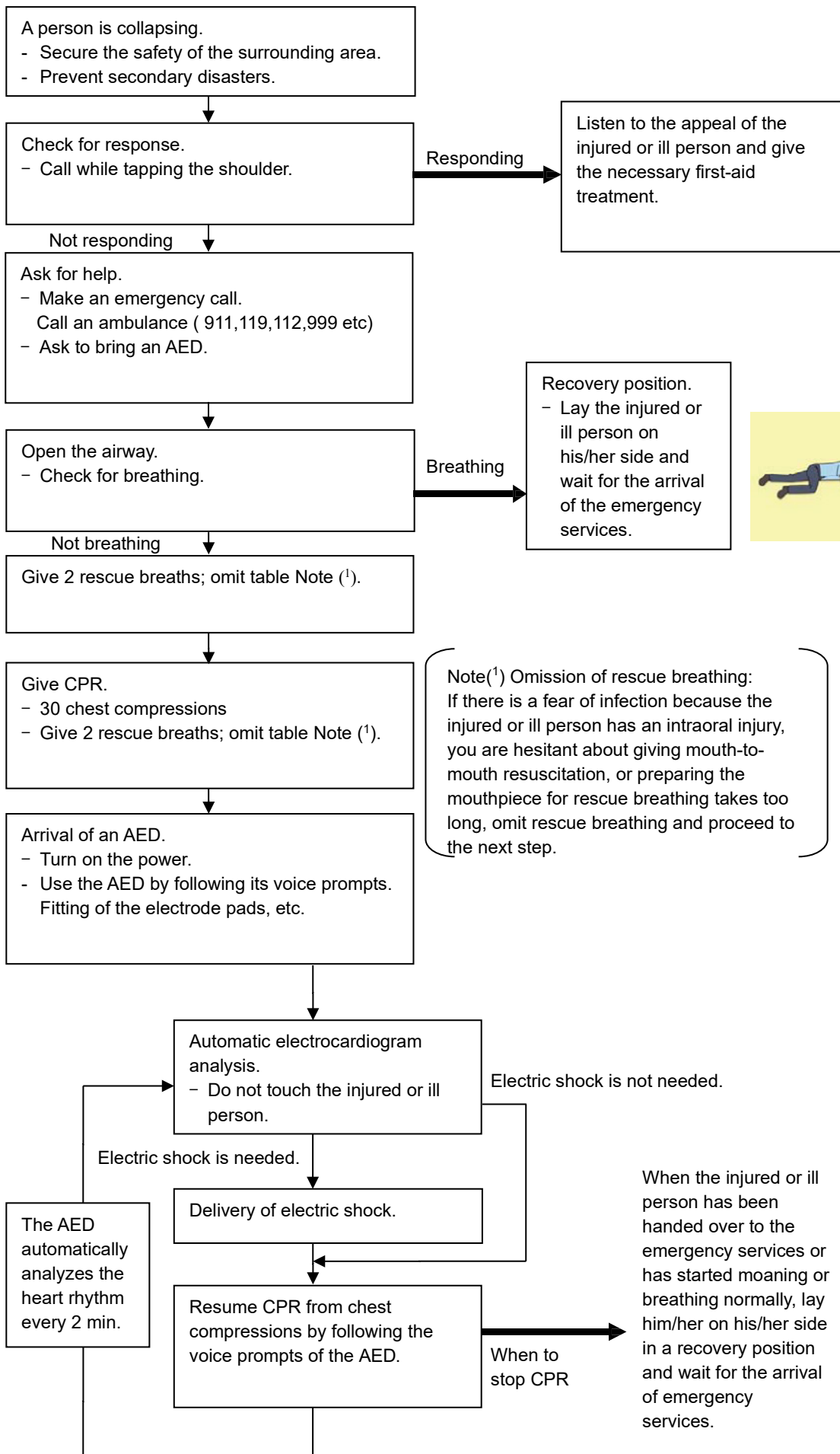

Fig. 2 Cardiac massage

### Procedure for Cardiopulmonary Resuscitation (CPR) Using the AED

### (Automated External Defibrillator)



## Procedure for Cardiopulmonary Resuscitation (CPR) Using the AED (Automated External Defibrillator)

### 1. Check the scene for safety to prevent secondary disasters

- a) Do not touch the injured or ill person in panic when an accident has occurred. (Doing so may cause electric shock to the first-aiders.)
- b) Do not panic and be sure to turn off the power. Then, gently move the injured or ill person to a safe place away from the electrical circuit.



### 2. Check for responsiveness

- a) Tap the shoulder of the injured or ill and shout in the ear saying, "Are you OK?"
- b) If the person opens his/her eyes or there is some response or gesture, determine it as "responding." But, if there is no response or gesture, determine it as "not responding."

### 3. If responding

- a) Give first-aid treatment.

### 4. If not responding

- a) Ask for help loudly. Ask somebody to make an emergency call and bring an AED.
  - Somebody has collapsed. Please help.
  - Please **call an ambulance**. (Call 911,119,112,999 etc. by local number)
  - Please bring an **AED**.
  - If there is nobody to help, call an ambulance by yourself.



### 5. Open the airway

- a) Touch the forehead with one hand. Lift the chin with the two fingers of the middle finger and forefinger of the other hand and push down on the forehead as you lift the jaw to bring the chin forward to open the airway. If neck injury is suspected, open the airway by lifting the lower jaw.

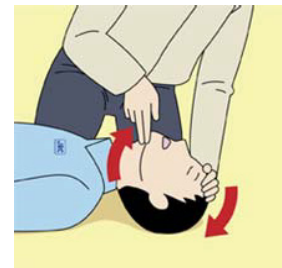

### 6. Check for breathing

- a) After opening the airway, check quickly for breathing for no more than 10 seconds. Put your cheek down by the mouth and nose area of the injured or ill person, look at his/her chest and abdomen, and check the following three points.
  - Look to see if the chest and abdomen are rising and falling.
  - Listen for breathing.
  - Feel for breath against your cheek.



- b) If the injured or ill person is breathing, place him/her in the recovery position and wait for the arrival of the emergency services.
  - Position the injured or ill person on his/her side, maintain a clear and open airway by pushing the head backward while positioning their mouth downward. To maintain proper blood circulation, roll him/her gently to position them in the recovery position in the opposite direction every 30 minutes.





**7. Give 2 rescue breaths (omittable)**

- a) If opening the airway does not cause the injured or ill person to begin to breathe normally, give rescue breaths.
- b) If there is a fear of infection because the injured or ill person has an intraoral injury, you are hesitant about giving mouth-to-mouth resuscitation, or getting and preparing the mouthpiece for rescue breathing takes too long, omit rescue breathing and perform chest compressions.
- c) When performing rescue breathing, it is recommended to use a mouthpiece for rescue breathing and other protective devices to prevent infections.
- d) While maintaining an open airway, pinch the person's nose shut with your thumb and forefinger of the hand used to push down the forehead.
- e) Open your mouth widely to completely cover the mouth of the injured or ill person so that no air will escape. Give rescue breathing twice in about 1 second and check if the chest rises.

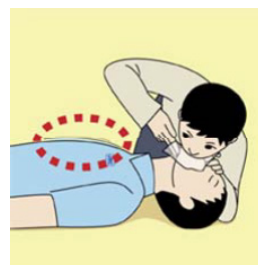

**8. Cardiopulmonary resuscitation (CPR) (combination of chest compressions and rescue breaths)**

a) Chest compressions

1) Position of chest compressions

- Position the heel of one hand in the center of the chest, approximately between the nipples, and place your other hand on top of the one that is in position.

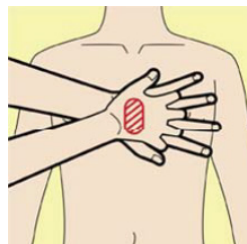
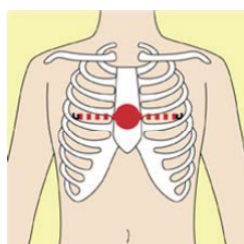

2) Perform chest compressions

- Perform uninterrupted chest compressions of 30 at the rate of about 100 times per minute.
- While locking your elbows positioning yourself vertically above your hands.
- With each compression, depress the chest wall to a depth of approximately 4 to 5 cm.

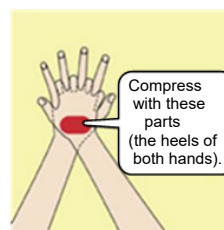

b) Combination of 30 chest compressions and 2 rescue breaths

- 1) After performing 30 chest compressions, give 2 rescue breaths. If rescue breathing is omitted, perform only chest compressions.
- 2) Continuously perform the combination of 30 chest compressions and 2 rescue breaths without interruption.
- 3) If there are two or more first-aiders, alternate with each other approximately every two minutes (five cycles of compressions and ventilations at a ratio of 30:2) without interruption.

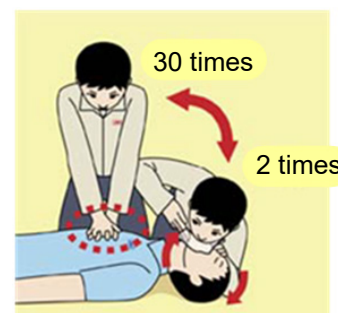

**9. When to stop cardiopulmonary resuscitation (CPR)**

- a) When the injured or ill person has been handed over to the emergency services
- b) When the injured or ill person has started moaning or breathing normally, lay him/her on his/her side in a recovery position and wait for the arrival of emergency services.

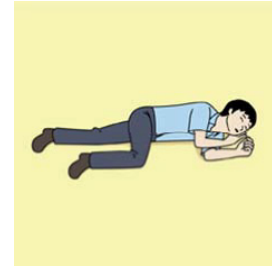

**10. Arrival and preparation of an AED**

- a) Place the AED at an easy-to-use position. If there are multiple first-aiders, continue CPR until the AED becomes ready.
- b) Turn on the power to the AED unit. Depending on the model of the AED, you may have to push the power on button, or the AED automatically turns on when you open the cover.
- c) Follow the voice prompts of the AED.

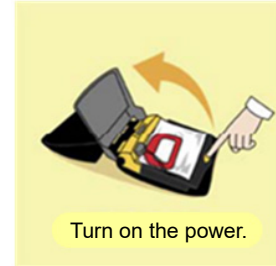
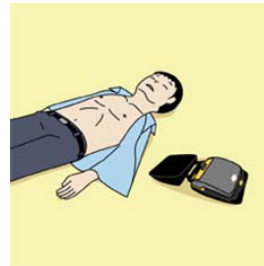

**11. Attach the electrode pads to the injured or ill person's bare chest**

- a) Remove all clothing from the chest, abdomen, and arms (male or female).
- b) Open the package of electrode pads, peel the pads off and securely place them on the chest of the injured or ill person, with the adhesive side facing the chest. If the pads are not securely attached to the chest, the AED may not function. Paste the pads exactly at the positions indicated on the pads. If the chest is wet with water, wipe dry with a dry towel and the like, and then paste the pads. If there is a pacemaker or implantable cardioverter defibrillator (ICD), paste the pads at least 3cm away from them. If a medical patch or plaster is present, peel it off and then paste the pads. If the injured or ill person's chest hair is thick, paste the pads on the chest hair once, peel them off to remove the chest hair, and then paste new pads.
- c) Some AED models require to connect a connector by following voice prompts.
- d) Do not put child pads on adults (older than 8 years).

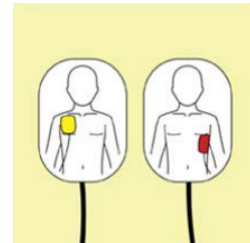

**12. Electrocardiogram analysis**

- a) The AED automatically analyzes electrocardiograms. Follow the voice prompts of the AED and ensure that nobody is touching the injured or ill person while you are operating the AED.
- b) On some AED models, you may need to push a button to analyze the heart rhythm.

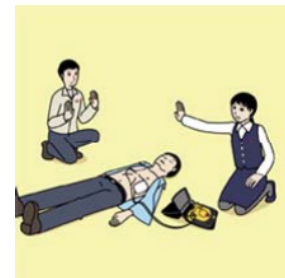

**13. Electric shock (defibrillation)**

- a) If the AED determines that electric shock is needed, the voice prompt saying, "Shock is needed" is issued and charging starts automatically.
- b) When charging is completed, the voice prompt saying, "Push the shock button" is issued and the shock button flashes.
- c) The first-aiders must get away from the injured or ill person, make sure that no one is touching him/her, and then press the shock button.
- d) When electric shock is delivered, the body of the injured or ill person may jerk.



**14. Resume cardiopulmonary resuscitation (CPR)**

Resume CPR consisting of 30 chest compressions and 2 rescue breaths by following the voice prompts of the AED.

**15. Automatic electrocardiogram analysis**

- a) When 2 minutes have elapsed since you resumed cardiopulmonary resuscitation (CPR), the AED automatically analyzes the electrocardiogram.
- b) If you suspended CPR by following voice prompts and AED voice prompt informs you that shock is needed, give electric shock again by following the voice prompts.  
If AED voice prompt informs you that no shock is needed, immediately resume CPR.

**16. When to stop CPR (Keep the electrode pads on)**

- a) When the injured or ill person has been handed over to the emergency services
- b) When the injured or ill person has started moaning or breathing normally, lay him/her on his/her side in a recovery position and wait for the arrival of emergency services.

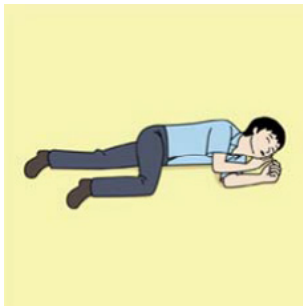

# PREFACE

Thank you very much for purchasing the JRC marine radar equipment, JMA-3400 series. This equipment is a marine radar equipment designed to obtain safe operation of marine ships. This equipment consists of a scanner unit and a display unit as its main units.

- Before operating the equipment, be sure to read this instruction manual carefully for correct operation.
- Maintain this instruction manual so that operators can refer to it at anytime. Refer to this manual when any inconvenience or defect occurs.

## About equipment type names:

JMA-3400 is a radar series model name.

Individual name is changed according with the combination of units.

### JMA-3400 Series

JMA-3404	⇒	Display Unit NCD-2364 + Scanner Unit NKE-2043
JMA-3406	⇒	Display Unit NCD-2364 + Scanner Unit NKE-2063A/AHS
JMA-3411-4	⇒	Display Unit NCD-2364 + Scanner Unit NKE-2103-4/4HS
JMA-3411-6	⇒	Display Unit NCD-2364 + Scanner Unit NKE-2103-6/6HS

# CHECKING THE SUPPLIED ITEMS

## STANDARD SUPPLY ITEMS

Standard supply items are as follows.

Optional special length cables are prepared by JRC if request.

Option cable is provided with a length of 5m, 10m, 15m, 20m, or 30m. (Please order it if necessary)

**SCANNER UNIT**      1 set /    **DISPLAY UNIT**    1 set  
**POWER CABLE (DC input cable 3m)**    1 Piece  
**INSTRUCTION MANUAL**      1 Piece (This book)

### NOTE:

This radar display is possible to use AIS, TT, LL\_ position, Depth, and N-UP functions. But those all functions need the signal input from GPS, AIS, GYRO, LOG, ECHO SOUNDERS. ALL external signals are connected using NMEA cable. This cable is sold separately as an optional accessory, it is not included in the standard supply items.

## OPTION UNITS (Not included in standard supplied items)

Please order to JRC agent or factory if necessary.



- ★ **SCANNER to DISPLAY Cable: 5m, 10m, 15m, 20m, 30m**
- ★ **NMEA Signal connection cable: GPS, NMEA0183, CAN**
- ★ **Rubber cap for SCANNER to DISPLAY Cable**

# BEFORE OPERATION

## PICTORIAL INDICATION

Various pictorial indications are included in this manual and are shown on these equipment so that you can operate them safely and correctly and prevent any danger to you and/or to other persons and any damage to your property during operation. Such indications and their meanings are as follows.

Understand them before you read this manual.

	<b>DANGER</b>	This indication is shown where incorrect equipment operation due to negligence may cause death or serious injuries.
	<b>WARNING</b>	This indication is shown where any person is supposed to be in danger of being killed or seriously injured if this indication is neglected and these equipment are not operated correctly.
	<b>CAUTION</b>	This indication is shown where any person is supposed to be injured or any property damage is supposed to occur if this indication is neglected and these equipment are not operated correctly.

## EXAMPLES OF PICTORIAL INDICATION



Electric Shock

The  $\triangle$  mark represents CAUTION (including DANGER and WARNING).

Detailed contents of CAUTION ("Electric Shock" in the example on the left) is shown in the mark.



Disassembling Prohibited



Prohibited

The  $\otimes$  mark represents prohibition.

Detailed contents of the prohibited action ("Disassembling Prohibited" in the example on the left) is shown in the mark.



Disconnect the power plug



Instruction

The  $\bullet$  mark represents instruction.

Detailed contents of the instruction ("Disconnect the power plug" in the example on the left) is shown in the mark.

## RUSSIA CTP MARK

According to the requirements of clause 20 of Technical Regulations about safety of Maritime transport objects, approved by Resolution of the Russian Federation Government #620 dated August 12, 2010 and requirements Technical Regulation of the Russian Federation Government #623 dated August 12, 2010 navigation & radiotelephone equipment should be marked by company – manufacturer with market-circulation mark the way it is determined by Legislation of the Russia federation on technical regulation.

According to the article 27 PZ No184 –FZ of Federal Law about Technical Regulation dated December 12, 2002 and Resolution of the Russian Federation Government dated 19.11.03 No0696 navigation equipment has an appropriate marking. The marking can be performed by one of four variants, depending on surface colour of equipment.

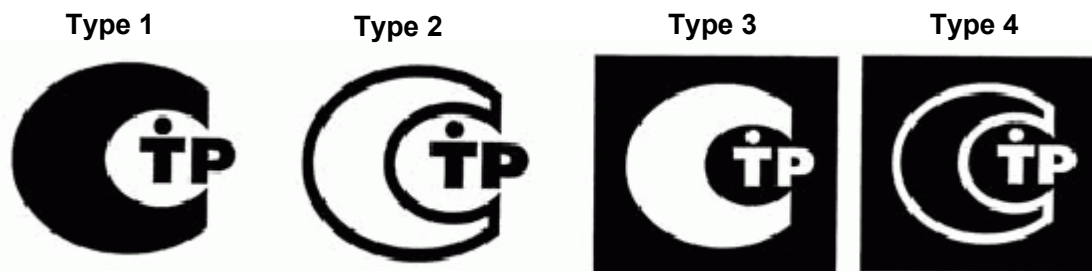

The images should be grey scale and should contrast against the surface colour (ref. to the Resolution of the Russian Federation Government No696 <<About market circulation mark>> dated November 19, 2003).

The marking of Radio and navigation equipment should be done by the manufacturer (supplier) according to the clause 2 of the article 27 of the Federal Law No.184 –FZ << About technical Regulation>> and should be applied right to device surface.

## WARNING STATEMENTS FOR INDUSTRY CANADA



# WARNING

**ENGLISH:**

This device complies with Industry Canada license-exempt RSS standard(s). Operation is subject to the following two conditions:

(1) this device may not cause interference, and (2) this device must accept any interference, including interference that may cause undesired operation of the device.

**FRANÇAIS:**

Le présent appareil est conforme aux CNR d'Industrie Canada applicables aux appareils radio exempts de licence. L'exploitation est autorisée aux deux conditions suivantes:

(1) l'appareil ne doit pas produire de brouillage, et (2) l'utilisateur de l'appareil doit accepter tout brouillage radioélectrique subi, même si le brouillage est susceptible d'en compromettre le fonctionnement.

**Microwave radiation level:**

Keep away from a scanner when it is transmitting.

The high level of microwave is radiated from the front face of the scanner specified below. The microwave exposure at close range could result in injuries (especially of the eyes).

Item under test	50W/m <sup>2</sup>	10W/m <sup>2</sup>	2.5W/m <sup>2</sup>
NKE-2043	NA	40cm	NA
NKE-2063A	NA	22cm	NA
NKE-2103-4	NA	26cm	123cm
NKE-2103-6	NA	26cm	123cm

**Information:**

<https://www.canada.ca/en/health-canada/services/publications/health-risks-safety/limits-human-exposure-radiofrequency-electromagnetic-energy-range-3-300.html#s2>

**FRANÇAIS:****Micro-ondes niveau de rayonnement:**

Tenir à l'écart à partir d'un scanner lorsqu'il transmet.

Le niveau élevé de micro-onde est rayonnée à partir de la face avant de l'analyseur décrit ci-dessous. L'exposition aux micro-ondes à courte portée peut entraîner des blessures (notamment des yeux).







Article en cours de test	50W/m <sup>2</sup>	10W/m <sup>2</sup>	2.5W/m <sup>2</sup>
NKE-2043	NA	40cm	NA
NKE-2063A	NA	22cm	NA
NKE-2103-4	NA	26cm	123cm
NKE-2103-6	NA	26cm	123cm

**Information:**







<https://www.canada.ca/en/health-canada/services/publications/health-risks-safety/limits-human-exposure-radiofrequency-electromagnetic-energy-range-3-300.html#s2>











# PRECAUTIONS

 <b>DANGER</b>	
	<p>Never carry out internal inspection or repair work of the equipment by users.</p> <p>Inspection or repair work by unauthorized personnel may result in fire hazard or electric shock.</p> <p>For inspection and repair work of equipment components, consult with our branch office, branch shop, sales office, or our distributor in your district.</p>
	<p>When conducting maintenance, make sure to turn the main power off.</p> <p>Failure to comply may result in electrocution.</p>
	<p>Turn off the main power before cleaning the equipment. Especially when a rectifier is used, make sure to turn it off since voltage is still output from the rectifier even after the radar is turned off.</p> <p>Failure to comply may result in equipment failure, electric shock or serious injury.</p>
	<p>Turn off the main power before maintaining the scanner unit.</p> <p>Failure to comply may result in electric shock or serious injury.</p>
	<p>When conducting maintenance work on the antenna, make sure to turn its main power off.</p> <p>Failure to comply may result in electrocution or injuries.</p>











# **WARNING**





	<p>Never directly touch the internal components of the antenna, receiver/transceiver, or indicator.</p> <p>Direct contact with these high voltage components may cause electrocution. For maintenance, inspection, or adjustment of equipment components, consult with our branch office, branch shop, sales office, or our distributor in your district.</p>																				
	<p>Do not get close to the radiant section of the radar antenna. It is a rotating part, and it may cause injuries if it suddenly starts rotating and consequently hits the body. The radiant section be installed at a high place such as on the roof of the wheelhouse, on the flying bridge, on the trestle, or on the radar mast so that no one can get close to it.</p>																				
	<p><b>Microwave radiation level:</b> Keep away from a scanner when it is transmitting. The high level of microwave is radiated from the front face of the scanner specified below. The microwave exposure at close range could result in injuries (especially of the eyes).</p> <table border="1" style="margin-left: auto; margin-right: auto; border-collapse: collapse; text-align: center;"> <thead> <tr> <th style="padding: 5px;">Item under test</th> <th style="padding: 5px;">50W/m<sup>2</sup></th> <th style="padding: 5px;">10W/m<sup>2</sup></th> <th style="padding: 5px;">2.5W/m<sup>2</sup></th> </tr> </thead> <tbody> <tr> <td style="padding: 5px;">NKE-2043</td> <td style="padding: 5px;">NA</td> <td style="padding: 5px;">40cm</td> <td style="padding: 5px;">NA</td> </tr> <tr> <td style="padding: 5px;">NKE-2063A</td> <td style="padding: 5px;">NA</td> <td style="padding: 5px;">22cm</td> <td style="padding: 5px;">NA</td> </tr> <tr> <td style="padding: 5px;">NKE-2103-4</td> <td style="padding: 5px;">NA</td> <td style="padding: 5px;">26cm</td> <td style="padding: 5px;">123cm</td> </tr> <tr> <td style="padding: 5px;">NKE-2103-6</td> <td style="padding: 5px;">NA</td> <td style="padding: 5px;">26cm</td> <td style="padding: 5px;">123cm</td> </tr> </tbody> </table>	Item under test	50W/m <sup>2</sup>	10W/m <sup>2</sup>	2.5W/m <sup>2</sup>	NKE-2043	NA	40cm	NA	NKE-2063A	NA	22cm	NA	NKE-2103-4	NA	26cm	123cm	NKE-2103-6	NA	26cm	123cm
Item under test	50W/m <sup>2</sup>	10W/m <sup>2</sup>	2.5W/m <sup>2</sup>																		
NKE-2043	NA	40cm	NA																		
NKE-2063A	NA	22cm	NA																		
NKE-2103-4	NA	26cm	123cm																		
NKE-2103-6	NA	26cm	123cm																		
	<p>Make sure to install the antenna at a place higher than human height. Direct exposure to electromagnetic waves at close range will have adverse effects on the human body.</p>																				
	<p>Direct exposure to electromagnetic waves at close range will have adverse effects on the human body. When it is necessary to get close to the antenna for maintenance or inspection purposes, make sure to turn the indicator power switch to "OFF" or "STBY."</p>																				
	<p>When conducting maintenance work, make sure to turn off the power and unplug the power connector J1 of the display unit so that the power supply to the equipment is completely cut off.</p> <p>Some equipment components can carry electrical current even after the power switch is turned off, and conducting maintenance work without unplugging the power connector may result in electrocution, equipment failure, or accidents.</p>																				
	<p>Take care, even if you did power off, the antenna may rotate by wind.</p>																				

# CAUTION

	Do not take apart, and do not remodel the display unit. This could cause water to seep inside the display unit.
	A malfunction may occur if the power in the ship is instantaneously interrupted during operation of the radar. In this case, the power should be turned on again.
	Always use the automatic tuning mode. Use the manual tuning mode only when the automatic tuning mode does not provide the best tuning state due to deterioration of magnetron for example.
	If sensitivity is set too high, unnecessary signals such as noises in the receiver and false echoes increase to lower target visibility. At the same time, if sensitivity is set too low, detection of targets such as ships and dangerous objects may be hindered. Therefore, sensitivity must always be set to an optimal level.
	When using the sea clutter suppression function, never set the suppression level too high canceling out all image noises from the sea surface at close range. Detection of not only echoes from waves but also targets such as other ships or dangerous objects will become inhibited. When using the sea clutter suppression function, make sure to choose the most appropriate image noise suppression level.
	When using the rain/snow reflection suppression function, never set the suppression level too high canceling out all image noises from the rain or snow. Detection of not only echoes from the rain or snow but also targets such as other ships or dangerous objects will become inhibited. When using the rain/snow reflection suppression function, make sure to choose the most appropriate image noise suppression level.
	Use the radar only as a navigation aid. The final navigation decision must always be made by the operator him/herself. Making the final navigation decision based only on the radar display may cause accidents such as collisions or running aground.
	Use the target tracking function (TT) only as a navigation aid. The final navigation decision must always be made by the operator him/herself. Making the final navigation decision based only on the target tracking function (TT) information may cause accidents. The target tracking function (TT) information such as vector, target numerical data, and alarms may contain some errors. Also, targets that are not detected by the radar cannot be acquired or tracked. Making the final navigation decision based only on the radar display may cause accidents such as collisions or running aground.
	When a large value is set as an association condition, a tracked target near an AIS target is identified as the AIS target and may thus disappear from the display. For example, when a pilot vessel equipped with the AIS function (a small target which is not a tracked target) goes near a cargo vessel which is a tracked target without the AIS function, the tracked target symbol for the cargo vessel may disappear.

# CAUTION

	<p>Since these alarms may include some errors depending on the target tracking conditions, the navigation officer himself should make the final decision for ship operations such as collision avoidance.</p> <p>Making the final navigation decision based only on the alarm may cause accidents such as collisions.</p>
	<p>When setting an automatic acquisition zone, make sure to properly adjust gain, sea-surface reflection suppression level, and rain/snow reflection suppression level so that the optimal target images are always on the radar screen. The automatic acquisition zone alarm will not be activated for targets undetected by the radar, and it may result in accidents such as collisions.</p>
	<p>Any adjustments must be made by specialized service personnel. Incorrect settings may result in unstable operation.</p>
	<p>Do not make any adjustments during navigation. Failure to comply may result in adverse effects on the radar function which may lead to accidents or equipment failure.</p>
	<p>Any adjustments must be made by specialized service personnel. Failure to comply may result in accidents or equipment failure.</p>
	<p>Make sure to shut off the main power before replacing parts. Failure to comply may result in electrocution or equipment failure.</p>
	<p>When replacing magnetrons, make sure to shut off the main power and let the equipment stand for more than 5 minutes to discharge the high-voltage circuit.</p> <p>Failure to comply may result in electrocution.</p>
	<p>Make sure to take off your watch when your hand must get close to the magnetron.</p> <p>Failure to comply may result in damage to the watch since the magnetron is a strong magnet.</p>
	<p>When cleaning the display screen, do not wipe it too strongly with a dry cloth. Also, do not use gasoline or thinner to clean the screen.</p> <p>Failure to comply will result in damage to the screen surface.</p>
	<p>Do not take apart, and do not remodel the display unit. It may cause a fire, the electric shock, and the breakdown.</p>
	<p>Before using a USB memory to read or write files, make sure that there are no computer viruses in the USB memory. If the display unit is infected with a virus, it may affect other equipment and cause a failure.</p>

	<p>When removing the USB memory, check the USB memory access lamp to make sure that the USB memory is not being accessed before removing it.</p> <p>If you insert or remove the USB memory during access, the data may be damaged and a failure may occur.</p>
	<p>The USB ports prepared on the front panel side and the back panel side are limited to a maximum of 500 [mA] based on the USB 2.0 standard.</p> <p>If a device with a current consumption exceeding 500 [mA] is connected to this port for the purpose of charging electronic devices, etc., the current limit circuit may operate and the USB port may be temporarily unavailable.</p>
	<p>Do not insert chart cards and data SD cards other than properly arranged new pec/Navionics+ into the CHART card slot.</p> <p>If the display unit infects with a computer virus via SD card, it may affect other equipment and cause a malfunction.</p>
	<p>The waterproof performance of the display unit is IPX5. For the operating conditions to guarantee this performance, refer to the integrated display unit waterproofing specification in Chapter 12 of this manual.</p> <p>If the operating conditions are not observed, the waterproof performance is not guaranteed and may cause fire, electric shock, or failure.</p>
	<p>OS (Operating System) incorporate in the display unit. Be sure to turn off the power with power off operation (refer to the section 2.3 POWER ON/OFF) .</p> <p>If the operating is not observed, some setting values force to initialize values, or numerical and icons are not displayed by the software files broken depending on the software work situation.</p>

# WARNING LABEL MOUNTING POINT

Warning label is patched on the equipment visible surface.  
Do not try to remove, break or modify the label.

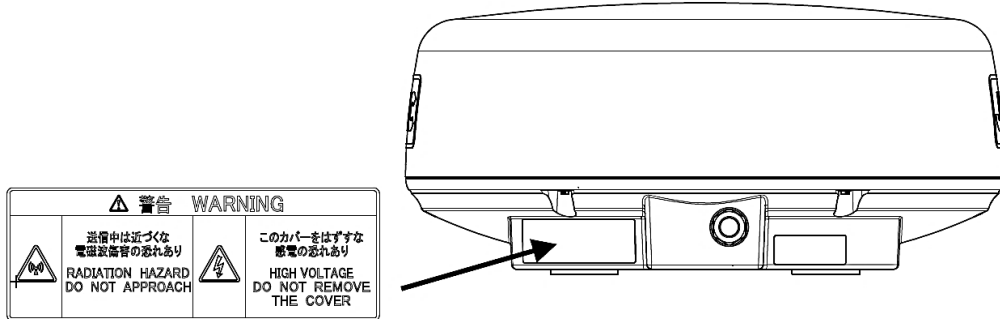

## NKE-2043 SCANNER UNIT

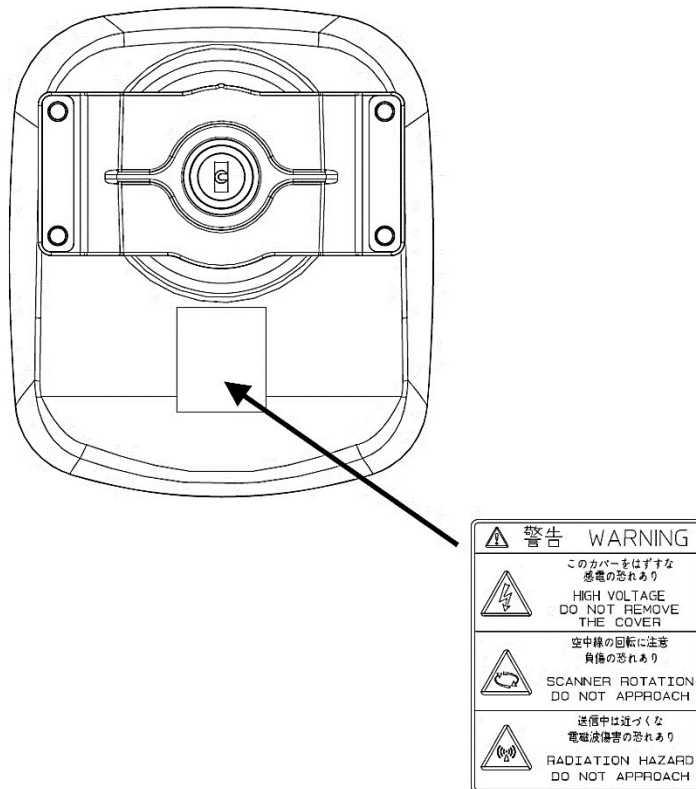

## NKE-2063A/AHS SCANNER UNIT

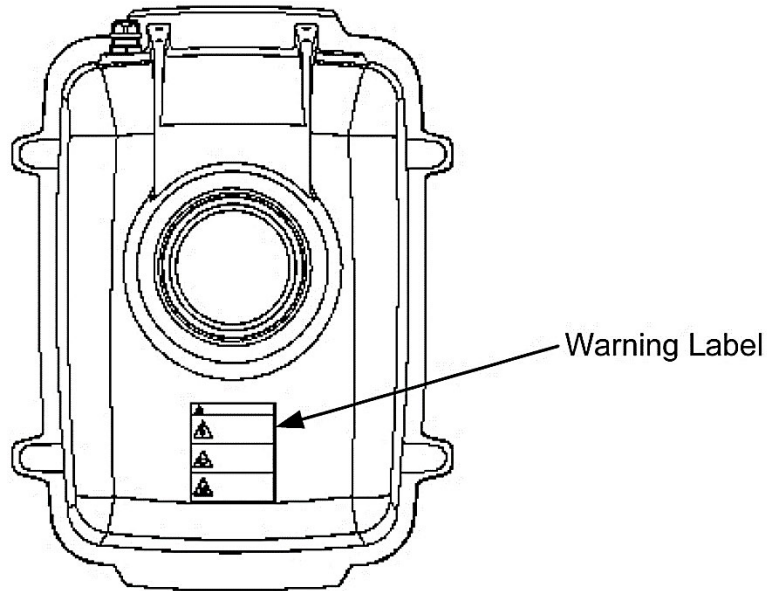

**NKE-2103-4/4HS/6/6HS SCANNER UNIT**

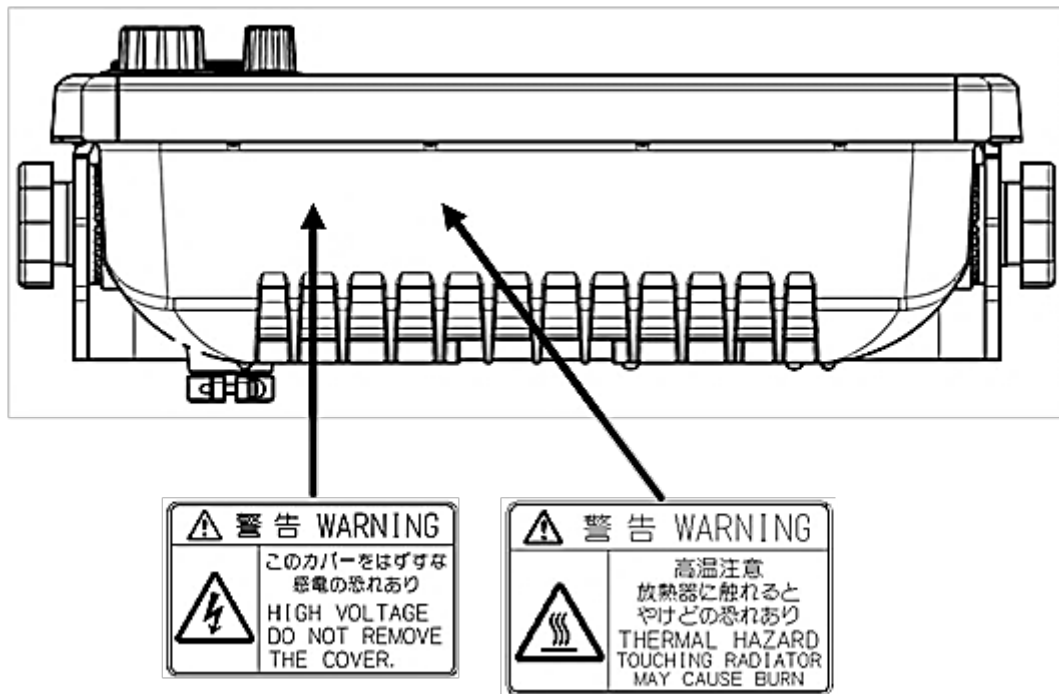







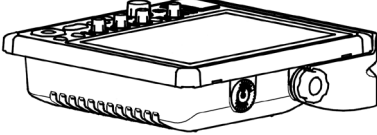

**NCD-2364 DISPLAY UNIT**

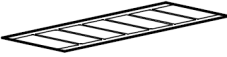
# PACKING LIST

The packing lists of each unit are as follows.

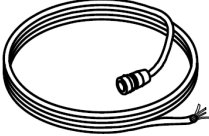

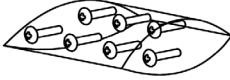
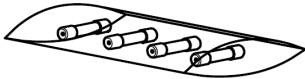





## NCD-2364 : Display unit

Parts Name	Figure	Qty.
Packing List [MTZ305402]		1
Display Unit [NCD-2364]		1
Sun Cover		1
Name Plate		1
Readme		1
Simplified Manual (English edition) [7ZPRD1010*]		1
Instruction Manual (English edition) [7ZPRD1007*]		1
Power Cable [CFQ-7758]		1
Template		1
Screw Size 6 × 25		7
Fuse 5A product : 2 pieces 10A product : 2 pieces		4

“ \* ” means revision, such as A, B and so on.





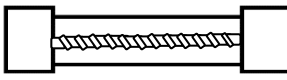
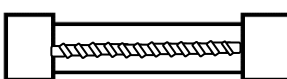





**NKE-2043: SCANNER UNIT**

Parts Name		Figure	Qty.
Packing List [MTZ304378*]			1
Scanner Unit [NKE-2043]			1
Mounting Hardware [MPXP34826*]	Bolt [M8X30 SUS304]		4
	Spring Washer [SW8 SUS]		4
	Washer [W8 SUS]		4
	Instruction for Equipment [MTZ304377*]		1
Template [MTZ302447*]			1
Installation Cable (Option) 5, 10, 15, 20, 30m [5m:CFQ-6912-5] / [10m:CFQ-6912-10] / [15m:CFQ-6912-15] / [20m:CFQ-6912-20] / [30m:CFQ-6912-30]			1
Fuse [7ZXR0012]	[ST4-6.3AN1] Scanner NKE-2043(DC12V) For the compound modulator(F2) JRC CODE: 5ZFCA00051 1 for installation / 3 for spares		4
	[ST4-3.15AN1] Scanner NKE-2043(DC24V) For the compound modulator(F2) JRC CODE: 5ZFCA00047 1 for installation / 3 for spares		4



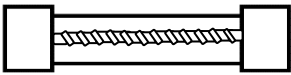
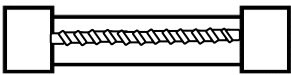
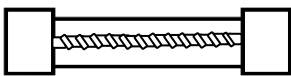





“ \* ” means revision, such as A, B and so on.

**NKE-2063A/AHS: SCANNER UNIT**

Parts Name		Figure	Qty.
Packing List [MTZ305173*]			1
Scanner Unit [NKE-2063A/AHS]			1
Mounting Hardware [MPXP35725*]	Brass Washer [MTL325583]		4
	Built-in Upset Bolt [M6X12SUS+SW+W]		4
	Instruction for Equipment [MTZ305172*]		1
Installation Cable (Option) 5, 10, 15, 20, 30m [5m:CFQ-6912-5] / [10m:CFQ-6912-10] / [15m:CFQ-6912-15] / [20m:CFQ-6912-20] / [30m:CFQ-6912-30]			1
Earth Cable [7ZCRD1501]			1
Fuse [7ZXRD0013]	[ST4-6.3AN1] Scanner NKE-2062(DC12V) For the modulator(F2) JRC CODE: 5ZFCA00051 1 for installation / 3 for spares		4
	[ST4-3.15AN1] Scanner NKE-2062/HS(DC24V) For the modulator(F2) JRC CODE: 5ZFCA00047 1 for installation / 3 for spares		4
	[ST4-5AN1] Scanner NKE-2062/HS For the scanner motor(F3) JRC CODE: 5ZFCA00050 1 for installation / 3 for spares		4
Carbon Brush [54531-01]			2

“ \* ” means revision, such as A, B and so on.

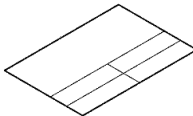

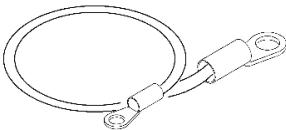
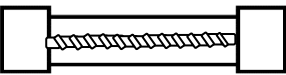
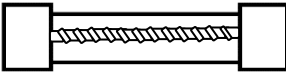

**NKE-2103-4/4HS/6/6HS: SCANNER UNIT**

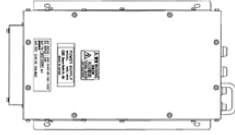

Parts Name		Figure	Qty.
Packing List [MTZ303832*]			1
Scanner Unit [NKE-2103-4/4HS]			1
[NKE-2103-6/6HS]			
Mounting Hardware [MPXP34097*]	Brass Washer [MTL325583]		4
	Built-in Upset Bolt [M6X12SUS+SW+W]		4
	Instruction for Equipment [MTZ303800*]		1
	Name Plate [MPNN45926*]		1
Installation Cable (Option) 5, 10, 15, 20, 30m [5m:CFQ-6912-5] / [10m:CFQ-6912-10] / [15m:CFQ-6912-15] / [20m:CFQ-6912-20] / [30m:CFQ-6912-30]			1
Earth Cable [7ZCRD1501]			1
Fuse [7ZXR00026]	[ST4-5AN1] Scanner NKE-2103-4/4HS/6/6HS For the modulator(F2) JRC CODE: 5ZFCA00050 1 for installation / 3 for spares		4
	[ST6-10AN1] Scanner NKE-2103-4/4HS/6/6HS For the power supply to motor(F3) JRC CODE: 5ZFCA00053 1 for installation / 3 for spares		4

“ \* ” means revision, such as A, B and so on.

**OPTION PARTS**

**PACKING LIST**

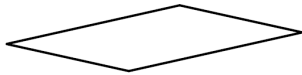
Parts Name	Figure	Qty.
<b>Rectifier</b> <b>[NBA-5111]</b> <b>for JMA-3404</b> <b>JMA-3406/HS</b> <b>JMA-3412-4/4HS/6/6HS</b>		<b>1</b>
<b>Rectifier</b> <b>[NBD-865]</b> <b>for JMA-3404</b> <b>JMA-3406</b>		<b>1</b>
<b>NMEA Cable for GPS</b> <b>[CFQ-9002]</b>		<b>1</b>
<b>NMEA Cable for NMEA0183</b> <b>[CFQ-5374]</b>		<b>1</b>
<b>NMEA Cable for CAN</b> <b>Connector (Socket side- Socket</b> <b>side)</b> <b>[CFQ-7765]</b>		<b>1</b>
<b>Rubber Cap for Installation Cable</b> <b>[MTT317838*]</b>		<b>1</b>
<b>new pec Chart Card</b> <b>[CDD-812]</b> <b>* JRC dedicated card</b>		<b>1</b>
<b>Navionics+ Chart Card</b> <b>*Please consult with our sales</b> <b>office if you need them.</b>		<b>1</b>
<b>USB Memory</b> <b>[UDG4-1GAR-JRC]</b>		<b>1</b>

Parts Name	Figure	Qty.
<b>Simplified Manual (Japanese edition. For products sold in Japan)</b> [7ZPRD1009*]		<b>1</b>
<b>Instruction Manual (Japanese edition. For products sold in Japan)</b> [7ZPRD1006*]		<b>1</b>

“ \* ” means revision, such as A, B and so on.

# EQUIPMENT APPEARANCE

JMA-3400 is a series name.

Individual TYPE name is changed by combination of units.

<b>TYPE</b>	<b>JMA-3404</b>	<b>NCD-2364 + NKE-2043</b>
<b>TYPE</b>	<b>JMA-3406</b>	<b>NCD-2364 + NKE-2063A/AHS</b>
<b>TYPE</b>	<b>JMA-3411-4</b>	<b>NCD-2364 + NKE-2103-4/4HS</b>
<b>TYPE</b>	<b>JMA-3411-6</b>	<b>NCD-2364 + NKE-2103-6/6HS</b>

## JMA-3400 Series system diagram

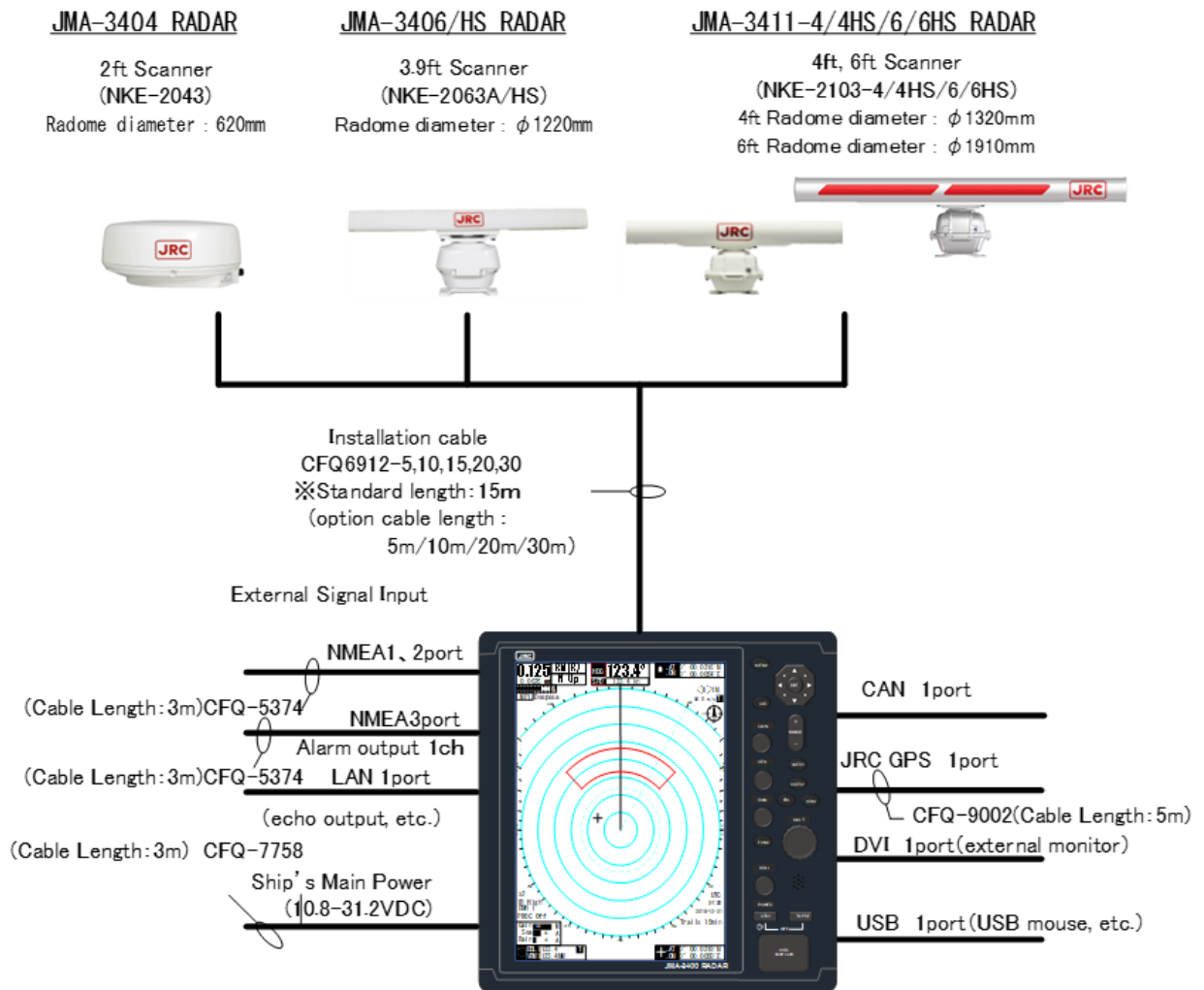

12inch SVGA COLOR LCD DISPLAY

(NCD-2364)

## NKE-2043 SCANNER UNIT

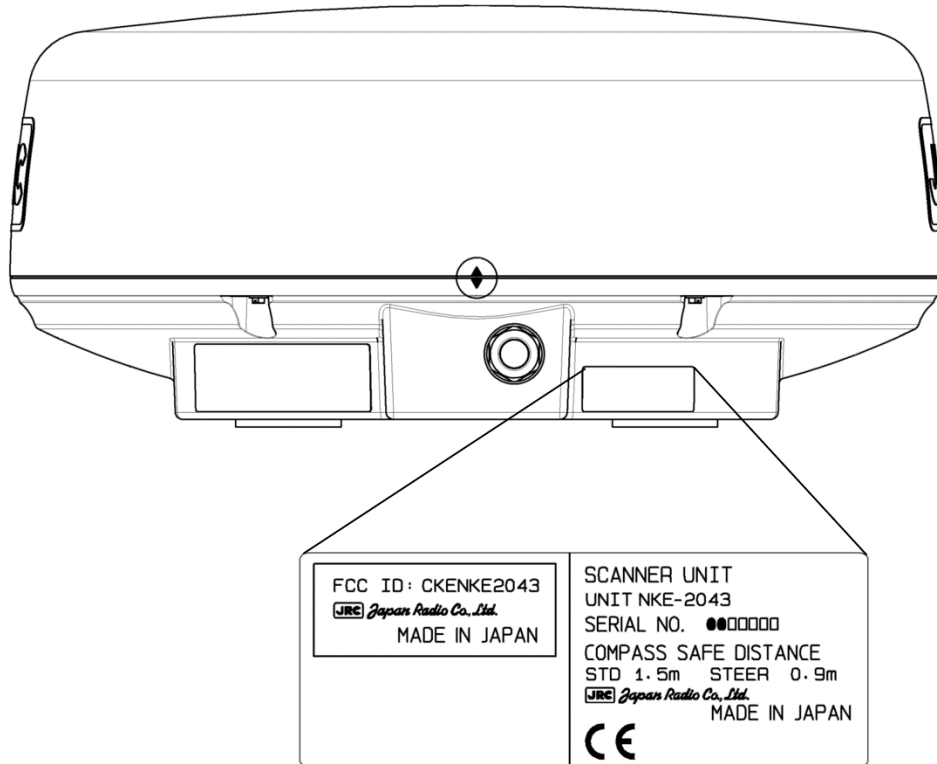

## NKE-2063A/AHS SCANNER UNIT

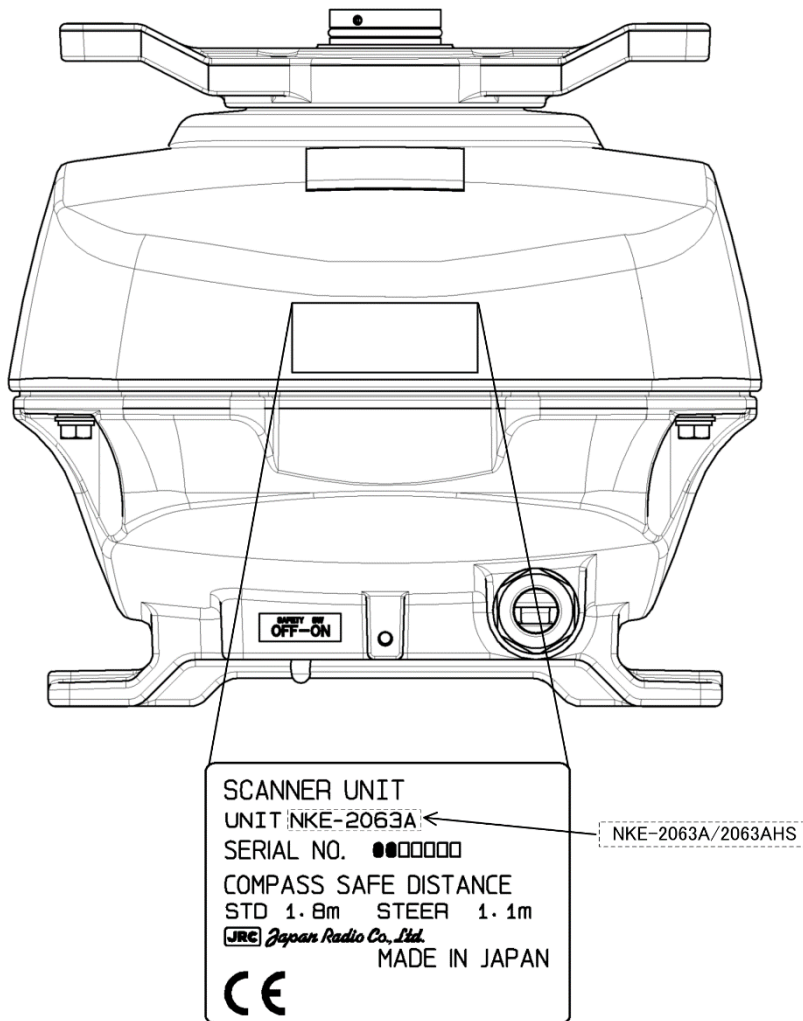

# NKE-2103-4/4HS/6/6HS SCANNER UNIT

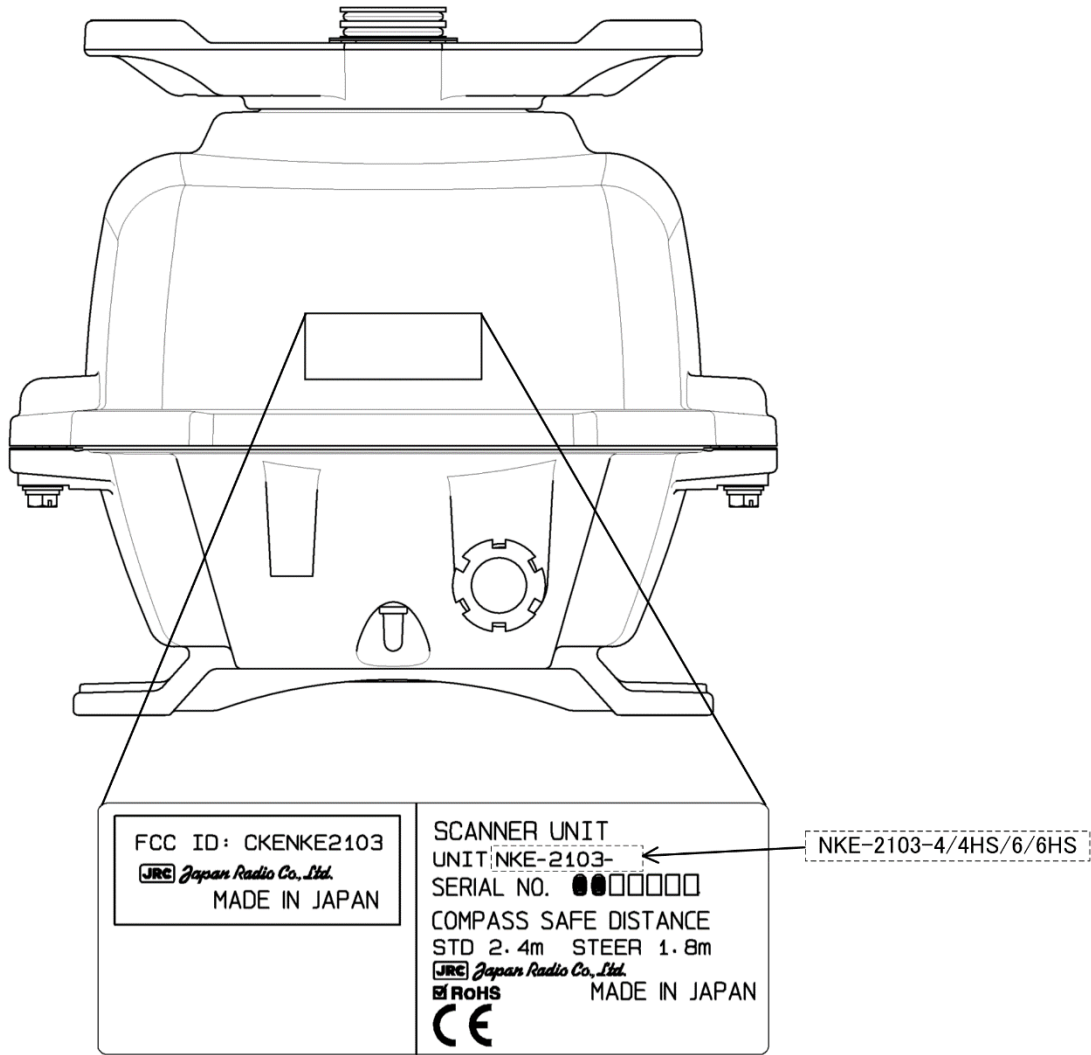



# NCD-2364 DISPLAY UNIT

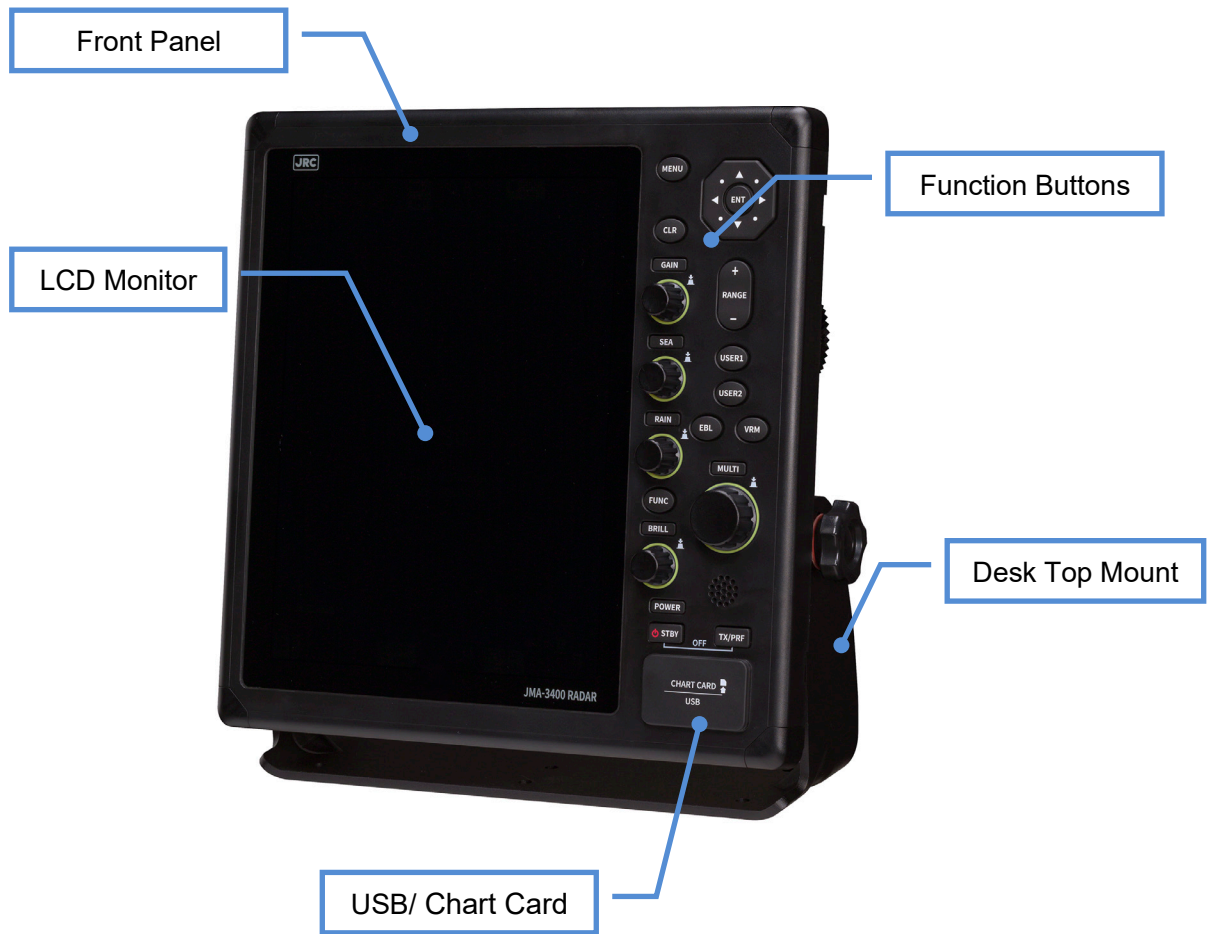

## With Sun Cover

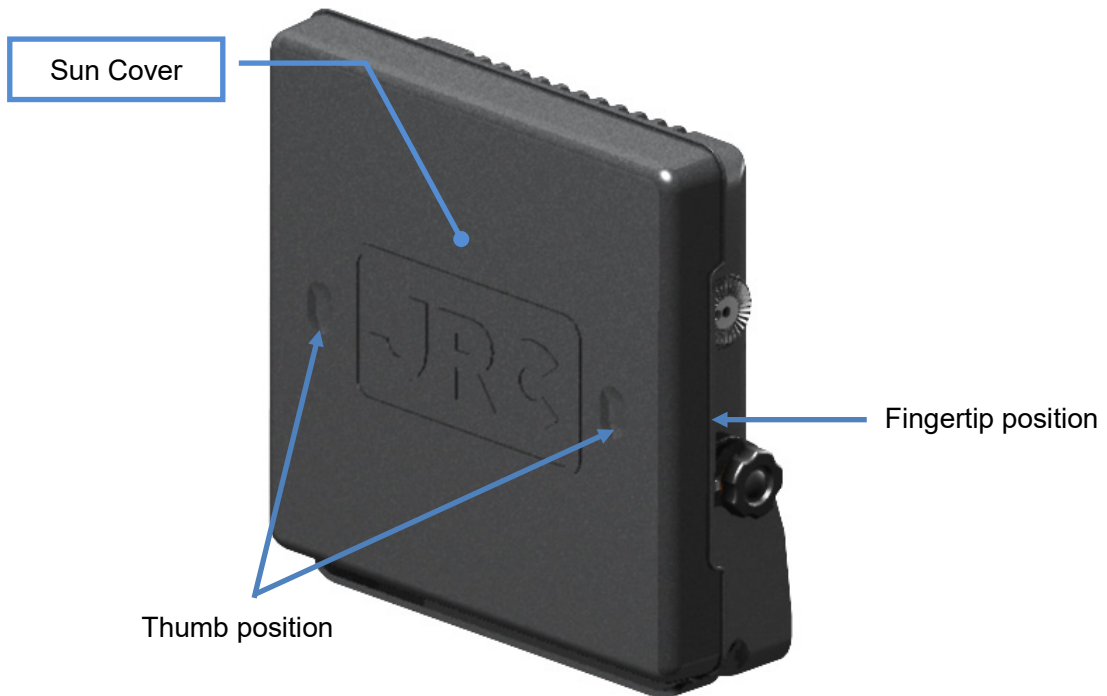

**Note:** When you remove the sun cover do the thumb position push and the fingertip position pull at the same time action.

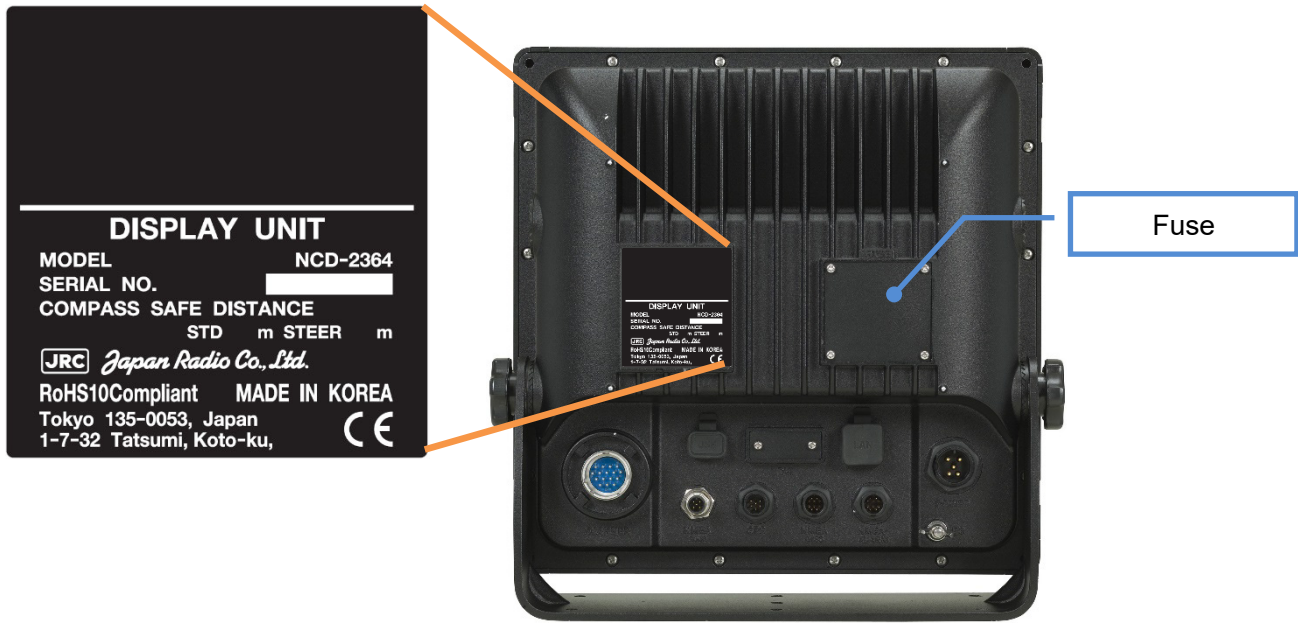

(MEMO)

# CONTENTS

<b>PRECAUTIONS BEFORE OPERATION</b> .....	<b>i</b>
<b>FIRST-AID TREATMENTS</b> .....	<b>ii</b>
<b>PREFACE</b> .....	<b>x</b>
<b>CHECKING THE SUPPLIED ITEMS</b> .....	<b>x</b>
<b>BEFORE OPERATION</b> .....	<b>xi</b>
<b>PRECAUTIONS</b> .....	<b>xv</b>
<b>WARNING LABEL MOUNTING POINT</b> .....	<b>xx</b>
<b>PACKING LIST</b> .....	<b>xxii</b>
<b>EQUIPMENT APPEARANCE</b> .....	<b>xxviii</b>
<b>CONTENTS</b> .....	<b>xxxiv</b>
<b>GLOSSARY</b> .....	<b>xliii</b>
<b>Chapter 1 INSTALLATION</b> .....	<b>1</b>
1.1 OVERVIEW .....	1
1.2 INSTALLATION OF THE DISPLAY UNIT .....	2
1.2.1 SELECTING THE INSTALLATION POSITION .....	2
1.2.2 SELECTION OF DISPLAY MOUNTING .....	2
1.2.3 DIMENSIONAL DRAWING OF DISPLAY MOUNTING.....	3
1.2.4 EXAMPLES OF DISPLAY MOUNTING .....	5
1.2.5 POWER CABLE INSTALLATION .....	9
1.2.6 EXTERNAL NAVIGATIONAL SIGNAL CONNECTION.....	10
1.3 INSTALLATION OF THE SCANNER UNIT .....	12
1.3.1 SELECTING THE INSTALLATION POSITION .....	12
1.3.2 LOWEST SCANNER INSTALLATION HEIGHT .....	13
1.3.3 MOUNTING RACK AND MAST FOR THE SCANNER.....	14
1.3.4 SCANNER AND THE SURROUNDING STRUCTURAL OBJECTS .....	14
1.3.5 ENSURING VIEW ANGLE.....	15
1.3.6 CONFIRM MOUNTING BASE BEFORE INSTALL .....	17
1.4 CONNECTING THE INSTALLATION CABLE .....	23
1.4.1 NKE-2043 SCANNER (2 FEET) .....	24
1.4.2 NKE-2063A SCANNER (3.9 FEET) .....	28
1.4.3 NKE-2063AHS SCANNER (3.9 FEET) .....	31
1.4.4 NKE-2103-4/6 SCANNER (4 FEET/6 FEET) .....	34
<b>Chapter 2 THE BASIC OPERATION</b> .....	<b>36</b>
2.1 PANEL AND SCREEN DISPLAY LAYOUT .....	36
2.2 OPERATION UNIT .....	37
2.3 POWER ON/OFF .....	41
2.4 SCREEN LAYOUT.....	43
2.4.1 STANDBY SCREEN .....	43

2.4.2 TRANSMISSION SCREEN .....	45
2.5 MULTI CONTROL OPERATION .....	46
2.5.1 FUNCTION OVERVIEW OF MULTI CONTROL MENU .....	48
<b>Chapter 3 ADJUST THE RADAR ECHO .....</b>	<b>49</b>
3.1 CHANGE RANGE .....	49
3.2 SENSITIVITY ADJUSTMENT (GAIN) .....	50
3.3 SEA CLUTTER SUPPRESSION (SEA) .....	51
3.4 RAIN/SNOW CLUTTER SUPPRESSION (RAIN) .....	52
3.5 SCREEN BRILLIANCE (BRILL) .....	53
<b>Chapter 4 VRM AND EBL FUNCTION .....</b>	<b>54</b>
4.1 OPERATION OF VRM, EBL .....	54
4.2 EXAMPLE OF VRM FUNCTION .....	54
4.3 EXAMPLE OF EBL FUNCTION .....	55
<b>Chapter 5 VARIOUS FUNCTIONS .....</b>	<b>56</b>
5.1 PARALLEL CURSOR FUNCTION .....	56
5.2 MOB FUNCTION (MAN OVERBOARD) .....	59
5.3 ANCHOR WATCH FUNCTION .....	60
5.4 VECTOR LENGTH .....	62
5.5 RADAR TRAILS .....	63
5.5.1 SETUP THE RADAR TRAILS INTERVAL .....	63
5.6 AIS OPERATIONS .....	64
5.6.1 AIS LIST .....	66
5.7 TT OPERATIONS .....	68
5.8 OFF-CENTER FUNCTION .....	73
5.9 MARK FUNCTION .....	73
5.10 LINE FUNCTION .....	76
5.11 OWNERSHIP MARK FUNCTION .....	79
5.12 USER OPTION KEYS .....	81
5.13 MODE FUNCTION .....	82
5.14 SETTING DISPLAY BRILLIANCE AND COLOR .....	84
5.15 CURSOR FUNCTION .....	85
5.16 RADAR ECHO SETTING .....	86
5.16.1 PULSE WIDTH .....	87
5.16.2 IR (INTERFERENCE REJECTION) .....	87
5.16.3 TARGET ENHANCE .....	88
5.16.4 PROCESS .....	88
5.16.5 ZOOM MODE .....	88
5.16.6 VIDEO NOISE REJECTION .....	89
5.16.7 VIDEO LATITUDE .....	89
5.17 TUNE .....	90
5.18 MARKER .....	91
5.18.1 EBL SETTING .....	91

5.18.2	PARALLEL CURSOR .....	92
5.18.3	VRM UNIT .....	93
5.18.4	CURSOR MODE .....	93
5.18.5	RANGE RING .....	94
5.19	SET OWN SHIP MOVEMENT .....	95
5.20	TRAILS SETTING .....	96
5.20.1	THRESHOLD .....	97
5.20.2	TIME/ALL COMBINE .....	97
5.20.3	TRAILS MODE .....	97
5.21	VECTOR .....	98
5.21.1	VECTOR MODE .....	98
5.21.2	DISPLAY OWN SHIP'S VECTOR .....	98
5.21.3	OWN SHIP VECTOR LINE WIDTH .....	99
5.22	OFFCENTER SETTING .....	99
5.23	FUNCTION SETTING .....	100
5.23.1	FUNCTION ENABLE/DISABLE .....	101
5.23.2	AUTO STC/FTC .....	101
5.23.3	TRAILS INTERVAL .....	102
5.23.4	ANTENNA HEIGHT .....	102
5.23.5	SAVE PRESENT STATE .....	102
5.23.6	Reset To User Default .....	102
5.23.7	INITIALIZE .....	103
5.24	AIS/TT .....	104
5.24.1	COLLISION AVOIDANCE .....	104
5.24.2	FUNCTION ON/OFF .....	108
5.24.3	CPA LIMIT .....	108
5.24.4	TCPA LIMIT .....	108
5.24.5	CPA RING .....	108
5.24.6	TARGET NUMBER DISPLAY .....	108
5.24.7	TARGET NUMBER ALLOCATION .....	109
5.24.8	TLL TARGET NUMBER ALLOCATION .....	109
5.24.9	ALR ALARM FROM AIS .....	109
5.24.10	AIS DISPLAY TARGET .....	109
5.24.11	AIS DESTINATION SHIP .....	109
5.24.12	AIS RETRIEVED VESSEL .....	109
5.24.13	AIS FILTER .....	109
5.25	GUARD ZONE .....	110
5.25.1	ZONE ALARM LEVEL .....	111
5.25.2	ZONE MODE .....	111
5.25.3	MAKE ZONE .....	111
5.26	WAYPOINT DISPLAY .....	112
5.27	CHART .....	113

5.27.1	TYPE.....	113
5.27.2	DISPLAY.....	114
5.27.3	SYMBOL.....	114
5.27.4	PALETTE.....	114
5.27.5	SHOW EXTEND DATA.....	114
5.28	SET CHART OPERATION.....	115
5.29	MARK SETTING.....	116
5.29.1	MARK SIZE.....	116
5.29.2	MARK COLOR.....	116
5.29.3	MARK TYPE.....	117
5.29.4	DISPLAY MARK COLOR.....	117
5.29.5	DISPLAY MARK TYPE.....	117
5.29.6	MARK LIST.....	117
5.30	OWNSHIP MARK SETTING.....	119
5.30.1	OWN SHIP POSITION MARK SIZE.....	119
5.30.2	OWN SHIP POSITION MARK COLOR.....	119
5.30.3	OWN SHIP POSITION MARK TYPE.....	120
5.30.4	DISPLAY MARK COLOR.....	120
5.30.5	DISPLAY MARK TYPE.....	120
5.30.6	OWN SHIP POSITION MARK LIST.....	120
5.31	LINE SETTING.....	122
5.31.1	LINE COLOR.....	122
5.31.2	LINE TYPE.....	122
5.31.3	DISPLAY LINE COLOR.....	122
5.31.4	DISPLAY LINE TYPE.....	123
5.31.5	LINE LIST.....	123
5.32	OWN TRACK SETTING.....	125
5.32.1	OWN TRACK RECORD ON/OFF.....	125
5.32.2	OWN TRACK RECORD DISPLAY ON/OFF.....	125
5.32.3	OWN TRACK COLOR.....	126
5.32.4	OWN TRACK TYPE.....	126
5.32.5	OWN TRACK INTERVAL.....	126
5.32.6	DISPLAY OWN TRACK COLOR.....	126
5.32.7	DISPLAY OWN TRACK TYPE.....	126
5.32.8	CLEAR OWN TRACK COLOR/TYPE.....	126
5.33	FILE OPERATION.....	127
5.33.1	SAVE.....	127
5.33.2	LOAD.....	127
5.33.3	DELETE.....	127
5.34	SCREEN CAPTURE.....	128
5.34.1	CAPTURE FUNCTION.....	129
5.34.2	SET MANUAL KEY.....	129

5.34.3 INTERVAL .....	129
5.35 TIMED TX .....	130
5.35.1 TIMED TX .....	130
5.35.2 TX TIME .....	130
5.35.3 STANDBY TIME .....	131
5.36 TLL TX "USER2" .....	131
5.37 CERTIFICATION INFORMATION .....	131
<b>Chapter 6 OPTION AND OTHER FUNCTIONS .....</b>	<b>132</b>
6.1 NMEA CABLE .....	132
6.2 EXTERNAL MONITOR OUTPUT .....	135
6.3 RECTIFIER UNIT .....	135
<b>Chapter 7 INITIAL SETTINGS .....</b>	<b>136</b>
7.1 LANGUAGE SELECTION .....	137
7.2 BEARING ADJUSTMENT .....	137
7.3 RANGE ADJUSTMENT .....	138
7.4 TUNING ADJUSTMENT .....	139
7.5 ANTENNA HEIGHT SET UP .....	139
7.6 COMMUNICATION PORT SETUP .....	140
7.6.1 BAUD RATE .....	141
7.6.2 RX SENTENCE .....	141
7.6.3 RX PORT .....	142
7.6.4 TX PORT .....	142
7.6.5 TX DATA FORMAT .....	143
7.6.6 TARGET INFORMATION TX .....	143
7.7 I/F DEVICE .....	144
7.7.1 HEADING EQUIPMENT .....	145
7.7.2 MANUAL HEADING .....	146
7.7.3 SPEED EQUIPMENT .....	146
7.7.4 MANUAL SPEED .....	146
7.7.5 MAGNETIC COMPASS .....	146
7.8 JRC GPS .....	147
7.8.1 NMEA VERSION .....	147
7.8.2 GPS SETTING .....	148
7.8.3 BEACON SETTING .....	152
7.8.4 SBAS SETTING .....	153
7.8.5 GPS STATUS DISPLAY .....	154
7.8.6 LORAN SETTING .....	154
<b>Chapter 8 DETAIL PERFORMANCE SETTINGS .....</b>	<b>155</b>
8.1 RADAR ECHO .....	155
8.1.1 NOISE LEVEL .....	156
8.1.2 MAIN BANG SUPPRESSION .....	156
8.1.3 TARGET ENHANCE LEVEL .....	157



8.1.4	GAIN .....	157
8.1.5	SEA.....	157
8.1.6	RAIN .....	158
8.2	TRAILS .....	159
8.2.1	TRAILS SUPPRESSION DISTANCE.....	159
8.2.2	MAX INTERVAL.....	160
8.2.3	RANGE LIMIT .....	160
8.3	TARGET TRACKING (TT).....	161
8.4	SCANNER .....	162
8.4.1	SLOPE CORRECTION .....	163
8.4.2	PULSE REPETITION FREQUENCY FINE TUNING (PRF FINE TUNING) ...	163
8.4.3	STAGGER TRIGGER .....	163
8.4.4	SCANNER ROTATION SPEED.....	163
8.4.5	PRF OUTPUT MODE .....	163
8.4.6	SAFETY SWITCH.....	163
8.4.7	TUNE PEAK ADJUSTMENT.....	164
8.4.8	TUNE INDICATOR LEVEL .....	164
8.4.9	STOP ANTENNA IN THE SPECIFIED DIRECTION .....	164
8.4.10	ICE CLASS STANDBY MODE.....	164
8.5	CONTROL .....	165
8.5.1	MULTI CONTROL MENU TIME OUT .....	165
8.5.2	CROSS KEY GAIN .....	165
8.5.3	MULTI CONTROL.....	166
8.5.4	GAIN CONTROL/SEA CONTROL/RAIN CONTROL .....	166
8.6	BUZZER .....	167
8.7	MAINTENANCE.....	168
8.7.1	RESET PARTIAL .....	169
8.7.2	MASTER RESET .....	170
8.7.3	SYSTEM TIME CLEAR.....	170
8.7.4	SCANNER TIME CLEAR.....	171
8.7.5	TABLE UPDATE .....	172
8.7.6	INTERNAL SETTING.....	172
8.7.7	USB FORMAT .....	174
8.8	SYSTEM SETTING.....	175
8.8.1	MASTER/SLAVE/DEMO .....	176
8.8.2	OWN OUTLINE.....	176
8.8.3	BARGE OUTLINE.....	176
8.8.4	BEARING MARKER.....	176
8.8.5	OPERATION NUMERIC DISPLAY .....	176
8.8.6	UNIT.....	177
8.8.7	MOVE OWN SHIP .....	177
8.8.8	RANGE .....	178

8.9	DISPLAY SCREEN.....	179
8.9.1	STANDBY NUMERIC DISPLAY .....	180
8.9.2	DISPLAY COLOR.....	180
8.9.3	OPERATION NUMERIC DISPLAY .....	181
8.9.4	WIDE SCREEN.....	182
8.9.5	TIME .....	182
8.10	RADAR ECHO COLOR.....	183
8.11	ERROR ALARM MASK .....	184
8.11.1	SCANNER .....	185
8.11.2	DISPLAY UNIT.....	185
8.11.3	CONNECTION DEVICE.....	186
8.11.4	RX DATA .....	186
8.12	NETWORK .....	187
8.12.1	NETWORK SETTING.....	188
8.12.2	NETWORK FUNCTION .....	190
8.12.3	IP ADDRESS .....	190
8.12.4	RADAR ECHO TRANSMISSION SETTING .....	190
8.13	CAN .....	192
8.13.1	CAN OUT .....	192
8.13.2	CAN PGN.....	193
	<b>Chapter 9 TRUE OR FALSE ECHOS ON DISPLAY .....</b>	<b>194</b>
9.1	RADAR WAVE WITH THE HORIZON .....	194
9.2	REFLECTION FROM TARGET .....	195
9.3	SEA CLUTTER AND RAIN AND SNOW CLUTTER.....	196
9.3.1	SEA CLUTTER.....	196
9.3.2	RAIN AND SNOW CLUTTER .....	196
9.3.3	COPING WITH SEA CLUTTER AND RAIN AND SNOW CLUTTER.....	196
9.4	FALSE ECHOES .....	197
9.4.1	SHADOW .....	197
9.4.2	SIDE LOBE EFFECT .....	197
9.4.3	FALSE ECHO BY SECONDARY REFLECTION.....	197
9.4.4	FALSE ECHO BY MULTIPLE REFLECTION.....	198
9.4.5	SECOND TIME ECHOES .....	198
9.4.6	RADAR INTERFERENCE .....	198
9.5	DISPLAY OF RADAR TRANSPONDER(SART) .....	199
	<b>Chapter 10 MAINTENANCE AND CHECK.....</b>	<b>200</b>
10.1	ROUTINE MAINTENANCE.....	200
10.2	MAINTENANCE OF EACH UNIT.....	201
10.2.1	SCANNER UNIT NKE-2043, 2063A/AHS, 2103-4/4HS/6/6HS .....	201
10.2.2	DISPLAY NCD-2364 .....	203
10.3	PERFORMANCE CHECK .....	203
10.3.1	TEST-SYSTEM INFORMATION .....	205

10.3.2	SYSTEM INFORMATION .....	205
10.3.3	SYSTEM TIME.....	205
10.3.4	SCANNER INFORMATION .....	206
10.3.5	HARDWARE INFORMATION .....	206
10.3.6	ERROR LOG .....	206
10.3.7	LINE MONITOR .....	206
10.3.8	SELF TEST .....	207
10.3.9	SOFTWARE UPDATE .....	208
10.4	REPLACEMENT OF MAJOR PARTS.....	209
10.4.1	PARTS REQUIRED FOR PERIODIC REPLACEMENT.....	210
10.5	FAULT FINDING.....	211
10.5.1	ALARMS AND OTHER DISPLAY LISTS .....	211
10.6	TROUBLE SHOOTING.....	217
10.6.1	SPECIAL PARTS.....	217
10.6.2	CIRCUIT BLOCK TO BE REPAIRED .....	219
<b>Chapter 11</b>	<b>AFTER-SALE SERVICE .....</b>	<b>221</b>
11.1	KEEPING PERIOD OF MAINTENANCE PARTS .....	221
11.2	WHEN YOU REQUEST FOR REPAIR.....	221
11.3	RECOMMENDED MAINTENANCE .....	221
11.4	RADAR FAILURE CHECK LIST .....	222
<b>Chapter 12</b>	<b>DISPOSAL .....</b>	<b>223</b>
12.1	DISPOSAL OF THE UNIT .....	223
12.2	DISPOSAL OF USED MAGNETRON.....	223
12.3	CHINA ROHS .....	223
<b>Chapter 13</b>	<b>SPECIFICATIONS .....</b>	<b>224</b>
13.1	SCANNER DIMENSION .....	225
13.1.1	NKE-2043 .....	225
13.1.2	NKE-2063A/AHS.....	226
13.1.3	NKE-2103-4/4HS .....	227
13.1.4	NKE-2103-6/6HS .....	228
13.2	DISPLAY DIMENSION .....	229
13.2.1	NCD-2364 .....	229
13.3	EQUIPMENT OUTLINE .....	230
13.3.1	CONFIGULATION.....	230
13.3.2	FEATURE .....	230
13.3.3	RADAR MODEL.....	230
13.4	GENERAL SPECIFICATIONS .....	231
13.5	SCANNER .....	231
13.5.1	SCANNER (NKE-2043) SPECIFICATION .....	233
13.5.2	SCANNER (NKE-2063A/AHS) SPECIFICATION .....	234
13.5.3	SCANNER (NKE-2103-4/6/4HS/6HS) SPECIFICATION .....	235
13.6	DISPLAY.....	236

13.6.1 INTEGRATED DISPLAY UNIT (NCD-2364) .....	236
13.6.2 OPERATIONAL PART .....	239
13.6.3 AIS FUNCTION (STANDARD BUILT IN) .....	240
13.6.4 TT FUNCTION (STANDARD BUILT IN) .....	240
13.7 INPUT/ OUTPUT SIGNAL .....	241
13.7.1 INPUT ENABLE SIGNAL .....	241
13.7.2 OUTPUT POSSIBLE SIGNAL .....	242
13.7.3 STANDARD CONFIGURATION .....	242
13.7.4 OPTION CABLE.....	242
<b>APPENDIX .....</b>	<b>2</b>
NKE-2043 SCANNER INTERCONNECTION DIAGRAM.....	2
NKE-2063A SCANNER INTERCONNECTION DIAGRAM .....	3
NKE-2063AHS SCANNER INTERCONNECTION DIAGRAM .....	4
NKE-2103-4/4HS/6/6HS SCANNER INTERCONNECTION DIAGRAM .....	5
NCD-2364 DISPLAY UNIT INTER CONNECTION DIAGRAM .....	6
JMA-3400 PRIMARY POWER SUPPLY DIAGRAM .....	7
JMA-3404 INTERCONNECTION DIAGRAM .....	8
JMA-3406/HS INTERCONNECTION DIAGRAM .....	9
JMA-3411-4/4HS/6/6HS INTERCONNECTION DIAGRAM .....	10
MENU FUNCTION LIST .....	12
DECLARATION OF CONFORMITY .....	29
<b>APPENDIX .....</b>	<b>A1</b>
NKE-2043 SCANNER INTERCONNECTION DIAGRAM.....	A1
NKE-2063A SCANNER INTERCONNECTION DIAGRAM .....	A2
NKE-2063AHS SCANNER INTERCONNECTION DIAGRAM .....	A3
NKE-2103-4/4HS/6/6HS SCANNER INTERCONNECTION DIAGRAM .....	A4
NCD-2364 DISPLAY UNIT INTER CONNECTION DIAGRAM .....	A5
JMA-3400 PRIMARY POWER SUPPLY DIAGRAM .....	A6
JMA-3404 INTERCONNECTION DIAGRAM .....	A7
JMA-3406/HS INTERCONNECTION DIAGRAM .....	A8
JMA-3411-4/4HS/6/6HS INTERCONNECTION DIAGRAM .....	A9
MENU FUNCTION LIST .....	A11
DECLARATION OF CONFORMITY .....	A28

# GLOSSARY

This section describes the main terms used for this equipment and general related maritime terms.

## A

Activated target	A target representing the automatic or manual activation of a sleeping target for the display of additional information.
AIS	Automatic Identification System A system which enables ships and shore stations to obtain identifying and navigation information about other ships at sea, using an automated transponder.
Anti-clutter rain	Rain/snow clutter suppression.
Anti-clutter sea	Sea clutter suppression.
AZ	Acquisition/Activation zone A zone set up by the operator in which the system should automatically acquire radar targets and activate reported AIS targets when entering the zone.
AZI	Azimuth stabilization mode

## B

BCR/BCT	Bow Crossing Range and Bow Crossing Time
Beacon	In this manual it means radio station that is already known accurate position. DGPS use to calculate for higher accuracy than GPS.
Bft.	Beaufort scale 0: Calm, 1: Light air, 2: Light breeze, 3: Gentle breeze, 4: Moderate breeze, 5: Fresh breeze, 6: Strong breeze, 7: High wind, 8: fresh gale, 9: Strong gale, 10: Storm, 11: Violent storm, 12: Hurricane

## C

C-UP	Course up Own ship's course is pointed to the top center of the radar display.
CCRP	The Consistent Common Reference Point A location on own ship, to which all horizontal measurements such as target range, bearing, relative course, relative speed, CPA or TCPA are referenced, typically the conning position of the bridge.
Clutter	Unwanted reflections on a radar screen, from sea surface, rain or snow.
COG	Course Over Ground The direction of the ship's movement relative to the earth, measured on board the ship, expressed in angular units from true north
Compass	A device indicates the direction.
CORREL	Correlation
CPA/TCPA	The distance to the Closest Point of Approach and Time to the Closest Point of Approach. Limits are set by the operator and are related to own ship.
CTW	Course Through Water The direction of the ship's movement through the water

## D

DGPS	Differential Global Positioning System
DRIFT	The current velocity for manual correction or the current speed on the horizontal axis of the 2-axis log is displayed.

## E

EBL	Electronic Bearing Line An electronic bearing line originated from own ship's position.
ENH	Enhance

## GLOSSARY

---

ETA Estimated Time of Arrival

### F

fm Fathom 1fm=1.8288m

FTC Fast Time Constant  
Function of FTC reduces the effect of long duration returns that come from rain or snow.

### G

GPS Global Positioning System  
GPS is a space-based satellite navigation system that provides location and time information in all weather conditions.

Ground stabilization A display mode in which speed and course information are referred to the ground, using ground track input data.

Gyrocompass A gyrocompass is non-magnetic compass which is based on a fast spinning disc and rotation of the Earth to automatically find north and south direction.

### H

HDG Heading  
The horizontal direction that the bow of a ship is pointing at any instant, expressed in angular units from a reference direction.

HDOP Horizontal Dilution of Precision  
The accuracy of the position. If the value is small, the accuracy of position is high.

HL Heading line  
A graphic line on a radar presentation drawn from the consistent common reference point to the bearing scale to indicate the heading of the ship.

H-UP Head up  
Own ship's heading line is always pointed to the top center of the radar display.

### I

IR Radar Interference Rejecter

### L

LL Latitude/ Longitude coordinate system

Log A device measures the speed through the water.

LORAN Long Range Navigation  
A system in which position is determined from the intervals between signal pulses received from widely spaced radio transmitters.

Lost AIS target A target symbol representing the last valid position of an AIS target before the reception of its data was lost, or its last dead-reckoned position.

Lost tracked target One for which target information is no longer available due to poor, lost or obscured signals.

LP Long Pulse

### M

MMSI Maritime Mobile Service Identity

MOB Man Over Board

MP Medium Pulse

### N

Navionics Electronic navigational chart supplier headquartered in Italy.

new pec Electronic Reference Charts issued by Japan Hydrographic Association.

NM 1NM=1852m

NMEA National Marine Electronics Association

NSK	North Stabilization Kit
N-UP	North up The north is always pointed to the top center of the radar display.
<b>O</b>	
Own track	Display function of own ship's track
Open Array Antenna	An antenna consisting of arrayed antenna elements, covered with a radome, and rotating itself.
<b>P</b>	
PI	Parallel Index line
Past positions	Equally time-spaced past position marks of a tracked or AIS target and own ship.
POSN	Position
PRF	Pulse Repetition Frequency The number of radar pulses transmitted each second.
PROC	Process Radar signal processing function
<b>R</b>	
Radar	Acronym for RAdio Detection And Ranging
Radar beacon	A navigation aid which responds to the radar transmission by generating a radar signal to identify its position and identity
Radar cross-section	Radar cross-section of a target determines the power density returned to the radar for a particular power density incident on the target
Range Rings	A set of concentric circles labeled by distance from CCRP.
Reference target	A symbol indicating that the associated tracked stationary target is used as a speed reference for the ground stabilization
Relative course	The direction of motion of a target relative to own ship motion
Relative speed	The speed of a target relative to own ship's speed data
Relative vector	A predicted movement of a target relative to own ship's motion
RM	Relative Motion A display on which the position of own ship remains fixed, and all targets move relative to own ship.
RM(R)	Relative Motion. Relative Trails.
RM(T)	Relative Motion. True Trails.
ROT	Rate of Turn Change of heading per time unit.
Route	A set of waypoints.
RR	Range Rings
<b>S</b>	
SART	Search And Rescue Transponder Radar transponder capable of operating in the 9GHz band
SBAS	Satellite-Based Augmentation System Generic technique for correcting the error of the GPS using the geostationary satellite This is used for the positioning accuracy of GPS higher.
Sea stabilization	A display mode in which speed and course information are referred to the sea.

## GLOSSARY

---

Sea state	Status of the sea condition due to the weather environment, expressed as a sea state 0 for flat conditions with minimal wind, to sea state 8 for very rough sea conditions.
SET	The current direction for manual correction or the current speed on the horizontal axis of the 2-axis log is displayed.
Sleeping AIS target	A target indicating the presence and orientation of a vessel equipped with AIS in a certain location.
sm	Statute mile 1sm=1609.344m
SOG	Speed Over the Ground The speed of the ship relative to the earth, measured on board of the ship.
SP	Short Pulse
STAB	Stabilization
STC	Sensitivity Time Control Function of STC reduces the impact of returns from sea state of relatively near from own ship.
STW	Speed Through Water The speed of the ship relative to the water surface.

### T

TCPA	Time to Closest Point of Approach to own ship
Test target	Radar target of known characteristics used for test requirement.
TM	True Motion A display across which own ship moves with its own true motion.
Trails	Display Radar Trails (Other Ships' Trails).
True course	The direction of motion relative to ground or to sea, of a target expressed as an angular displacement from north.
True speed	The speed of a target relative to ground, or to sea.
True vector	A vector representing the predicted true motion of a target, showing course and speed with reference to the ground or sea.
TT	Target Tracking A computer process of observing the sequential changes in the position of a radar target in order to establish its motion. Such a target is a Tracked Target.
TTG	Time To Go Time to next waypoint.
TXRX	Transceiver Unit

### U

USB	Universal Serial Bus USB was designed to standardize the connection of computer peripherals.
UTC	Universal Time Coordinated The international standard of time, kept by atomic clocks around the world.

### V

VRM	Variable Range Marker An adjustable range ring used to measure the distance to a target.
-----	---

### W

Waypoint	A geographical location on a route indicating an event.
----------	---



# Chapter 1 INSTALLATION

## 1.1 OVERVIEW

The proper installation of the radar equipment is critical in ensuring its effective and reliable performance as well as facilitating maintenance and repair. Carefully install the radar equipment by following the procedures below.

- Considering the weight of the scanner unit and install it in a high place as possible.
- It is preferable to install the display unit in the wheel house to facilitate observations.
- Available cable lengths and types for installing the radar JMA-3400 are as shown in the table below. Request an appropriate cable from JRC beforehand.

A cable longer than the sufficient length may degrade radar performance, so give it careful consideration when planning the installation.

All installation cable is option.

Installation Cable	CFQ-6912-5	5m
(Option)	CFQ-6912-10	10m
	CFQ-6912-15	15m
	CFQ-6912-20	20m
	CFQ-6012-30	30m



**Power Supply Cable**  
**Type Name: CFQ-7758**  
**Length: 3m**  
**Standard Supply**

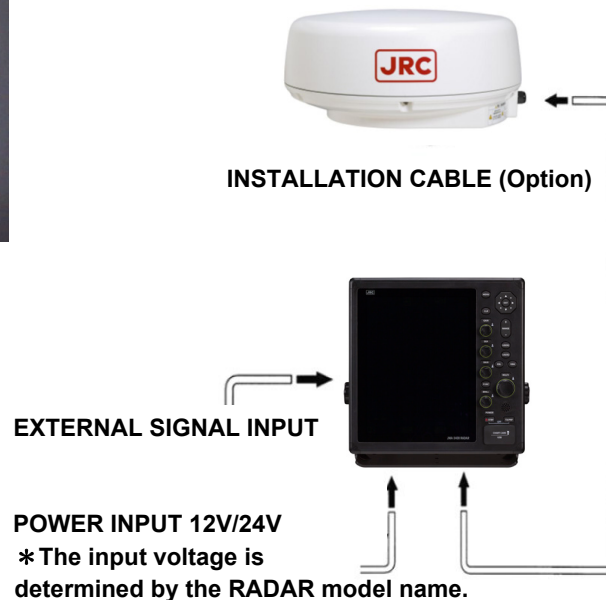

Connect the arrows in the diagram.

(For inputting external signal, optional NMEA cable is required. Refer to chapter 1.2.6.)

## 1.2 INSTALLATION OF THE DISPLAY UNIT

### 1.2.1 SELECTING THE INSTALLATION POSITION

Select the display unit installation position by taking into consideration of the followings.

- Install the display unit so that the user can easily conduct observations.
- To reduce affect on the magnetic compass, install the display unit more than 1 meter away from the compass.
- Take precautions to prevent water from splashing through the window or door of the bridge onto the display unit.
- Install the display unit by considering convenience of maintenance.
- Install the display unit so that when the user is looking ahead, the lookout view is not obscured.
- Install the unit away from direct sunlight and heat source.

### 1.2.2 SELECTION OF DISPLAY MOUNTING

Display is designed to various mounting way for users circumstance.

Mounting way.

- Desktop Installation
- Flush Mounting

Note: JMA-3400 series are not supported to ceiling Installation.

### 1.2.3 DIMENSIONAL DRAWING OF DISPLAY MOUNTING

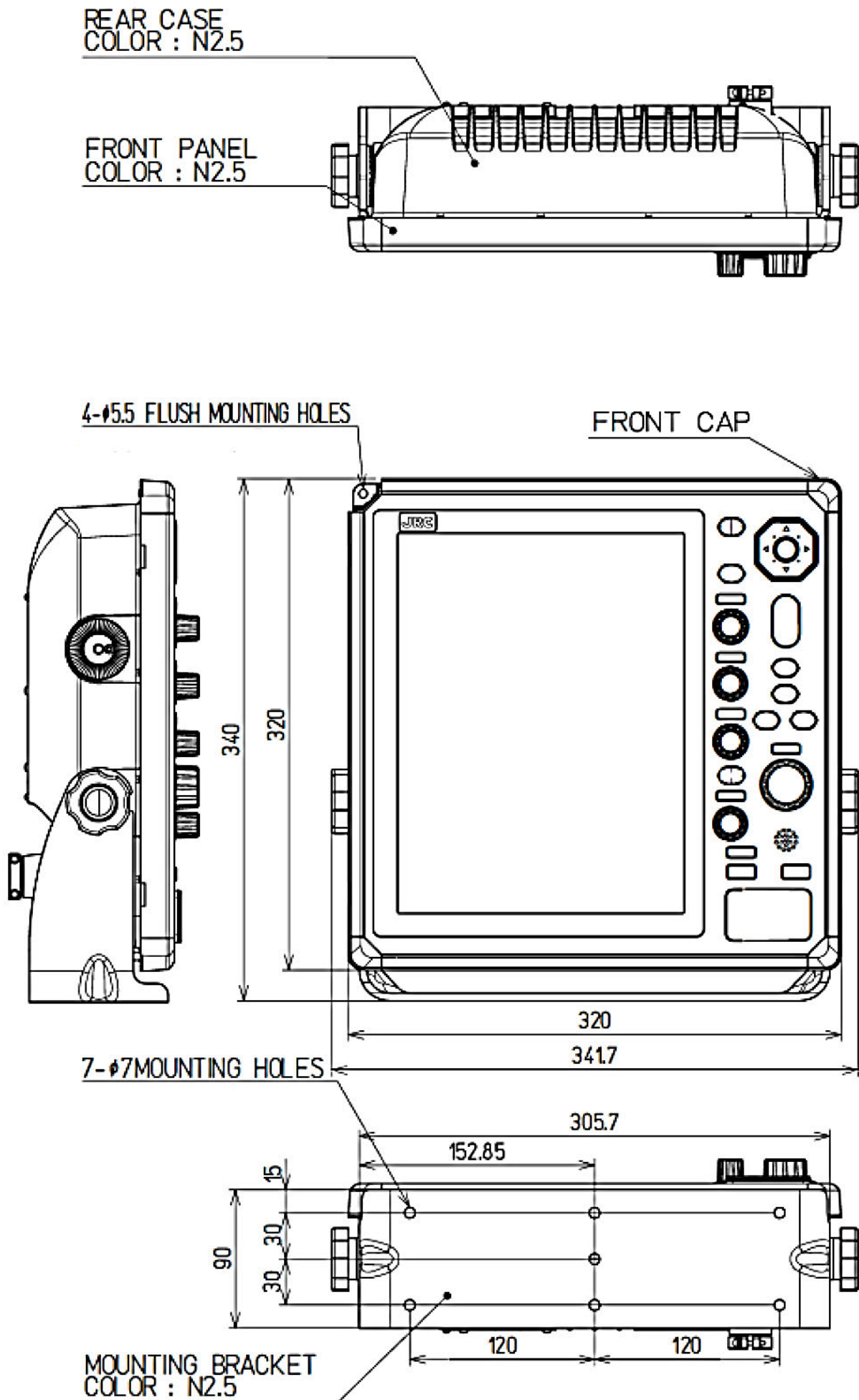

OUTLINE DIMENSIONS		PERMISSIBLE OUTLINE DIMENSIONAL DEVIATIONS	PERMISSIBLE MOUNTING DIMENSIONAL DEVIATIONS
OVER	TO		
3	6	±0.5	±0.5
6	30	±1	
30	120	±1.5	
120	400	±2.5	±1
400	1000	±4	±2

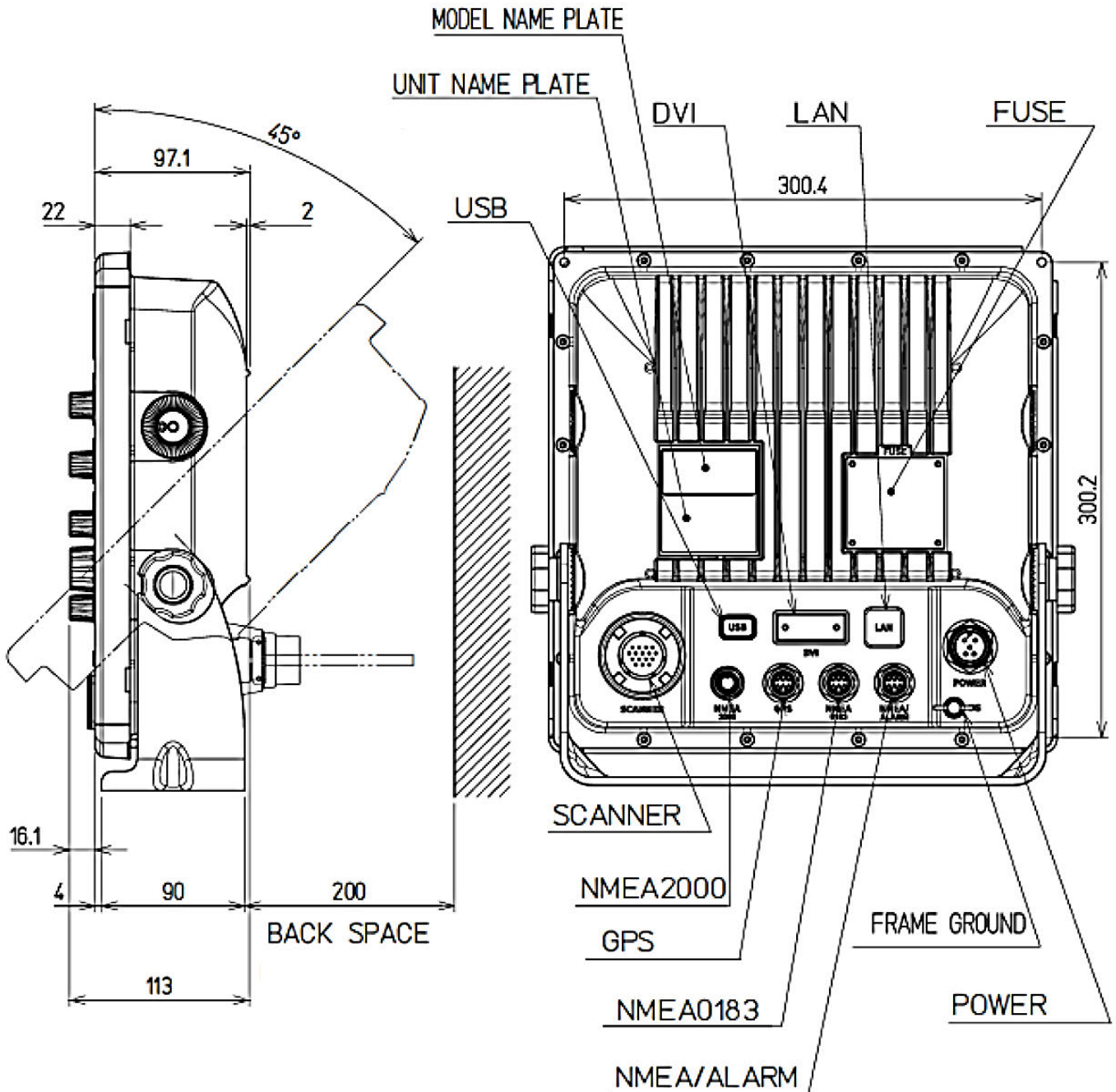

## 1.2.4 EXAMPLES OF DISPLAY MOUNTING

### ■ DESK TOP INSTALLATION

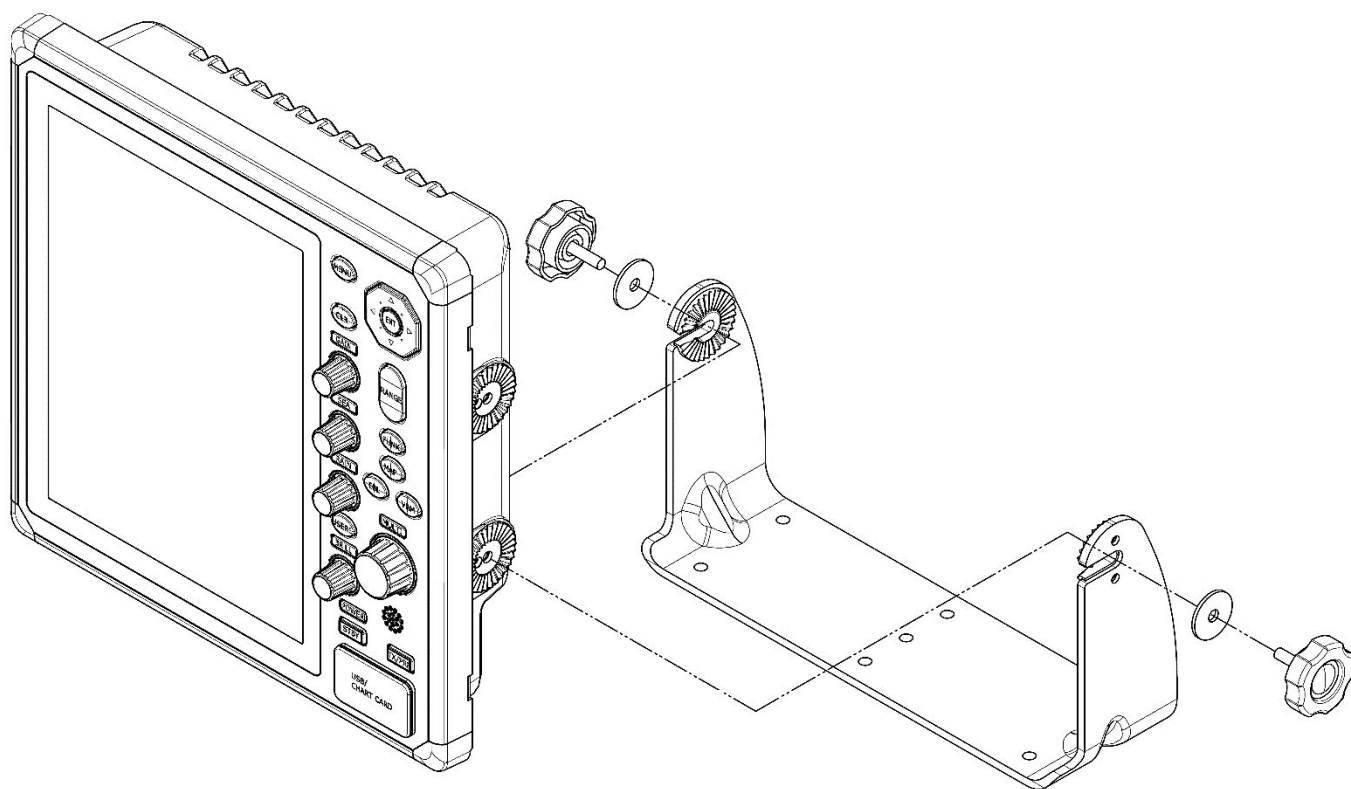

## ■ DESKTOP MOUNTING TEMPLATE

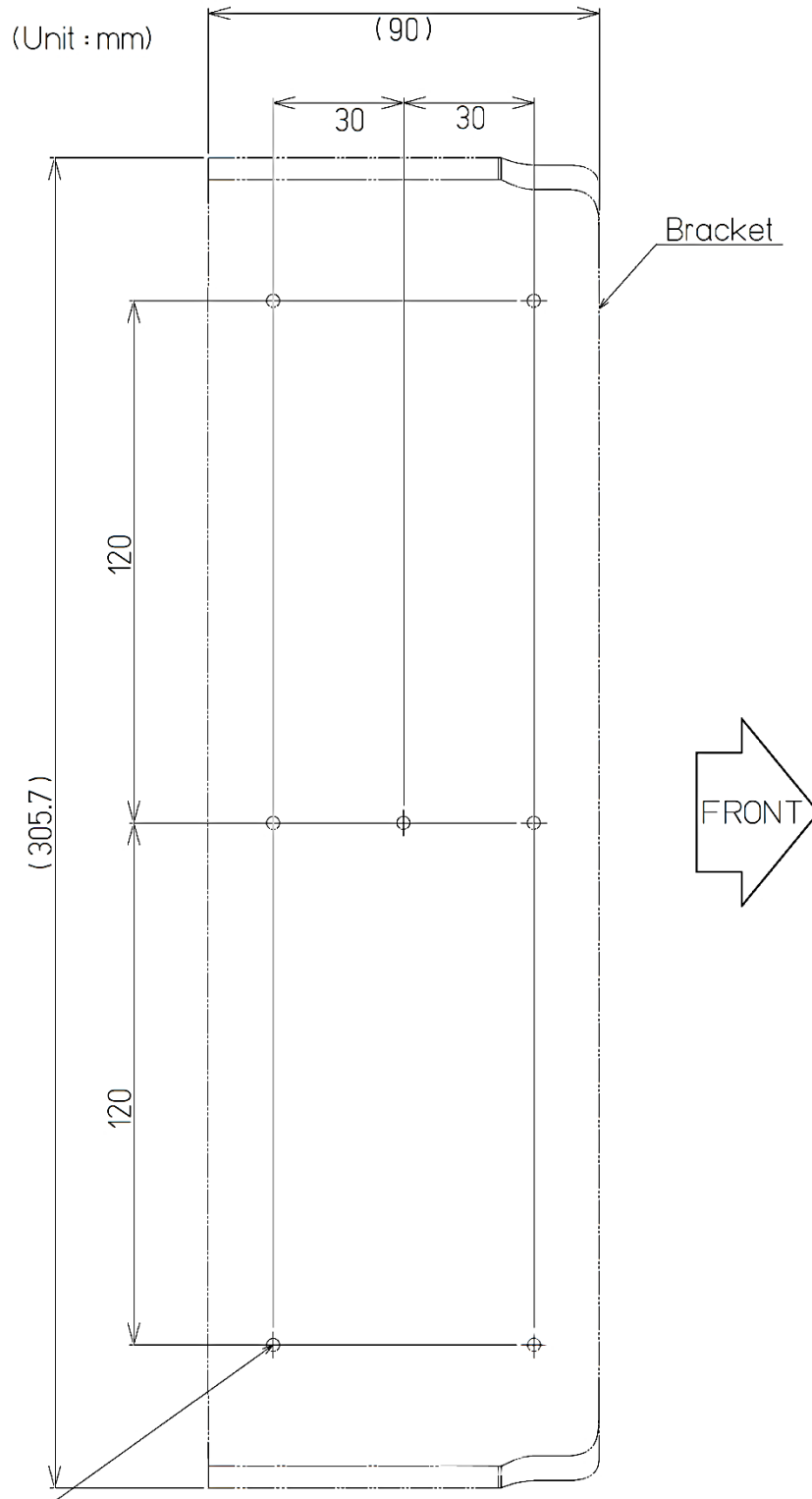

7-Prepared hole  
for tapping screw  
(Size 6x25(L))

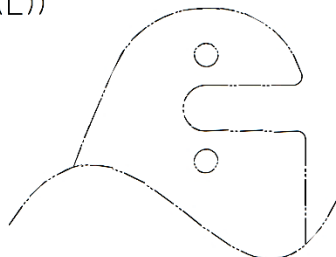

**Note: Please note the paper size.**

## ■ FLUSH MOUNTING

Remove base, and take out cover of front panel. Please slide out, when removing of the front caps.  
And refer to how to slide out of the front caps below as.

/// How to slide out of the front cap ///

The back of the front cap has two flat ends as below figure.  
Using two index fingers, push up on these two flat sides at the same time. At this time, support the front panel with both thumbs as shown in the right figure, but be careful not support by your thumb on the front cap.

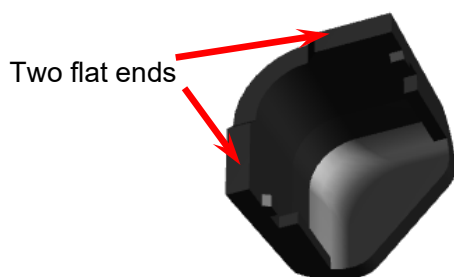

The back of the front cap



How to slide out of the front cap

Fix with the front 4 corner screws to the wall.

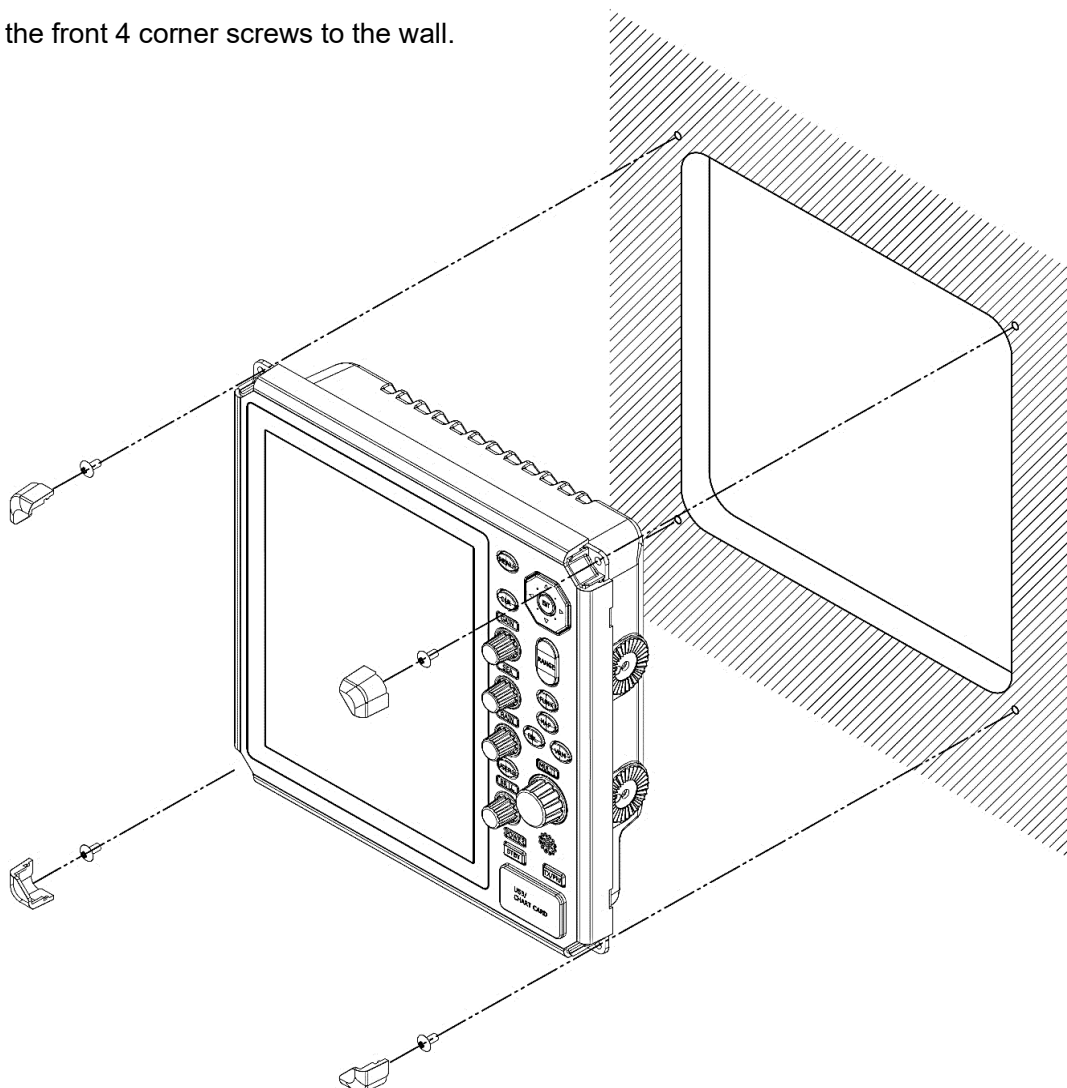

## ■ FLUSH MOUNTING TEMPLATE

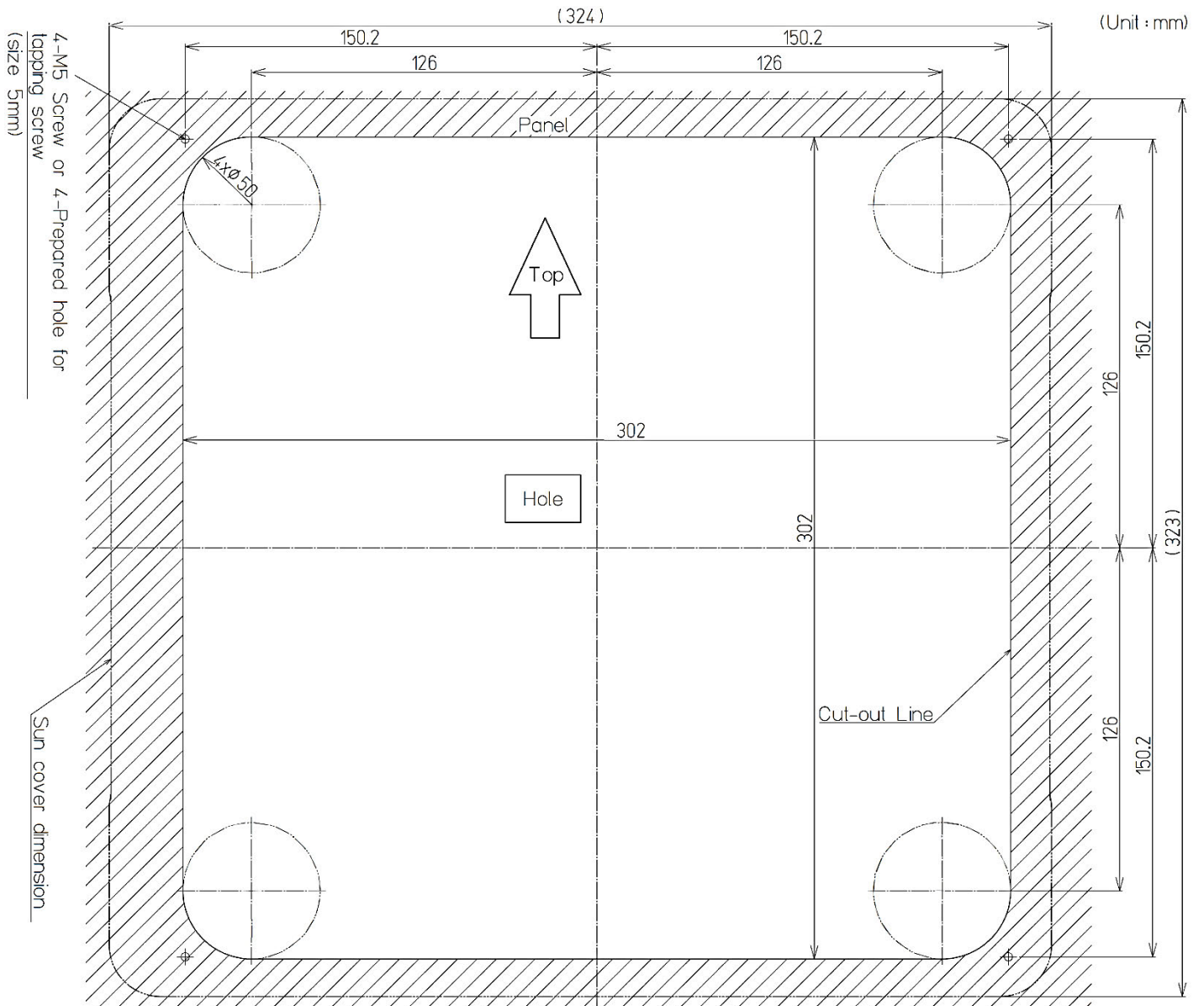

**Note: Please note the paper size.**



## 1.2.5 POWER CABLE INSTALLATION

This equipment includes a 3m power cable for power supply to the display unit.

Cable assembly name: CFQ-7758

The cable core wire color is red/white (+), black/green (-) and shield mesh (frame ground).

Wire :            AWG12  
 Red/White:    +12/24V  
 Black/Green:  0V  
 Shield:         FG (frame ground)



Note: Use a rectifier if necessary.

CFQ-7758

### CAUTION



**When you connect with the ship power supply without using the optional rectifier, you need measure the voltage between the ground and the positive / negative side of the ship power supply.**

**When the ship power supply is more than 38V, please take through measures such as attaching a rectifier.**

**If you connect to the ship power supply directly without taking any measures, there is a risk of system failure or accident occur.**

#### ■ Power Cable Installation

Connect the power cable (CFQ-7758) to the power input connector of display unit. At that time, please turn to the right the tip locking mechanism to lock the position of the connector.

## 1.2.6 EXTERNAL NAVIGATIONAL SIGNAL CONNECTION

(GPS, AIS, GYRO, LOG, etc.) Connecting cable is option

Option NMEA cable: "CFQ-9002 (GPS)", "CFQ-5374 (NMEA0183)"

In case of using option NMEA cable, waterproofing (IPX5) is guaranteed. Thus, using another NMEA cable, waterproofing (IPX5) is not guaranteed.

- Using JRC GPS receiver, please connect NMEA4 (GPS port).
- AIS connects all NMEA port available.

Navigation system interfaces, such as GPS

Telecommunications standard NMEA0183 / IEC61162-1/2 conformity

Communications protocol: 4800 bps, start 1bit, data 8bit, stop 1bit, and no parity

Input sentence NMEA0183: V1.5: GGA/ GLL/ RMC

V2.0: GGA/ GLL/ RMC/ ZDA

V2.3: GGA/ GLL/ RMC/ GNS/ ZDA

(Talker= "G P" etc.)

Information ship position and the time; GGA/ GNS/ GLL/ RMC

Day ZDA

Time of equipment: ZDA/ GGA/ GNS/ GLL/ RMC

Reference :

### NMEA0183 content outline of standard input / output sentence

<b>\$xxACK</b>	<b>Acknowledgement alarm</b>
<b>\$xxBWC</b>	<b>Bearing and Distance to Waypoint</b>
<b>\$xxCUR</b>	<b>Water current layer</b>
<b>\$xxGGA</b>	<b>Global Positioning System Fix Data</b>
<b>\$xxGLL</b>	<b>Geographic Position - Latitude/Longitude</b>
<b>\$xxGNS</b>	<b>GNSS fix data</b>
<b>\$xxMTW</b>	<b>Water temperature</b>
<b>\$xxMWD</b>	<b>Wind direction and speed</b>
<b>\$xxMWV</b>	<b>Wind speed and angle</b>
<b>\$xxRMA</b>	<b>Recommended Minimum Specific LORAN-C data</b>
<b>\$xxRMB</b>	<b>Recommended Minimum Navigation Information</b>
<b>\$xxRMC</b>	<b>Recommended Minimum Specific GNSS Data</b>
<b>\$xxROT</b>	<b>Rate Of Turn</b>
<b>\$xxRSA</b>	<b>Rudder Sensor Angle</b>
<b>\$xxTHS</b>	<b>True Heading and Status</b>
<b>\$xxVBW</b>	<b>Dual ground/water speed</b>
<b>\$xxVDM</b>	<b>AIS VHF Data-link Message</b>
<b>\$xxVDO</b>	<b>AIS VHF Data-link Own-vessel report</b>
<b>\$xxVTG</b>	<b>Course Over Ground and Ground Speed</b>
<b>\$xxZDA</b>	<b>Time and Date</b>

JMA-3400 series is partly compatible with NMEA2000. Not fully NMEA2000 compliant , and not also fully IEC61162-3. Thus, we are describing “CAN” in this manual.

To use CAN, an optional or commercial CAN cable is required.

The model name of the CAN option cable is “CFQ-7765.”

For information about CAN PGN that can be used for input/output, see "13.7 INPUT/OUTPUT SIGNAL."

## 1.3 INSTALLATION OF THE SCANNER UNIT

### 1.3.1 SELECTING THE INSTALLATION POSITION

#### ■ PHYSICAL SELECTION CRITERIA

- Install the scanner at the center of the mast on the keel line.
- If the scanner cannot be installed at the above position for some reason, the amount of deviation must be minimized. And, reinforce the mount base and the platform and take precautions to protect the scanner from vibration and impact at the installation position.
- To avoid the radiating section coming in contact with other installed objects while it is rotating, ensure that there is at least 200 millimeters from the swing circle (turning radius) to other installed objects (Fig. 1-3-1-1). The swing circle of the JMA-3400 radar's scanner is as shown in Table 1-3-1-2.
- Please note that not affected by the smoke from the chimney.
- Avoid having a rope or signal flag from winding around the radiating section thereby preventing it from rotating.
- Please secure maintenance spaces (a platform, a safety link, a handrail, a step, etc.).

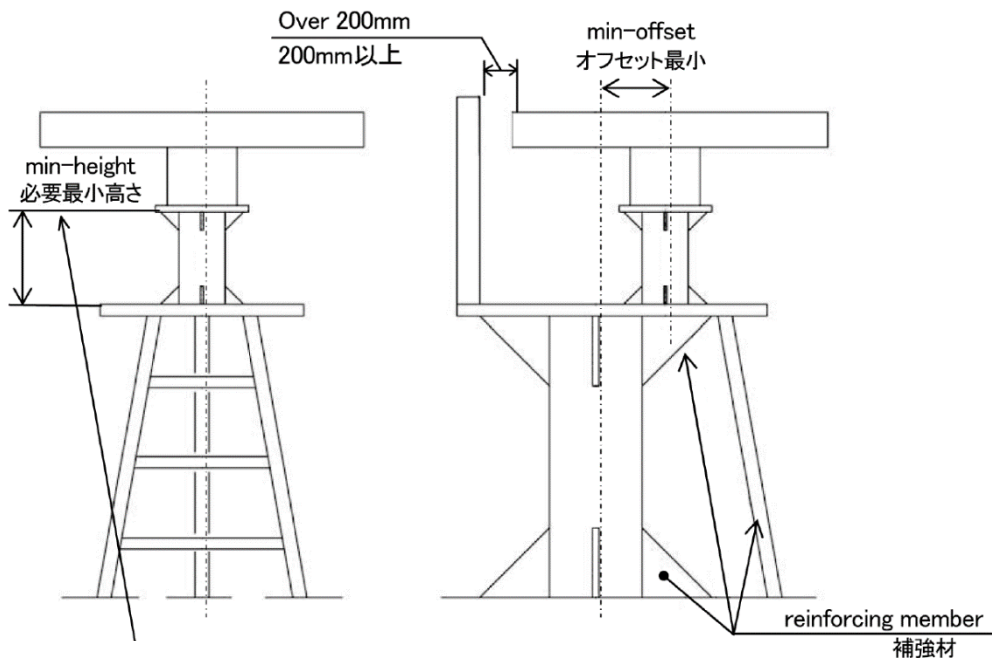

Set up a scaffolding for maintenance if the minimum height shown above is 1 m or more.

Fig. 1-3-1-1

Table1-3-1-2

Scanner model (length)	Swing circle
NKE-2043	620 mm (radome)
NKE-2063A/AHS (3.9 feet)	1,220 mm
NKE-2103-4/4HS (4 feet)	1,320 mm
NKE-2103-6/6HS (6 feet)	1,910 mm

## ■ ELECTRICAL SELECTION CRITERIA

- The installation height of the scanner relates to the maximum detection distance. The higher, the better. However, if it is too high, radio wave energy greatly attenuates above the scanner's vertical beam width (the point -3 dB from the peak of the main-lobe). As a result, it is difficult to detect a close-in target. Sea clutter also increases. Determine the installation height by taking into consideration the weight, maximum length of the cable, and maintenance after installation. If the installation height of the scanner is low, it is difficult to detect a long distance target. The ship's mast, derrick, and chimney interfere with radiating beam causing the range that cannot be viewed on the radar display to increase.

### 1.3.2 LOWEST SCANNER INSTALLATION HEIGHT

Generally, the lowest scanner installation position is supposed to be on the A-B line shown in Fig. 1-3-2. In the case of the JMA-3400 series radar,  $2\theta$  equals  $20^\circ$ .

Specifically, the scanner position is normally elevated so that the chimney and the shrine-gate type mast do not interfere with radiating beam.

**JMA-3400 :  $\theta = 10^\circ$  ( $2\theta = 20^\circ$ )**

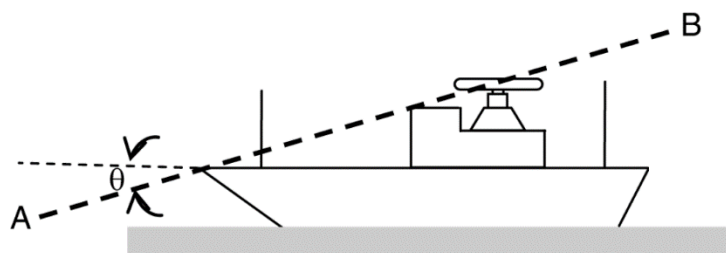

Fig. 1-3-2

### 1.3.3 MOUNTING RACK AND MAST FOR THE SCANNER

If it is considered that sufficient installation height cannot be provided when the scanner is installed directly on the roof of the wheelhouse, use a mounting rack or radar mast (Fig. 1-3-3).

Normally, when the scanner installation height is less than 2 meters from the roof of the wheelhouse, provide a mounting rack assembled at an angle frame to install the scanner. When the scanner installation height is 2 m or higher from the roof of the wheelhouse, provide a cylindrical radar mast to install the scanner.

Consider the convenience of the service staff who take care of installation, maintenance, adjustment and repair of the scanner by providing adequate footholds to the mounting rack and the radar mast.

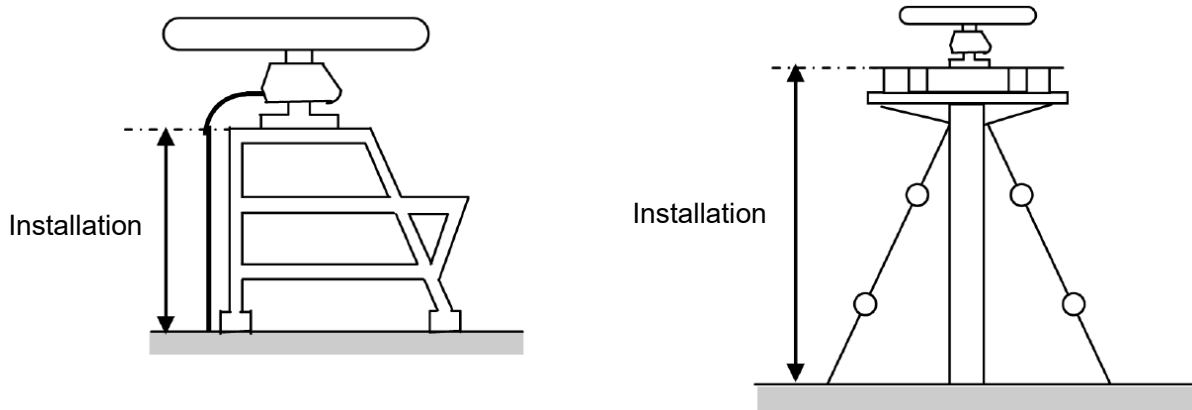

Fig. 1-3-3

### 1.3.4 SCANNER AND THE SURROUNDING STRUCTURAL OBJECTS

When installing the scanner, select a location where there are the fewest structural objects in the surrounding area so that false images which interfere with target detection will not be generated by signal reflection from other scanners, deck structures, and cargo.

Only as a guide, note that structural objects should not exist within the range of the vertical beam width (Fig. 1-3-4).

NKE-2043	Vertical beam width: Approx.25°	(+/-12.5° when the height of the radiating section is 0°)
NKE-2063A/AHS	Vertical beam width: Approx.30°	(+/-15.0° when the height of the radiating section is 0°)
NKE-2103-4/4HS	Vertical beam width: Approx.20°	(+/-10.0° when the height of the radiating section is 0°)
NKE-2103-6/6HS	Vertical beam width: Approx.20°	(+/-10.0° when the height of the radiating section is 0°)

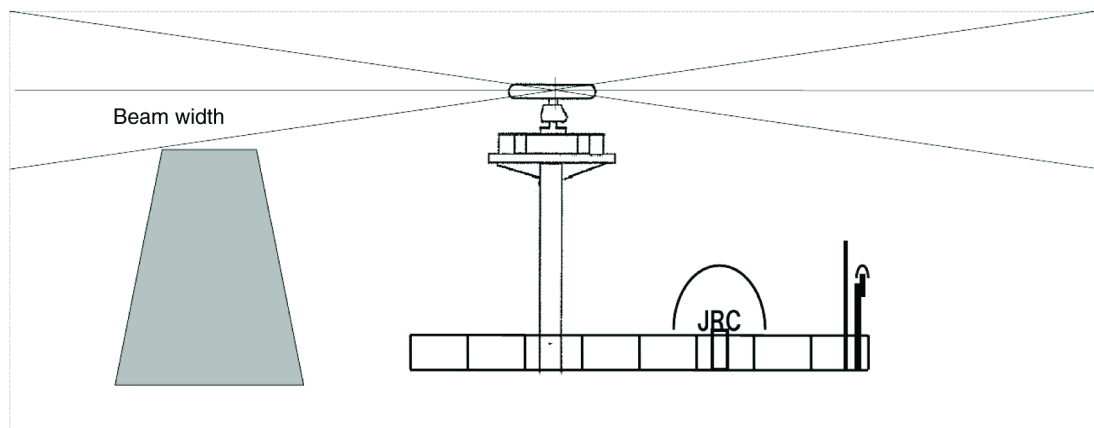

Fig. 1-3-4

When installing two scanners, provide a height difference so that those two scanners do not enter each

other's vertical beam width range.

To avoid interference with other equipment and to prevent radio noise from generating, do not place the VHF antenna, GPS antenna, and INMARSAT's dome within the range of the vertical beam width. Keep a record of installation height data. The data is necessary for the initial setting of the display unit.

Magnetron which has strong magnetic force is included in the scanner. Install the scanner at least 3 meters away from nautical instruments including magnetic compasses and chronometers.

### 1.3.5 ENSURING VIEW ANGLE

Minimize the blind sector, and ensure the adequate view angle so that the blind sector does not exist in the range  $22.5^\circ$  from side to rear (Fig. 1-3-5).

Specifically, ensure a sufficient view field in the straight front (relative bearing  $0^\circ$ ).

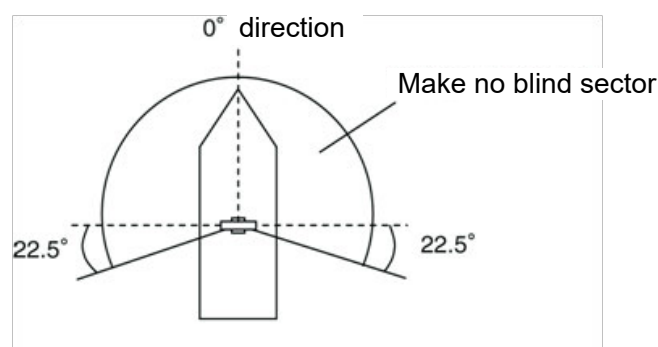

Fig. 1-3-5

#### Reference:

- If there is a concern that structural objects existing within the vertical beam width may generate false images, equip the structural objects with a radio wave absorber. (There are two types of absorbers: broadband type having no specific resonant frequency and narrowband type which can absorb a band with a specific frequency. Use those where applicable.)  
Furthermore, it is effective to install a metal reflector, which reflects radio waves upwardly, between the scanner and a structural object so that the radar's radio wave will not directly come in contact with the structural object.
- Because most radio wave absorbers have poor durability, some must be replaced every year.  
When installing a reflector, the area to the rear of the reflector becomes a blind sector. Therefore, minimize the size of the reflector.
- The above procedures for selecting a scanner installation position are described based on the radar's scanner. Comprehensively select the scanner position by considering other scanners' installation procedure manual, hull's structure, strength of the selected position, and vibration.

#### ■ Confirmation during test run

If the scanner vibrates a lot during test run, try to reduce or prevent vibration by reinforcing the scanner mount base or using wire stays attached to the radar mast.

■ **Others**

The design of the mounting platform for the scanner should take into account the vibration requirements defined by IEC 60945.

■ **Vibration**

Frequency	2 to 13.2 Hz 13.2 Hz to 100 Hz
Amplitude	+/-1 mm +/-10 %
Acceleration	7m/s <sup>2</sup> constant

- All installations should facilitate protection of equipment, including cabling, from damage.
- The cables should be kept as short as possible to minimize attenuation of the signal.
- Crossing of cables should be done at right angles(90°) to minimize magnetic field coupling.
- Install the radar cable as far as from the cables of other radio equipment in order to prevent other radio equipment from interfering with the radar operations. Especially inter-wiring cables between scanner unit and display unit of the radar should not be run parallel with the cables of other radio equipment.
- Cable should not be exposed sharp bends.
- Ensure that the equipment is grounded.

■ **Maintain a flat level surface on which to install the scanner**

- Use sufficiently thick steel material and reinforcement material for the scanner's installation surface (mount base) to reduce vibration and impact. Keep the mount base flat and smooth.
- If there is a partial gap between the mount base and the scanner chassis's legs, work on the installation surface so that it becomes flat and smooth, or make adjustments by inserting metal shims.  
If a gap exists and the scanner is tightly clamped, the chassis will distort and become damaged by vibration.

■ **Avoid using vibration-proof rubber and resin**

- Do not insert an elastic body, such as vibration-proof rubber or resin, between the mount base and the scanner chassis legs. If rubber or resin is inserted, the amplitude of vibration increases, resulting in the possibility of damage to the scanner. Furthermore, if installation bolts become loose due to deterioration of rubber or resin, the scanner may be damaged or fall from its mount.



**1.3.6 CONFIRM MOUNTING BASE BEFORE INSTALL**

**NKE-2043 2FT SCANNER**

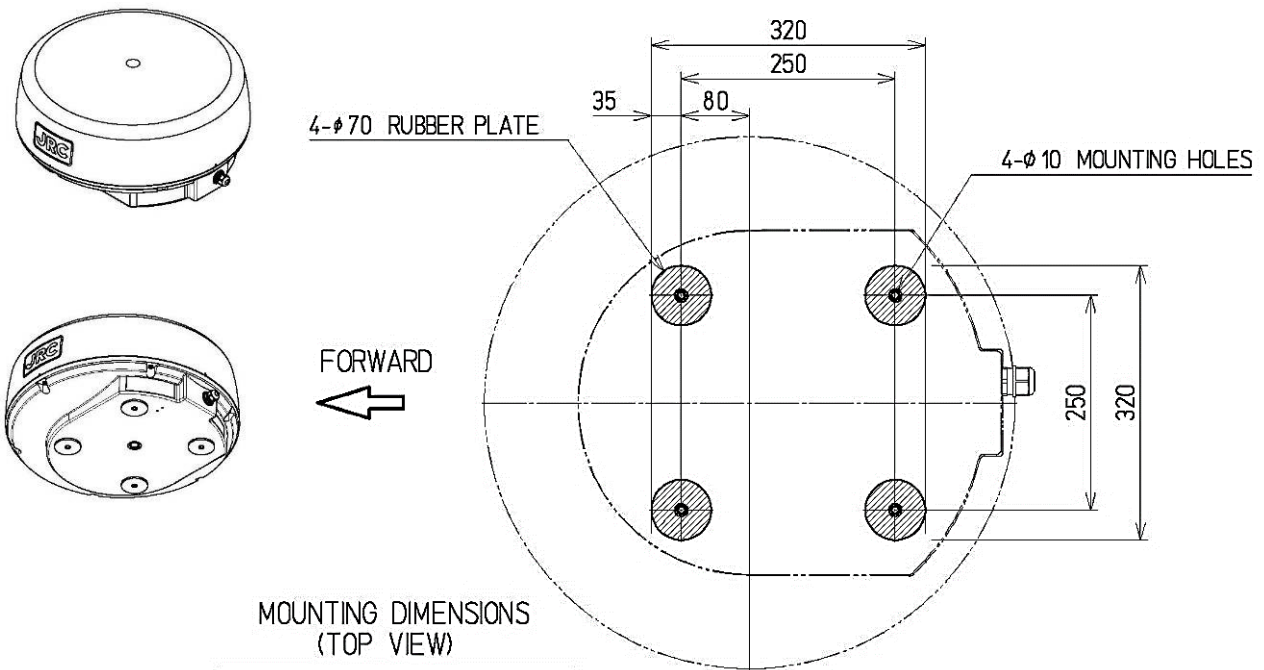

Fig 1-3-6-1

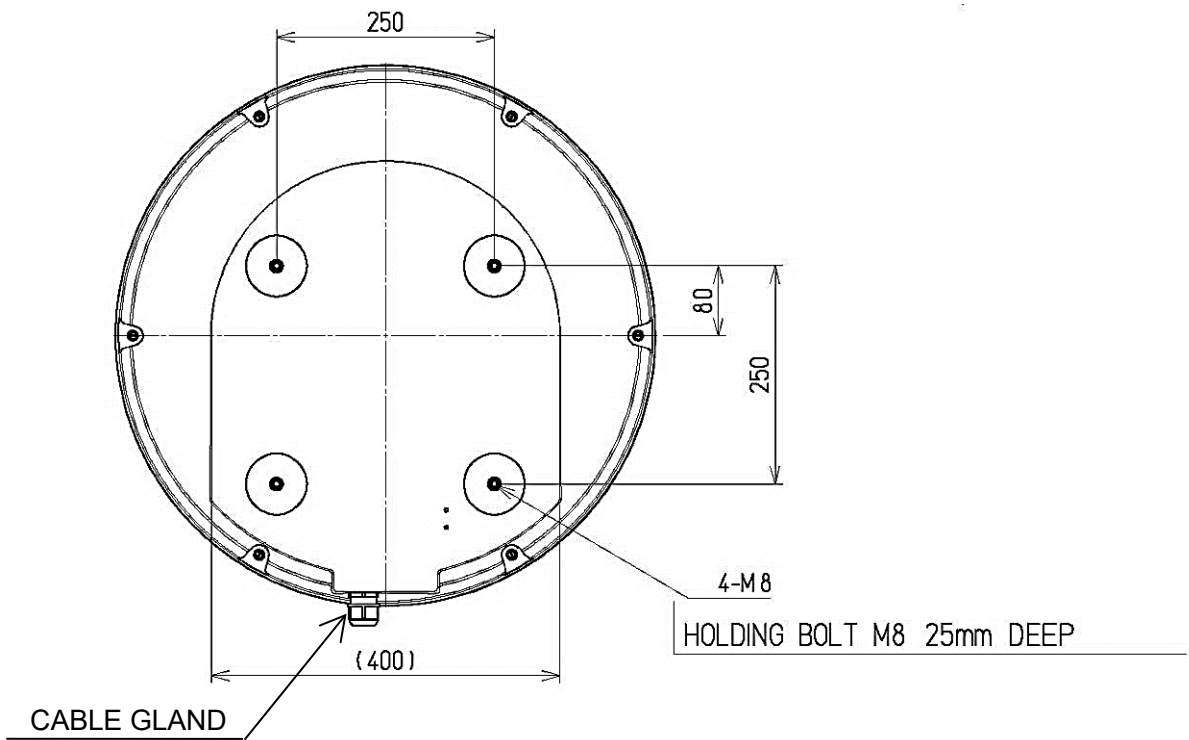

Fig 1-3-6-2

**NKE-2063A/AHS 3.9FT SCANNER**

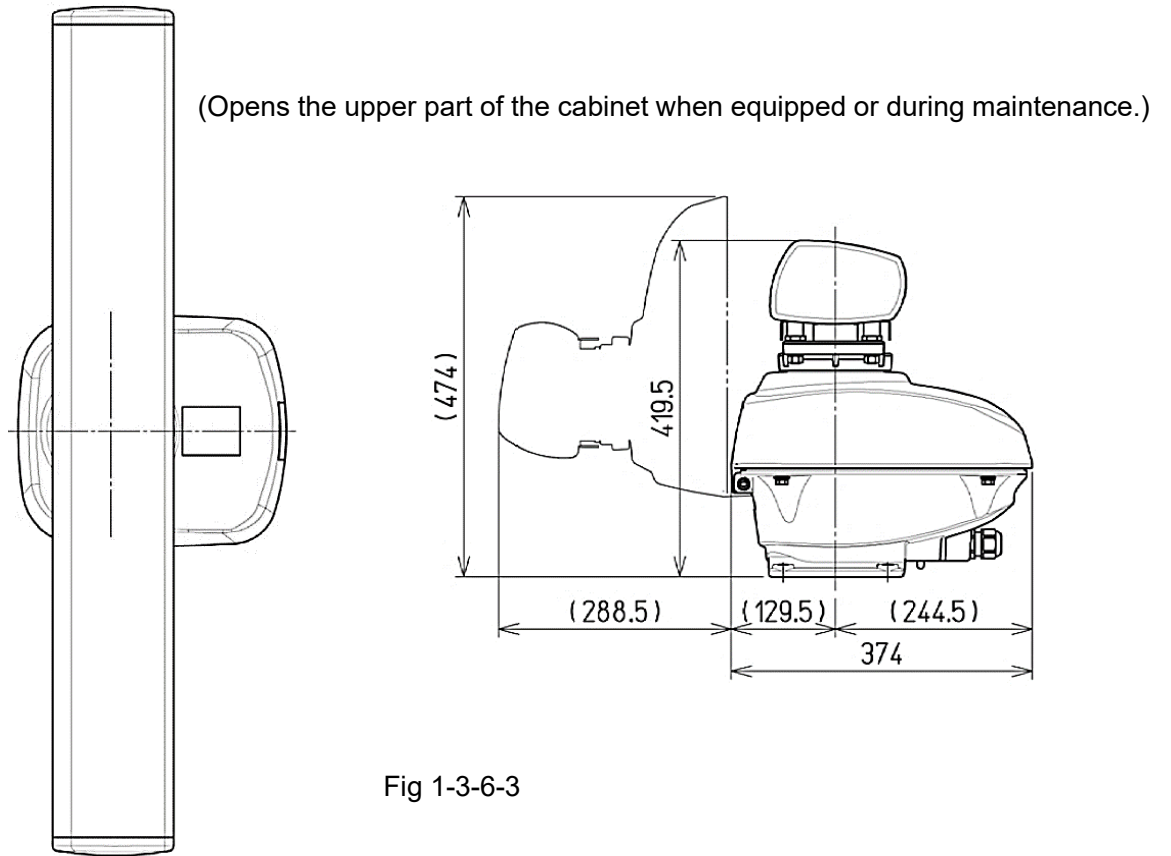

Fig 1-3-6-3

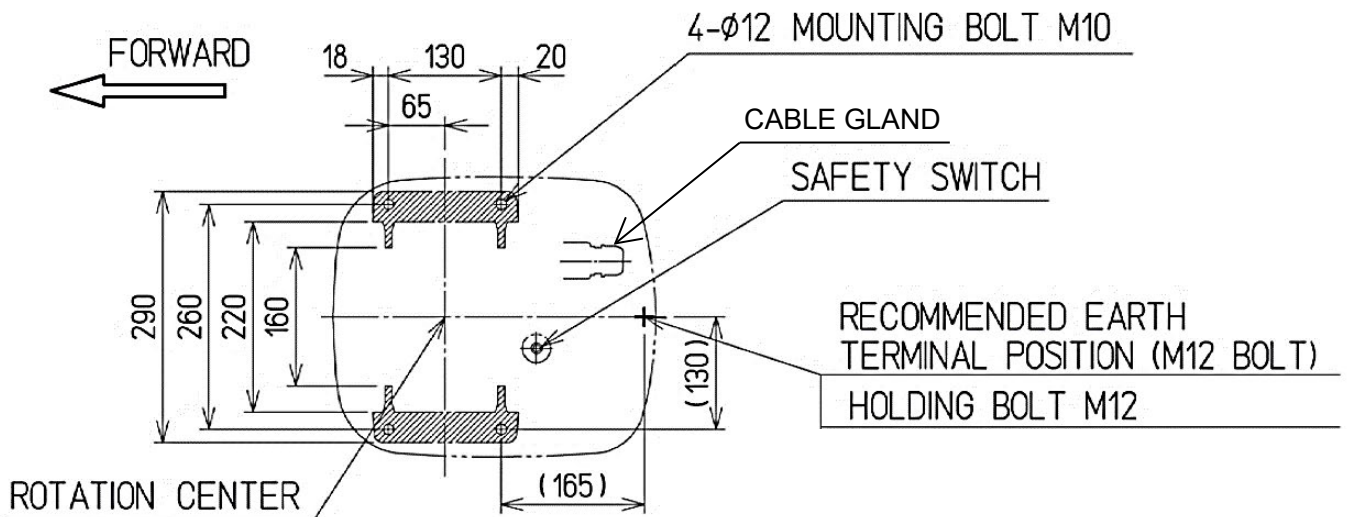

Fig 1-3-6-4

NKE-2103-4/4HS 4FT SCANNER

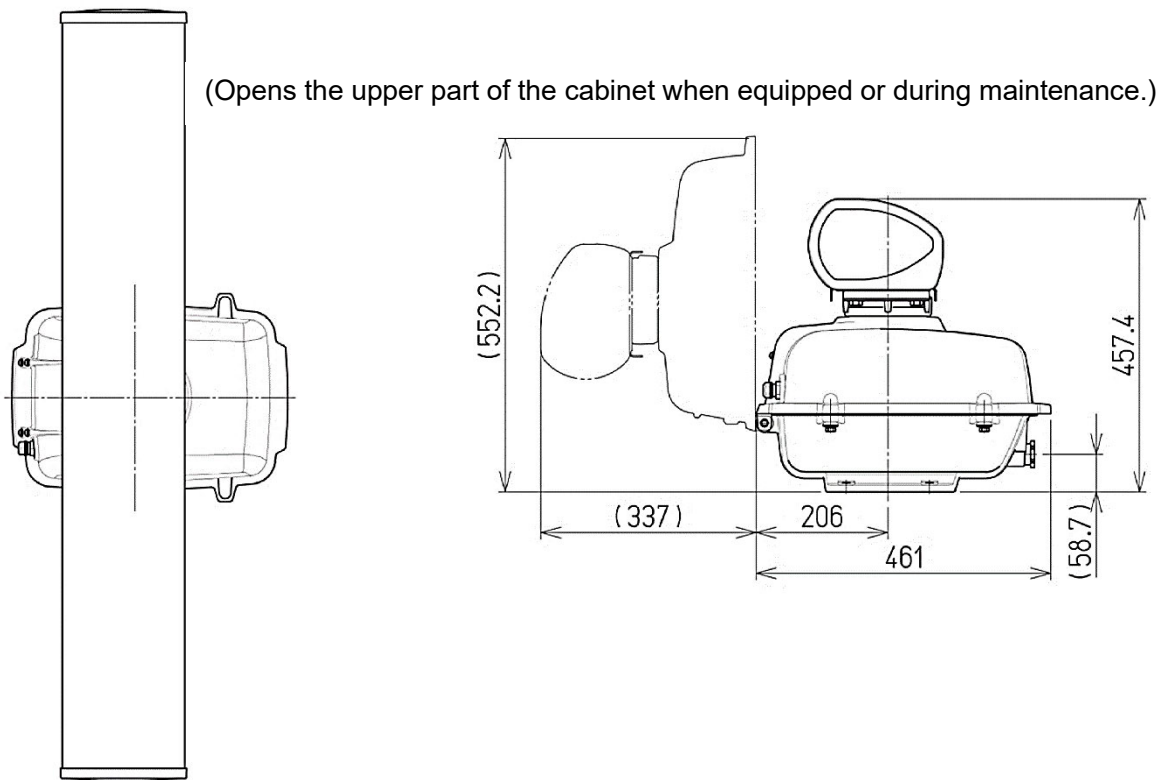

Fig 1-3-6-5

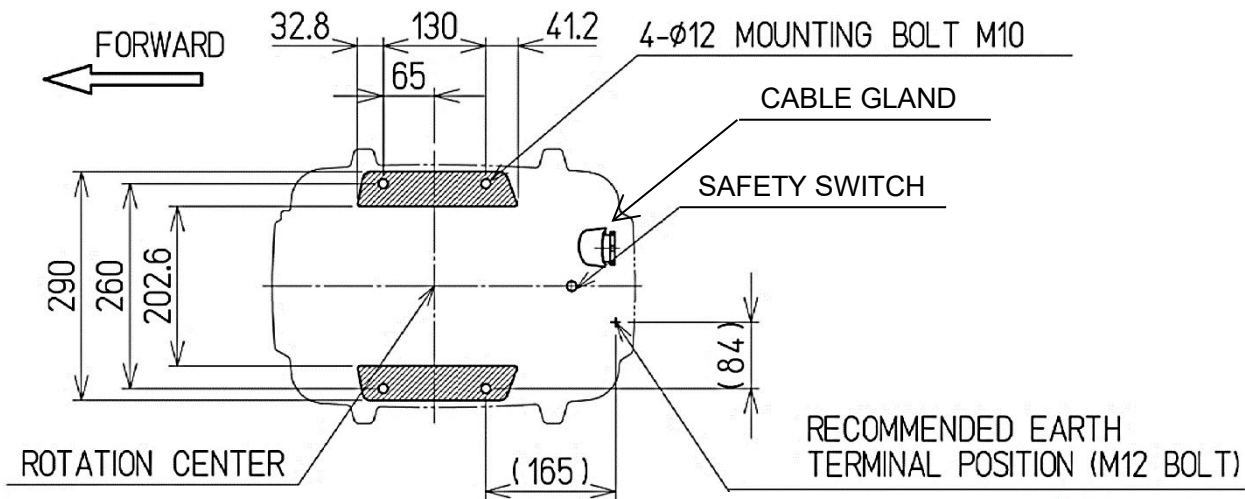
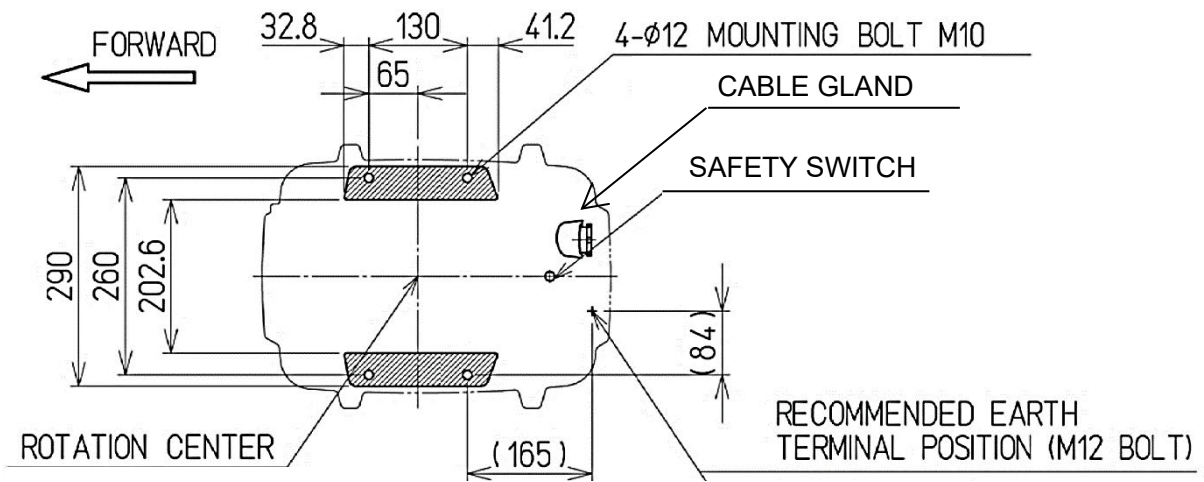
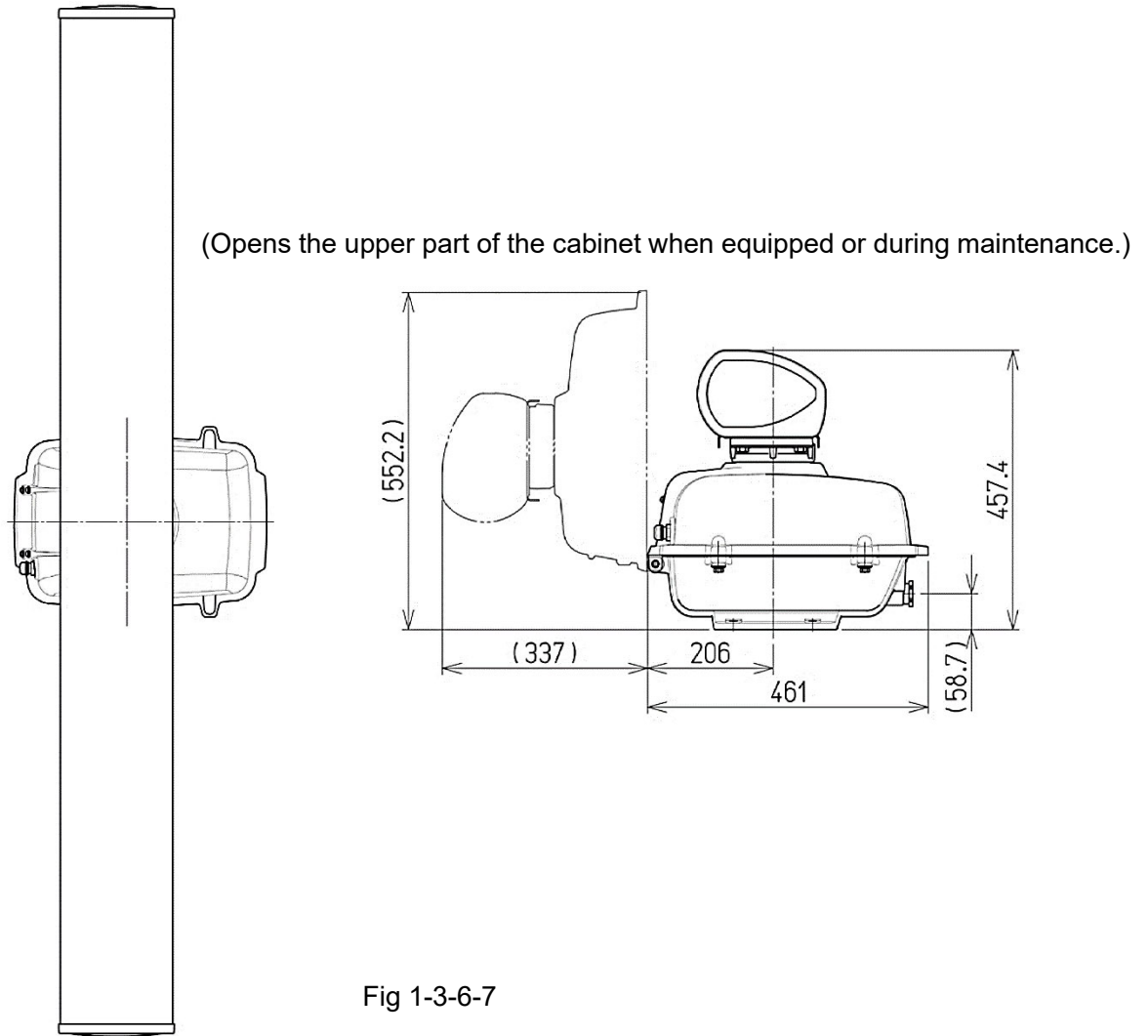

Fig 1-3-6-6

**NKE-2103-6/6HS 6FT SCANNER**



## ■ Precautions for transporting and storing the scanner

- A scanner is a heavy load. Be very careful about handling it.
- Do not allow the scanner fall on its side while it is stored or being installed.
- Do not apply rope to the scanner in the way that squeezes or deforms the radiating section.
- When hoisting the scanner by a crane, do not hoist it by attaching a belt or a rope only to the scanner's radiating section as shown in Fig1-3-6-9.
- When lifting the scanner (Fig 1-3-6-10) :  
Wrap a cloth around the scanner's support section located at the bottom of the radiator, and then attach a belt to it to lift the scanner.

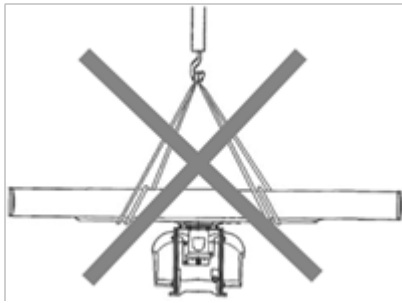

Fig 1-3-6-9

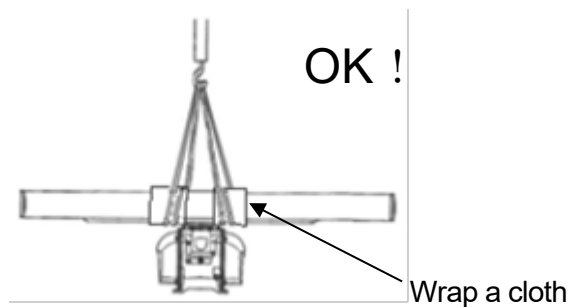

Fig 1-3-6-10

## ■ Installation and clamping method

### ■ Installation direction

Installation should be done so that the cable gland is oriented toward the stern.

### ■ Bolts, nuts and tightening torque to be used

- Use stainless steel bolts for the scanner and uniformly tighten all of the bolts using double nuts for each bolt so that the scanner will not become loose (Table 1-3-6-1).
- Although the length of the bolt will differ according to the thickness of the mount base, use a bolt long enough so that more than 4 millimeters of thread protrudes beyond the double nuts after the double nuts have been tightened.

**Table 1-3-6-1 Length of scanner mounting bolts and tightening torque**

	Thickness of Mount Base	Bolt	Torque (N-m)
X band	12	M10×55 (mm) SUS304	40

■ Use of washer and corrosion-resistant measures

- At the location where a bolt's head comes in contact with the scanner chassis' legs and the mount base, insert a plain washer and spring washer which fit the bolt; and then securely tighten the bolts. (Fig. 1-3-6-12)
- To prevent corrosion due to the contacts between different metals, such as the scanner chassis' legs, installation surface, bolts etc., cover the bolt's head with sealant . (Fig. 1-3-6-11)

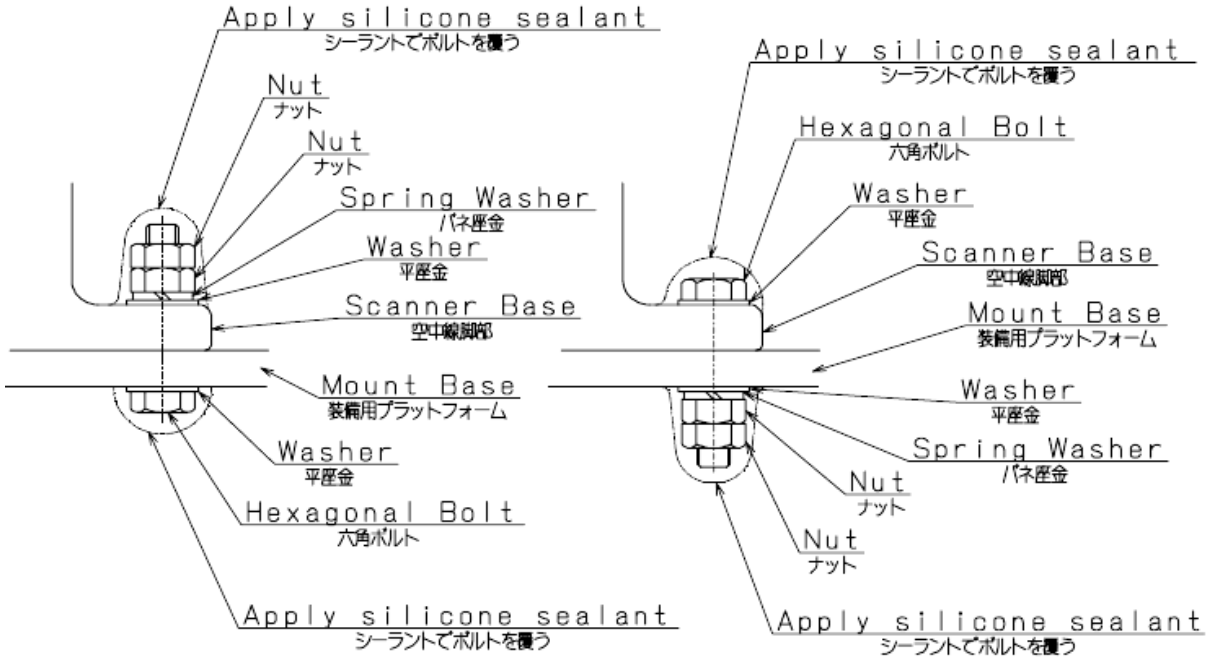

Fig 1-3-6-11

■ Grounding and corrosion-resistant measures

- Do not install the scanner in place where puddles are often formed.
- Ground the antenna housing and the equipment surface (hull) with a ground wire. At this time, apply a sealant to the fastening part of the ground wire to prevent corrosion and damage due to vibration.(Fig. 1-3-6-12)

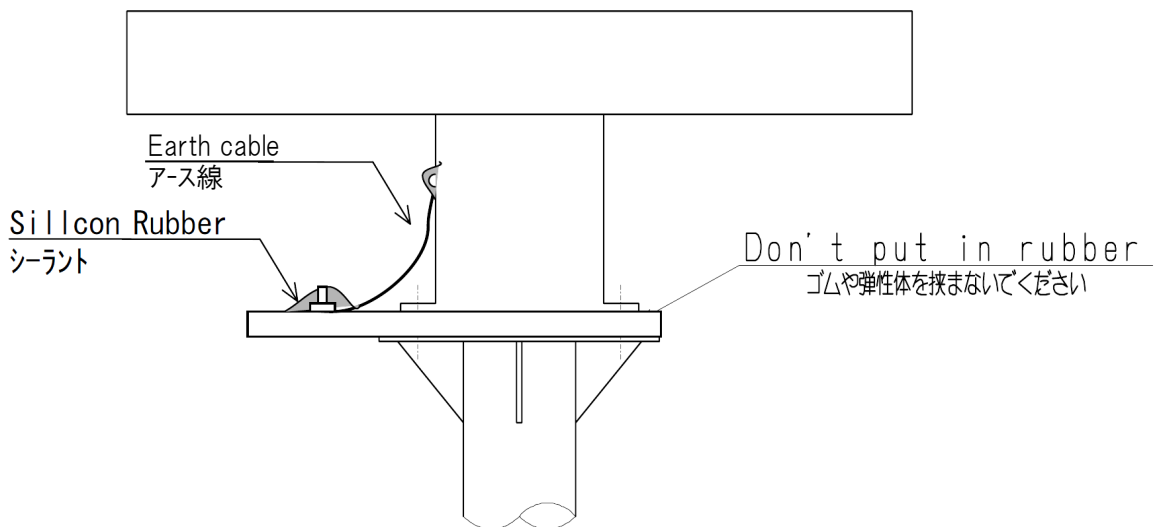
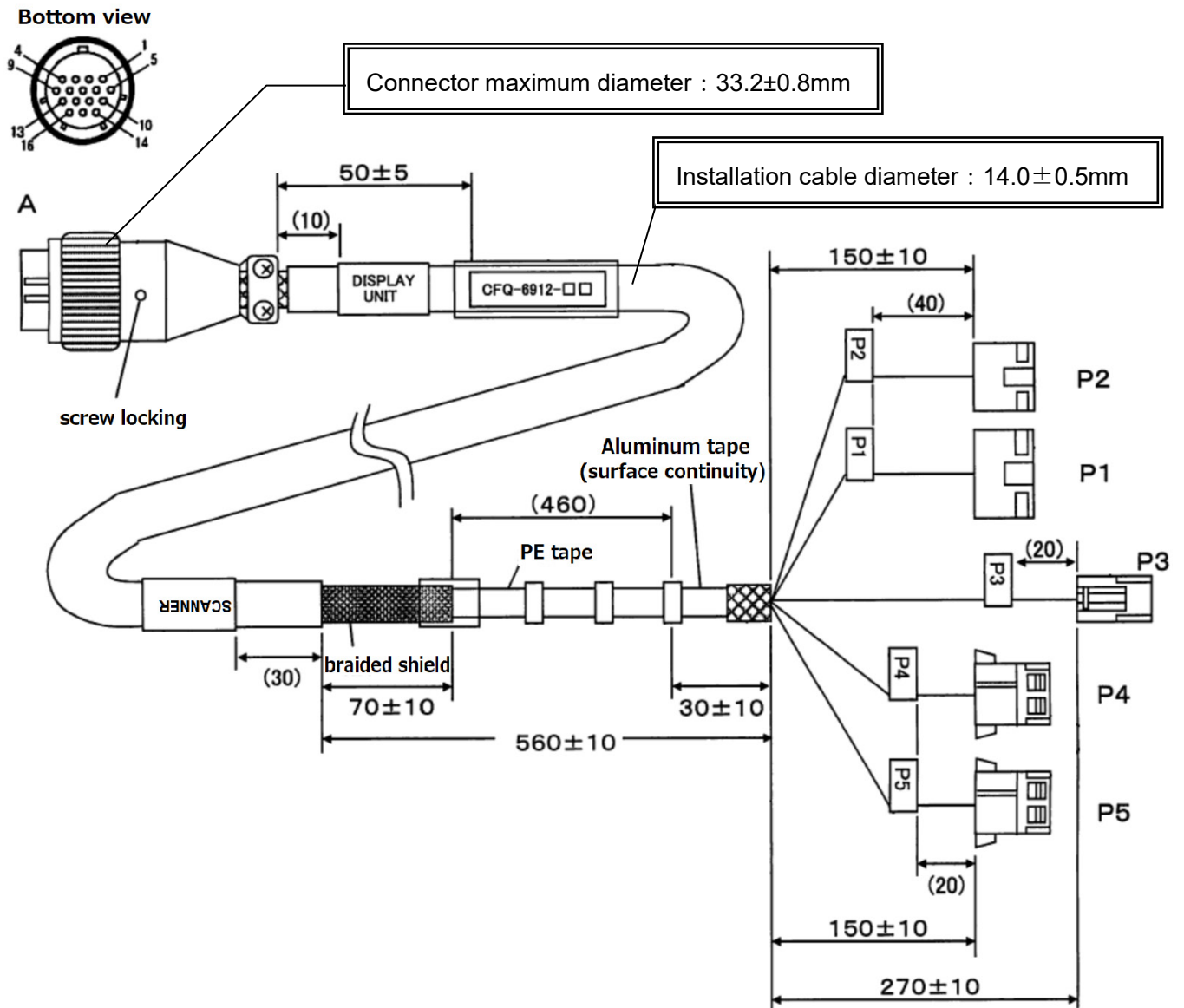

Fig 1-3-6-12

## 1.4 CONNECTING THE INSTALLATION CABLE

### ■ Installation cable



( unit : mm)

Fig. 1-4-1

※When installing the optional "rubber cap", attach it to the A connector side after laying the cable.

### 1.4.1 NKE-2043 SCANNER (2 FEET)

Set the cable inlet side to stern.

(Any direction is possible to install and possible to initial setup, but it is better selection to select the cable length must be minimize along the mast.)



Fig. 1-4-1-1

#### ■ Open radome

Loosen the screws by using box spanner tool, then you can lift up the radome.

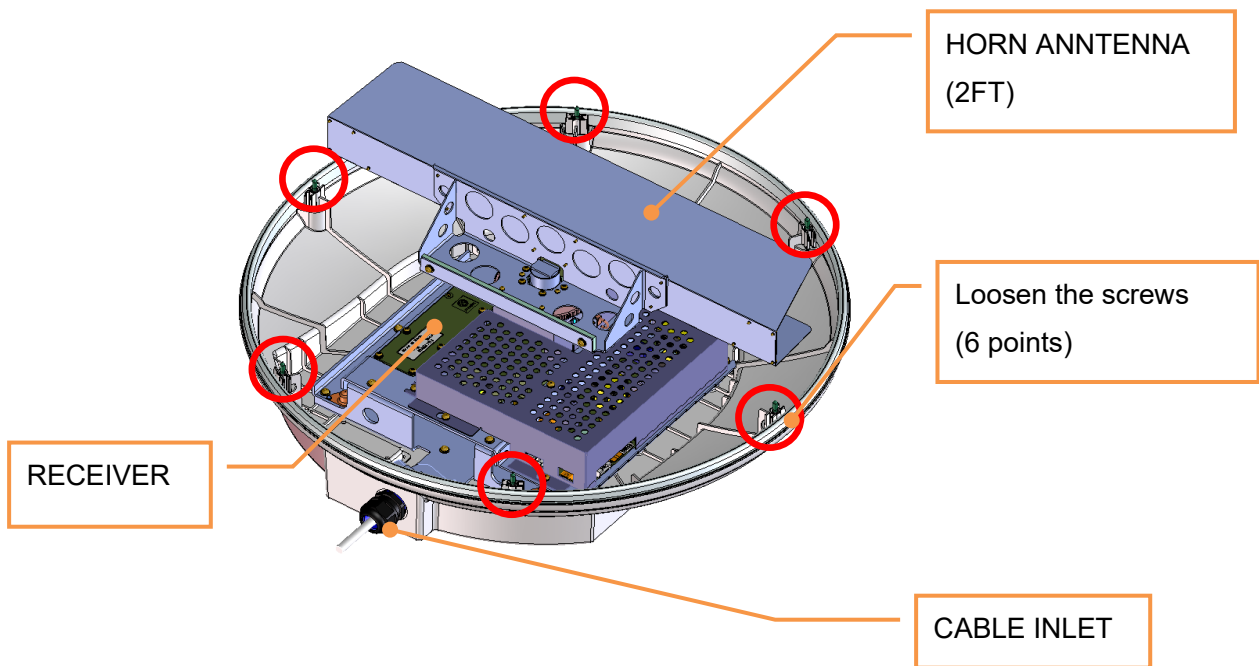

Fig. 1-4-1-2



■ NKE-2043

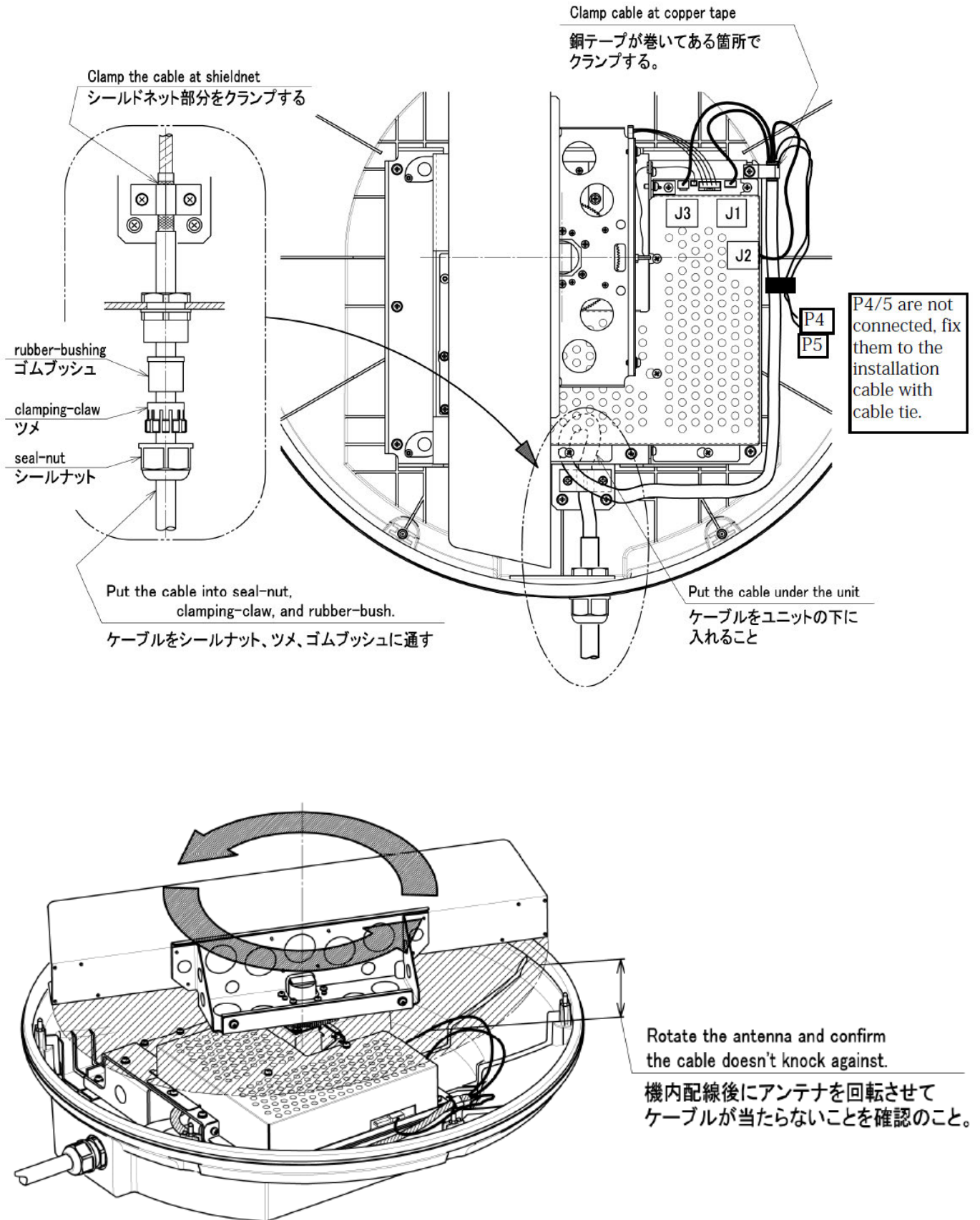
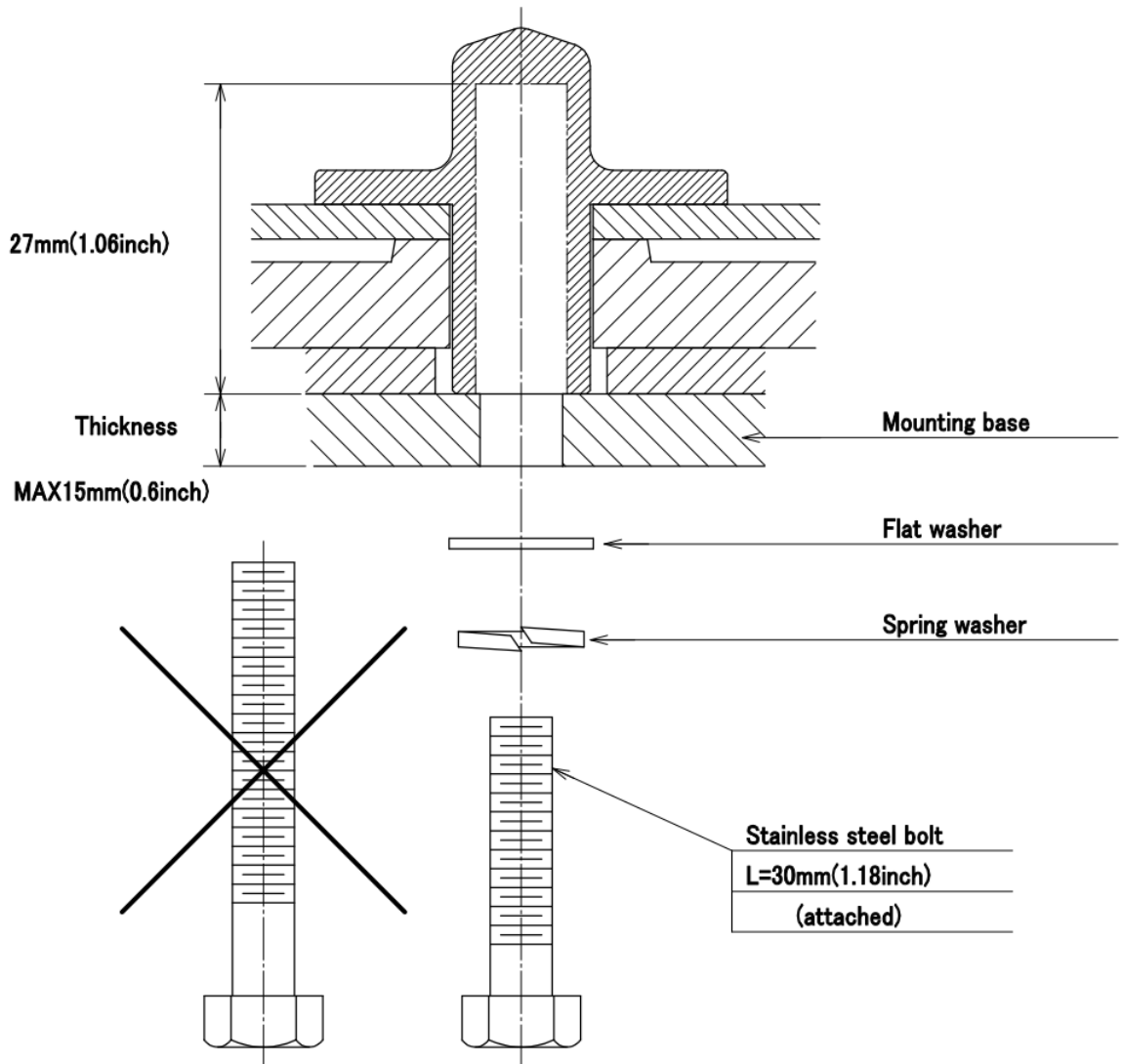

Fig. 1-4-1-3

# ⚠ CAUTION



When mounting the scanner unit, please check the maximum length of the holding bolts. If the bolts are too long, it gives severe damage to inside of the scanner. When mounting the scanner unit, please use the attached bolts. The mounting base thickness must not exceed 15mm (0.6inch).



※ FIX THE BOLTS BY USING A STANDARD WRENCH (LENGTH 135mm TORQUE 2058[N•cm])

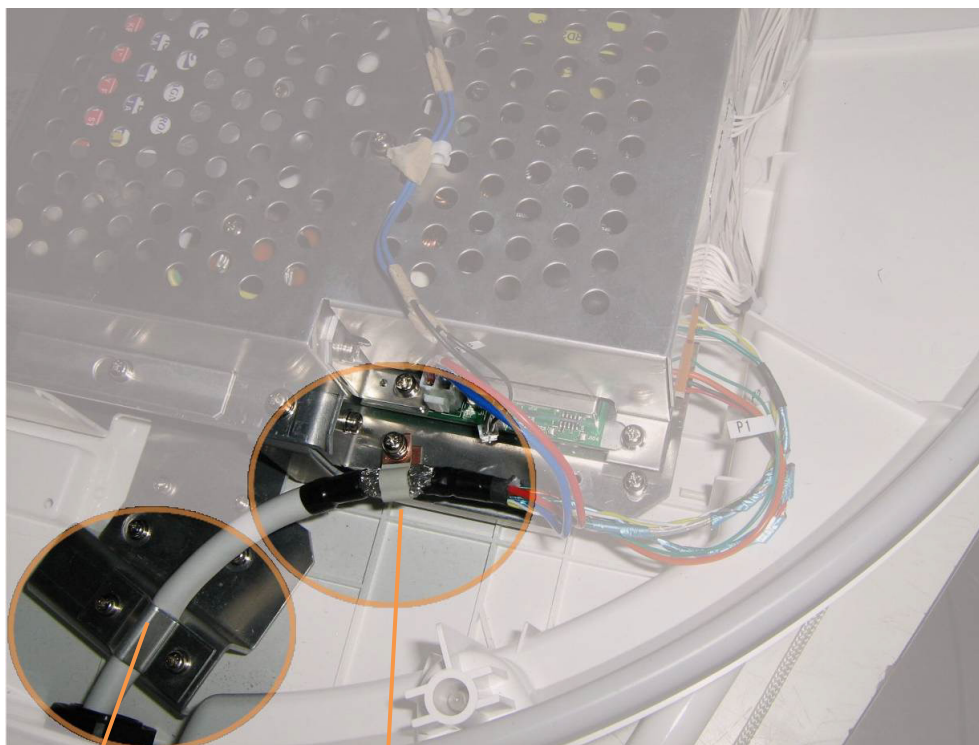

Fig. 1-4-1-4

Clamp the cable

Connect cable mesh wire as Ground.

■ **Close radome**

Attach the radome. Set to fit the triangle mark of the upper and lower radome.

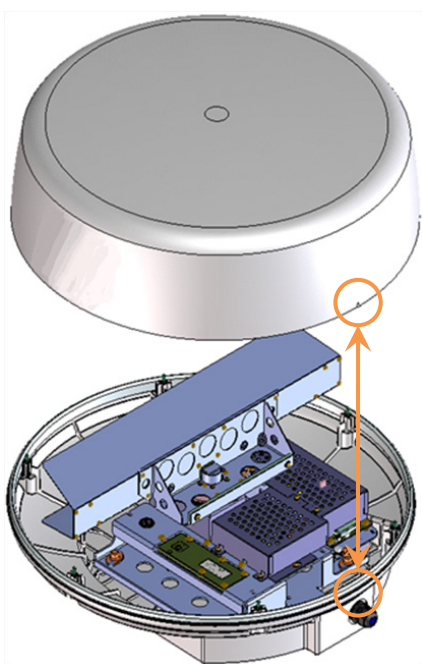

Like this

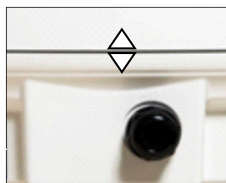
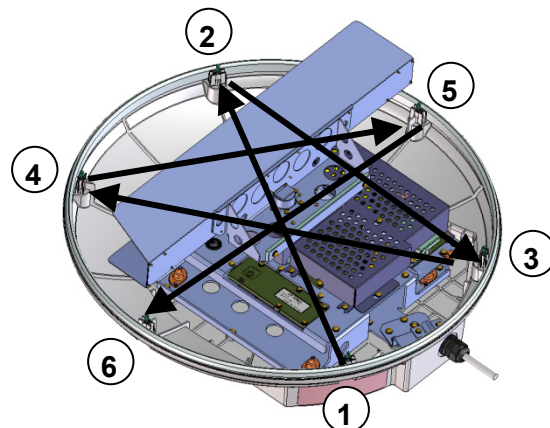

Fig. 1-4-1-5

In the following order, on the diagonal, tighten gradually in order to press uniformly packing.

The proper fastening torque of the fitting bolts (M5) is 102.96 N·cm (10.5kgf·cm).



6-M5 (stainless steel) bolt

Tightening torque: 10.5

## 1.4.2 NKE-2063A SCANNER (3.9 FEET)

Install with the cable insertion port facing the stern.

We recommend minimizing the length by laying the cables along the mast.



Fig. 1-4-2-1

### ■ Attach the scanner unit

Pass the spring washer and brass washer through the attached mounting bolts, and fix with the flat washer, the spring washer, the nut, and the nut.

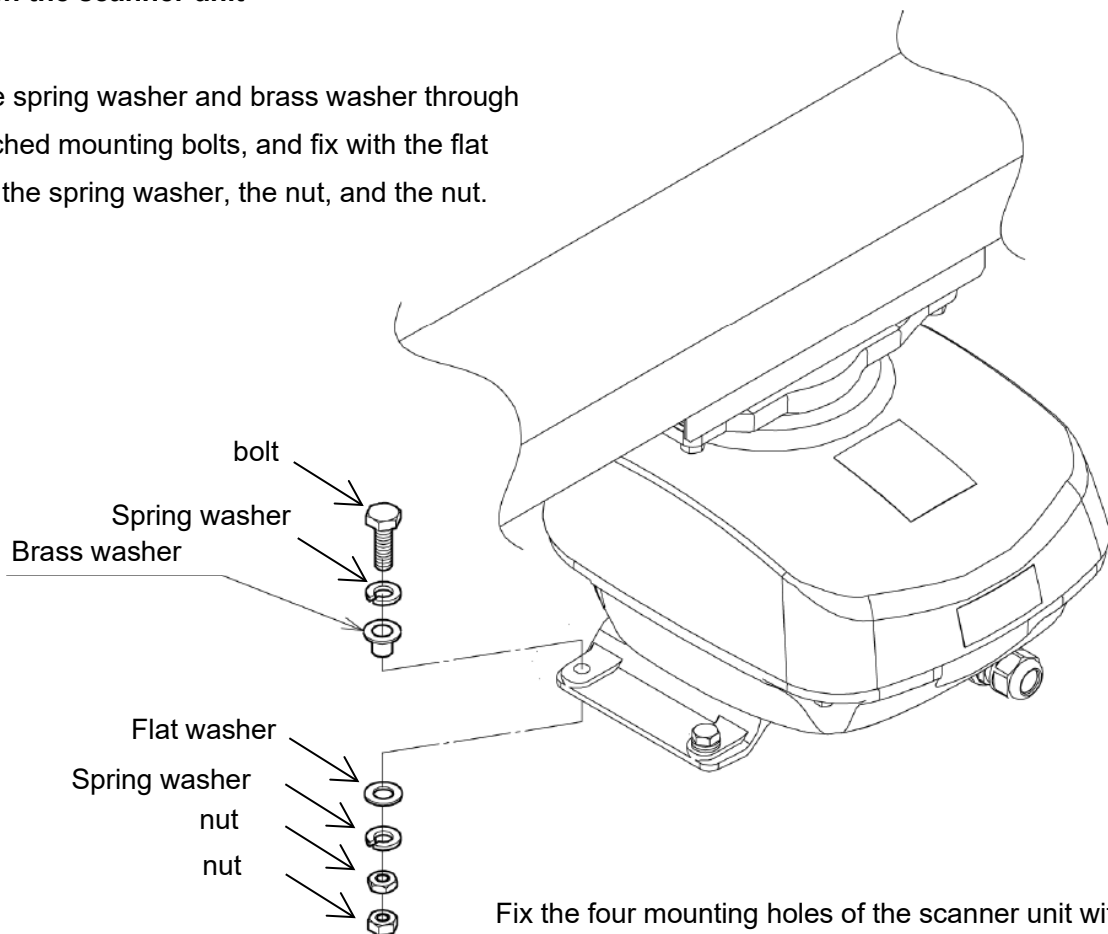

Fig. 1-4-2-2

■ Installing the scanner unit cable

Using a wrench (size 13), slowly open the top cover while loosening the four screws and supporting the antenna.

If you open it vigorously, the hinge may be damaged.

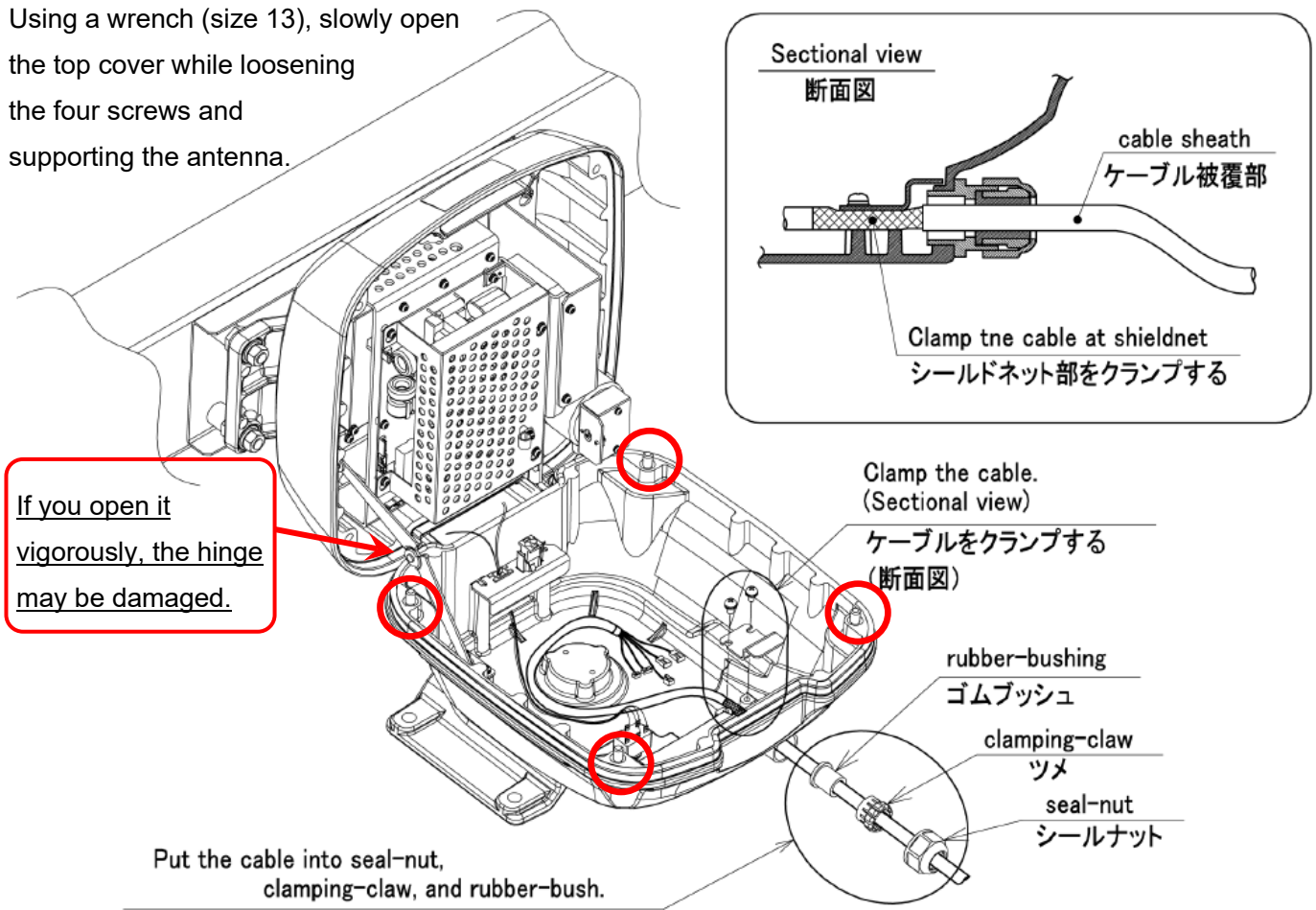
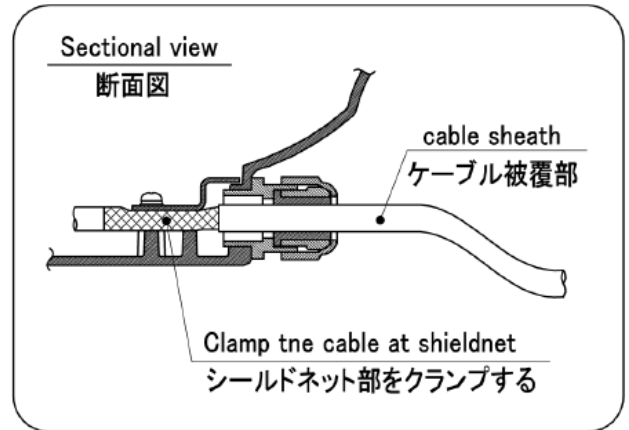
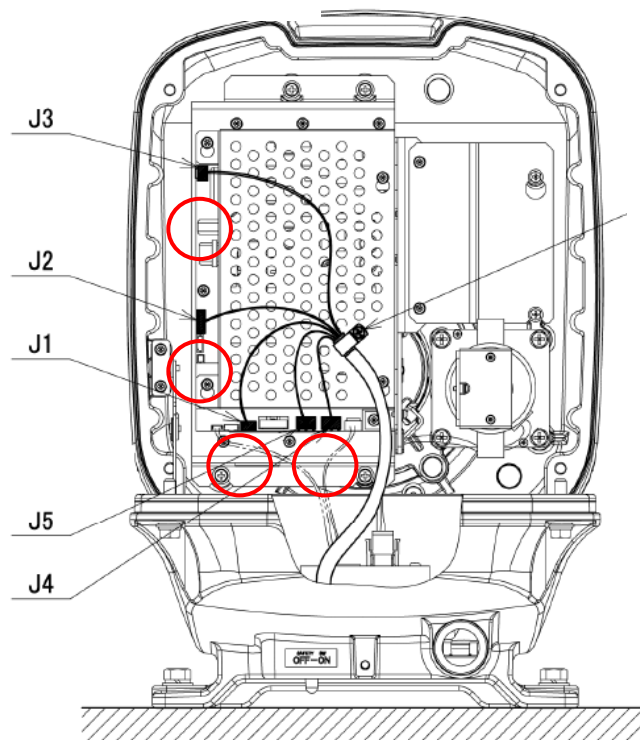

Fig. 1-4-2-3

Connect the connectors from J1 to J5.



Clamp cable at copper tape.

After connecting the connector, close the upper cover slowly and tighten the four screws.

Fig. 1-4-2-4

To uniformly press the packing, gradually tighten diagonally in the following order.

The proper fastening torque of the fitting bolts (M8) is 1176 to 1470 N•cm (120 to 150kgf•cm).

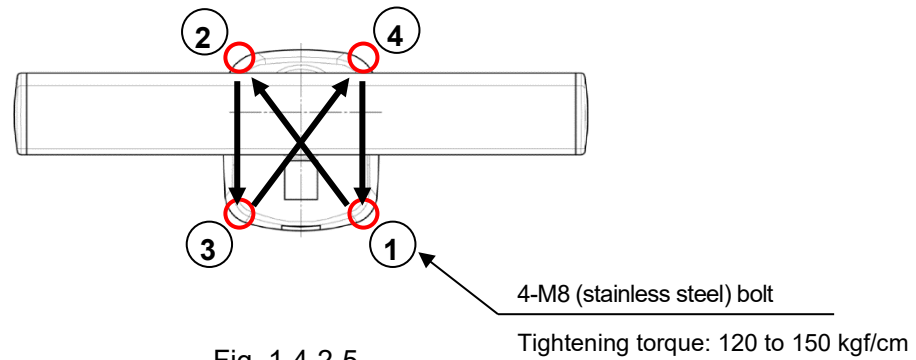

Fig. 1-4-2-5

Bolt the earth to mountbase and scanner.

Apply silicone sealant around the bolts.

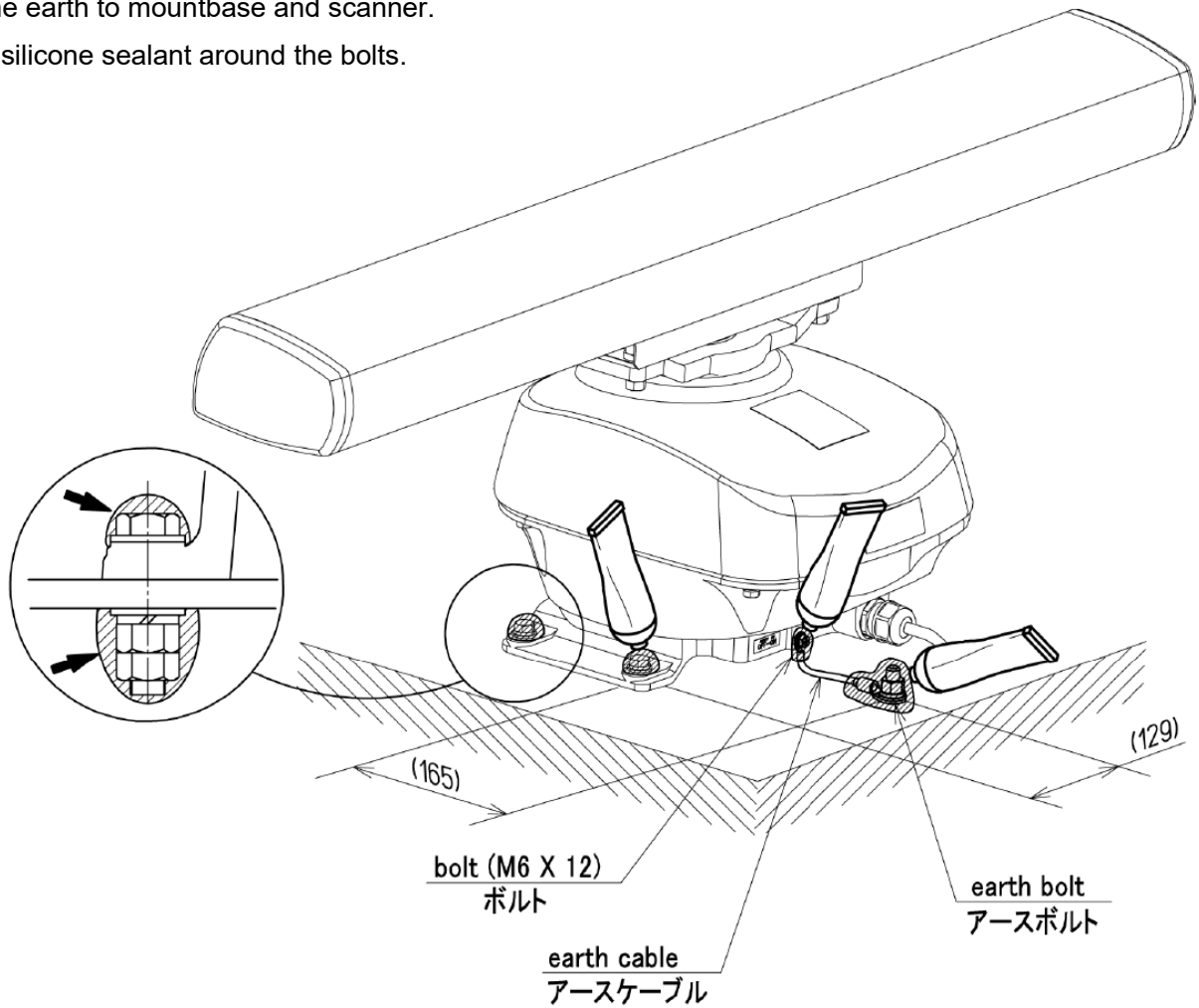

Fig. 1-4-2-6

### 1.4.3 NKE-2063AHS SCANNER (3.9 FEET)

Install with the cable insertion port facing the stern.

We recommend minimizing the length by laying the cables along the mast.



Fig. 1-4-2-1

#### ■ Attach the scanner unit

Pass the spring washer and brass washer through the attached mounting bolts, and fix with the flat washer, the spring washer, the nut, and the nut.

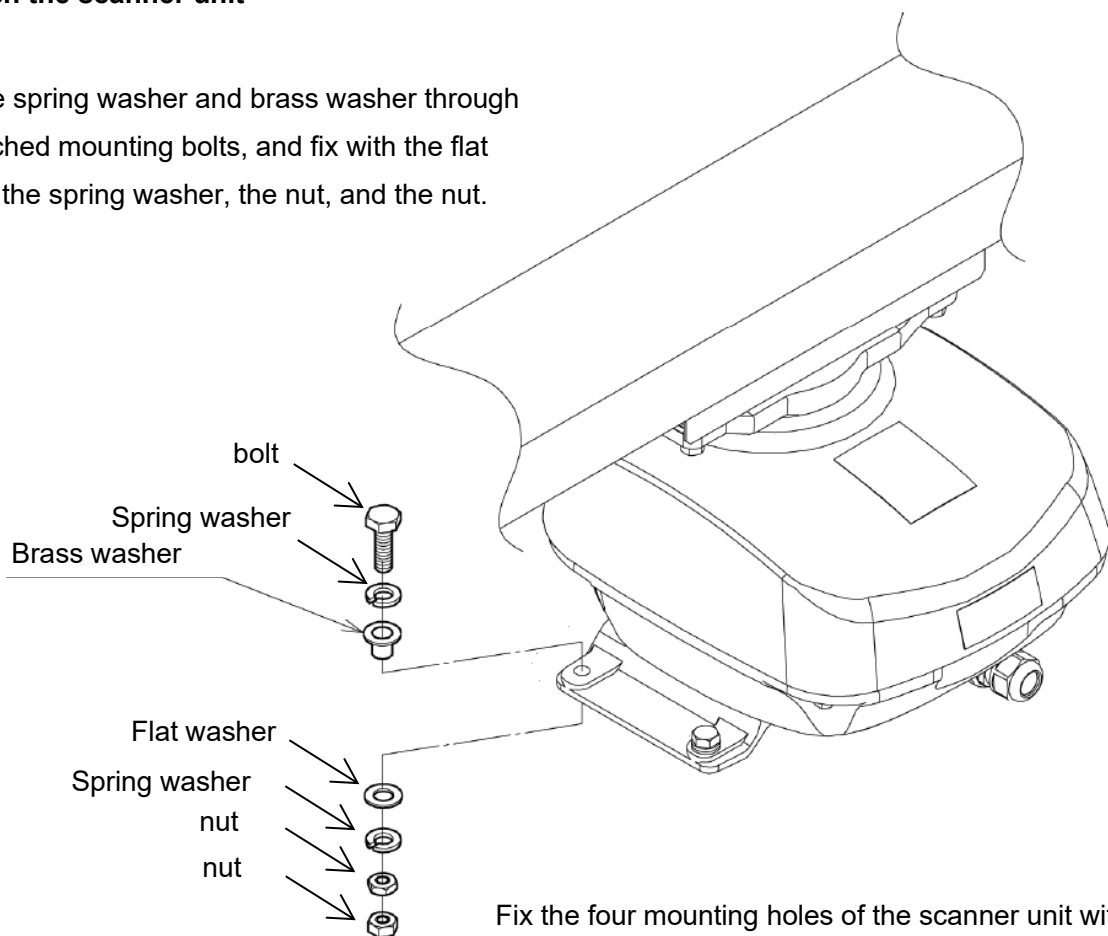

Fig. 1-4-2-2

■ Installing the scanner unit cable

Using a wrench (size 13), slowly open the top cover while loosening the four screws and supporting the antenna.

If you open it vigorously, the hinge may be damaged.

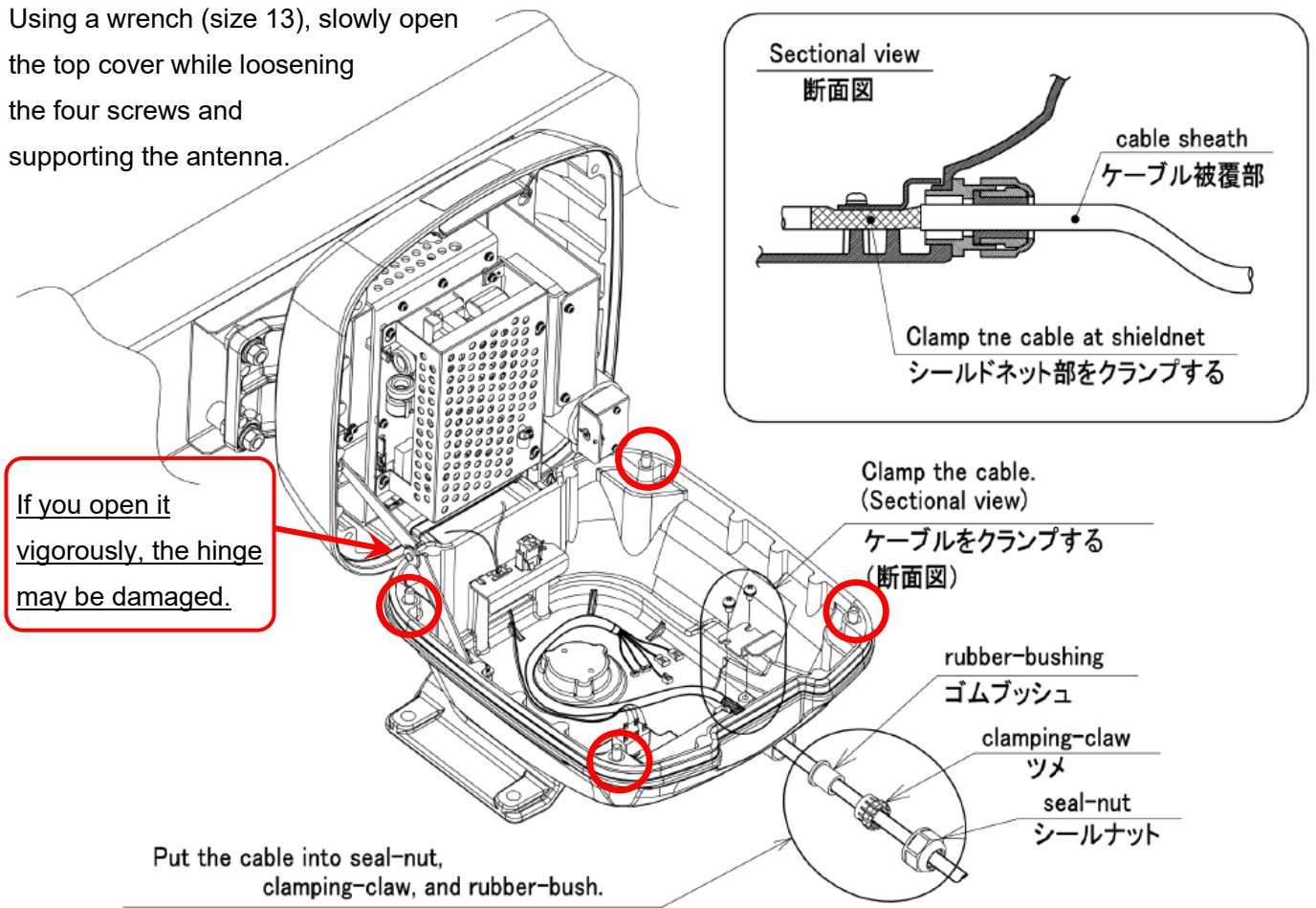
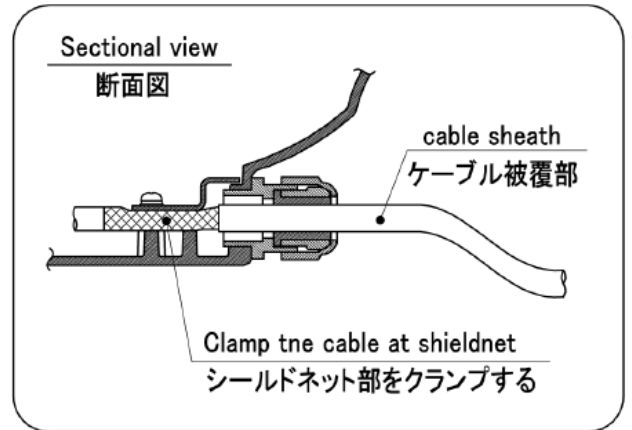

Fig. 1-4-3-3

Connect the connectors from J1 to J5.

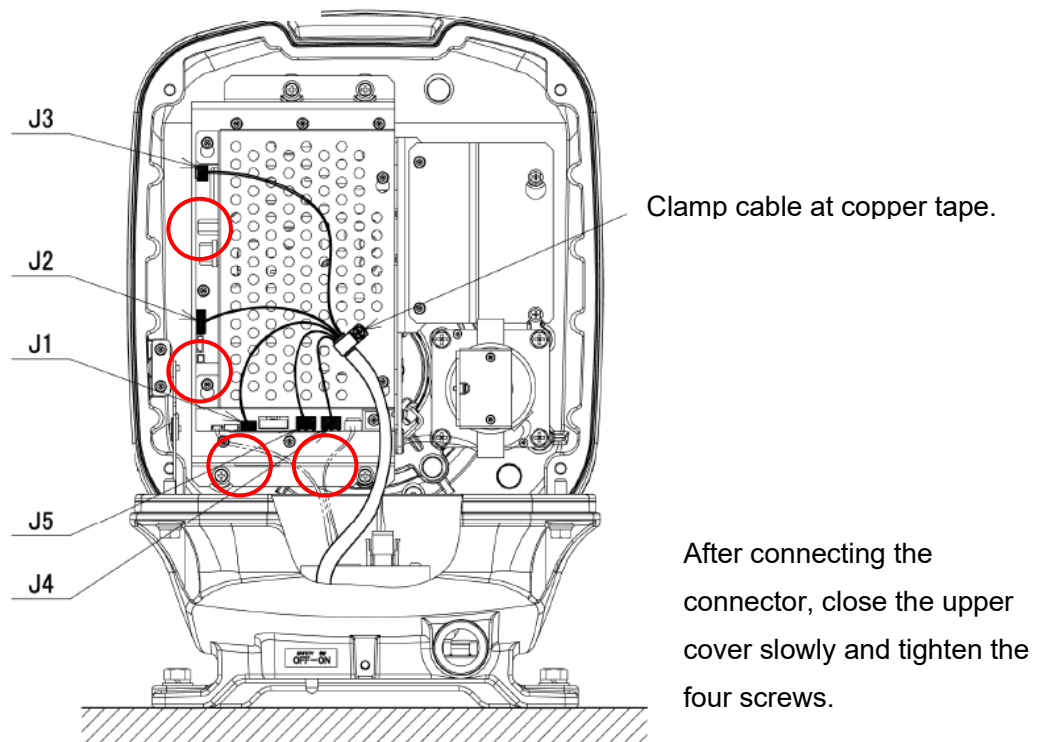

Fig. 1-4-3-4



To uniformly press the packing, gradually tighten diagonally in the following order.

The proper fastening torque of the fitting bolts (M8) is 1176 to 1470 N•cm (120 to 150kgf•cm).

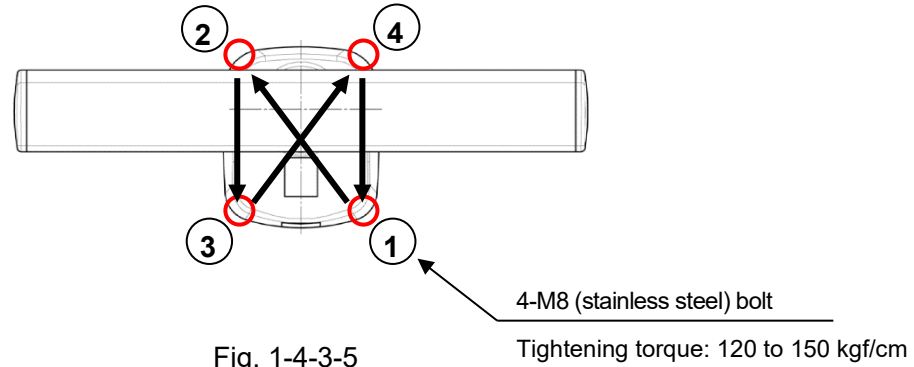

Fig. 1-4-3-5

■ Fastening of earth cable and application of seal

Bolt the earth to mountbase and scanner.

Apply silicone sealant around the bolts.

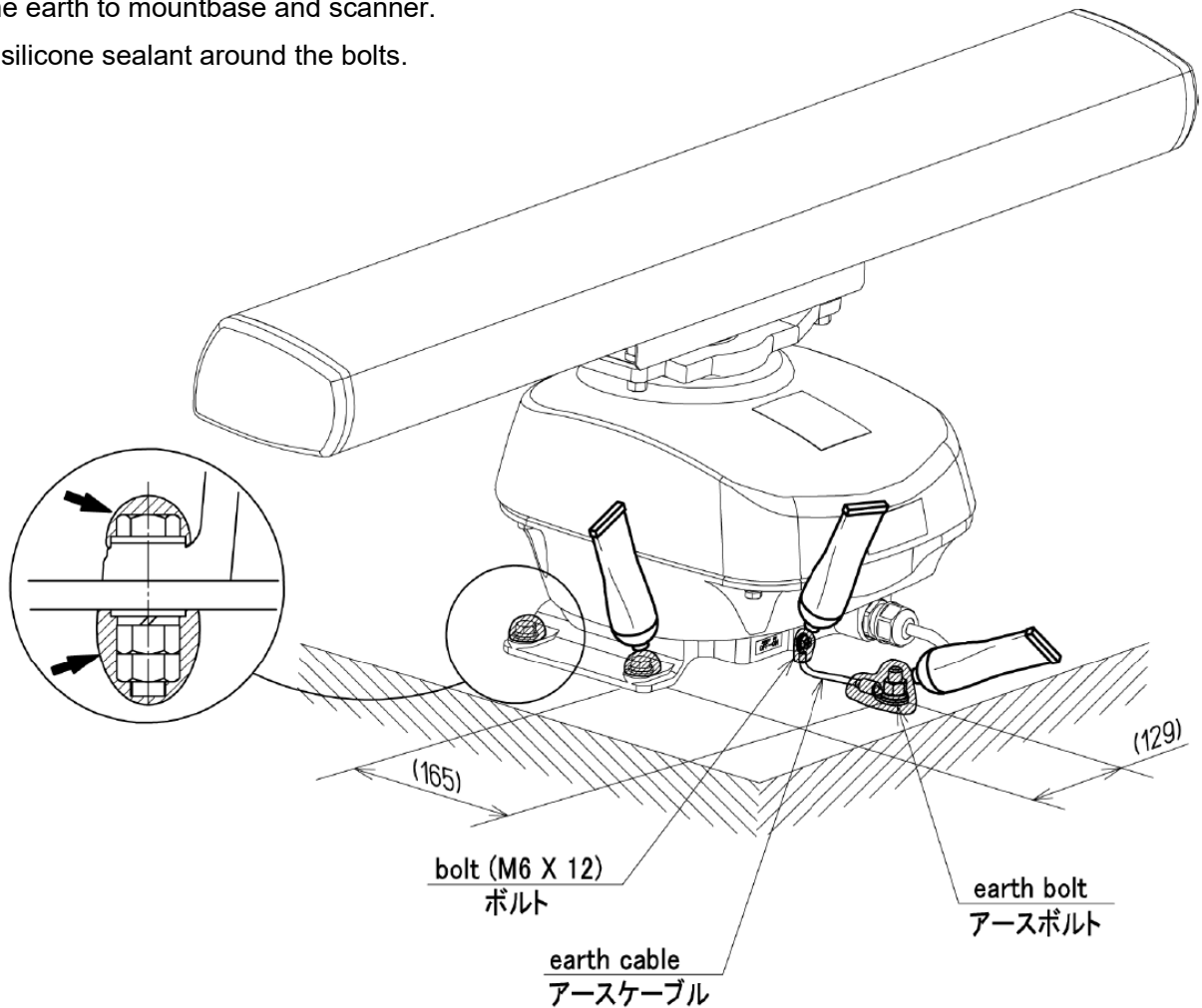

Fig. 1-4-3-6

## 1.4.4 NKE-2103-4/6 SCANNER (4 FEET/6 FEET)

### ■ NKE-2103

1. Put the cable into cable gland washers and gasket.  
Tear the tape.

ケーブルをワッシャ、ガスケット、グラッドに通し、テープを剥がす。

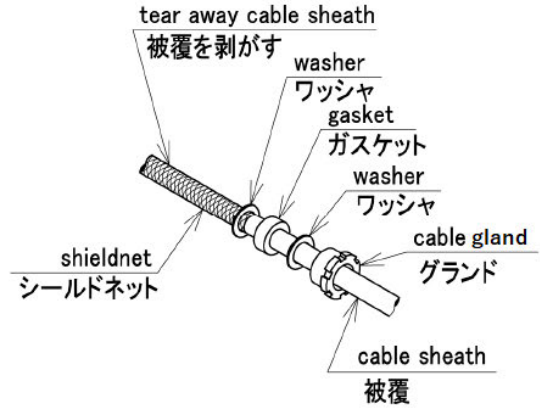

2. Unknit shield net and wrap it around a washer.  
シールドネットをほどき、ワッシャに巻き付ける。

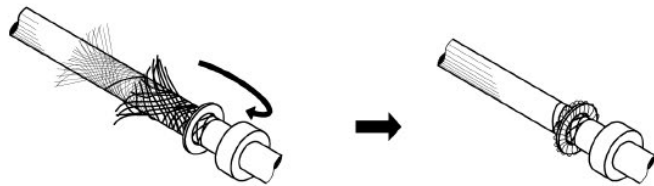

3. Equip the scanner unit with brass-washers: appended.

黄銅製ワッシャを用い、空中線を装備する。

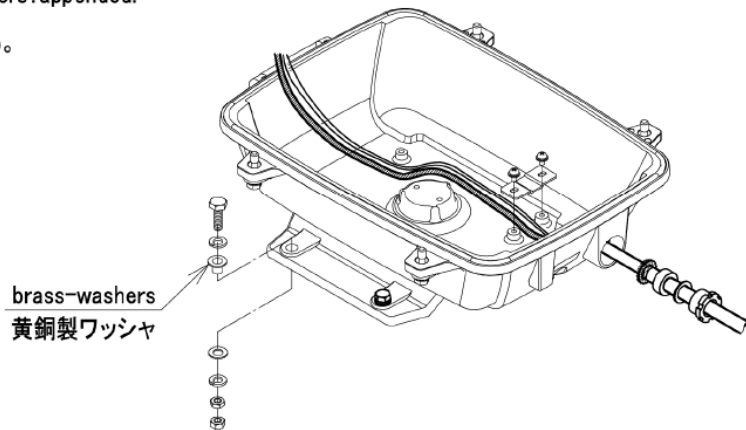

4. Cut the shield ribbon and the vinyl covering from current position to 50mm lower part and then put the copper tape again.

既存の位置から50mmシールドリボンとビニールカバーを剥いて切断し、銅テープを貼り直してください。

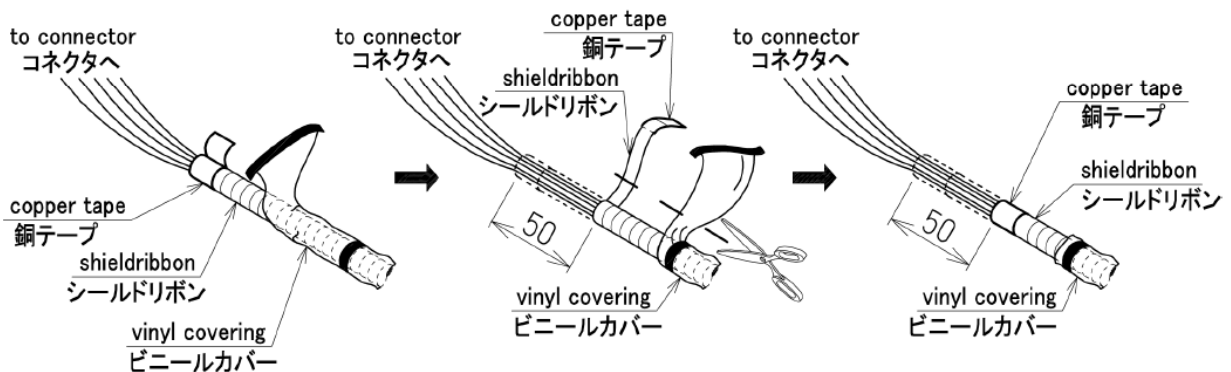

5. Clamp the cable, connect 5 terminals and connector.

ケーブルを各部でクランプし、端子とコネクタを接続する。

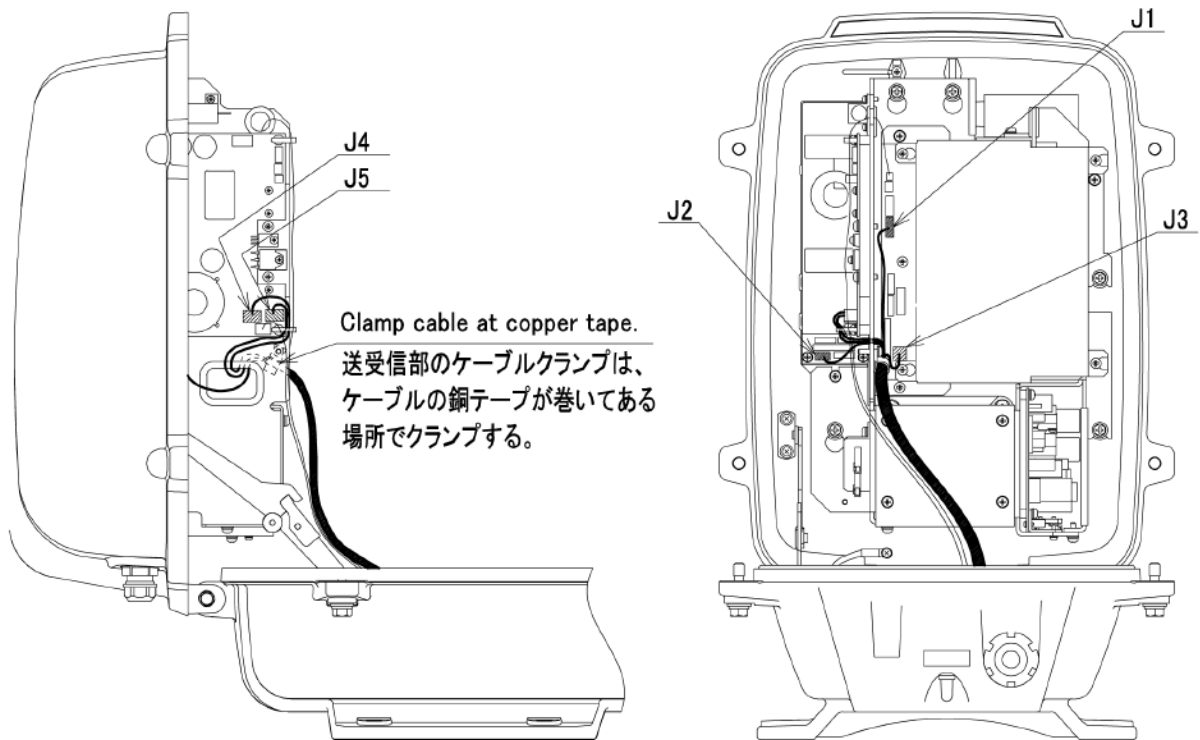

6. Apply silicone sealant around the bolts and into the cable inlet.

ボルトの周辺部とケーブルグランド部をシールする。

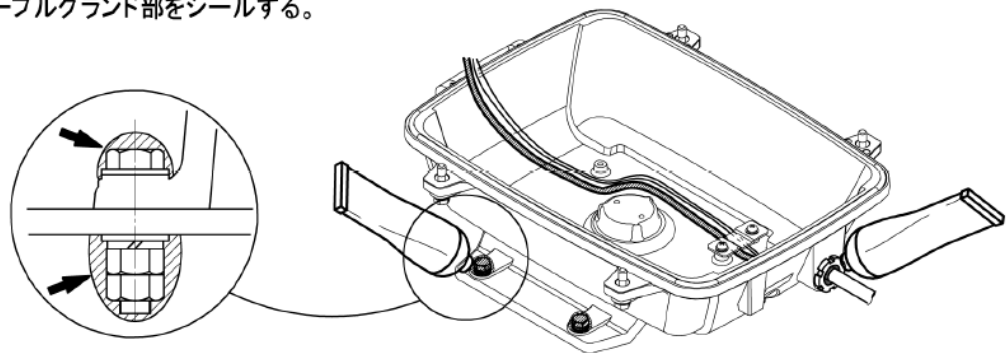

7. Bolt the earth cable to mountbase and scanner.

Apply silicone sealant around the bolts.

アースケーブルをボルトで締結後、締結部分を全てシールすること。

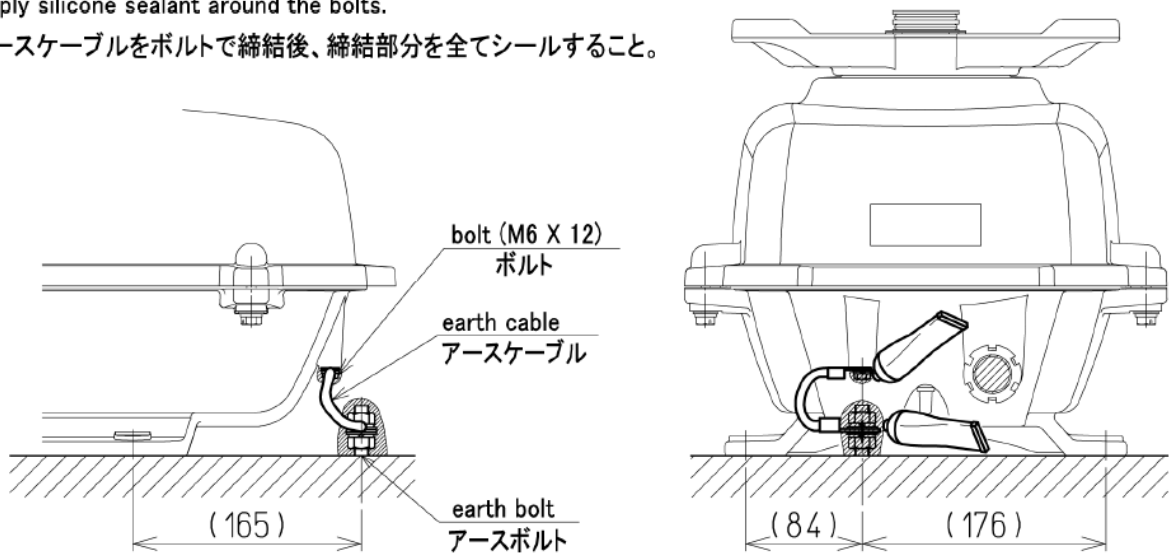

# Chapter 2 THE BASIC OPERATION

If the basic adjustment is made by the serviceman beforehand, please run it as it is.

(In the case of no adjustment is done by the serviceman beforehand, you had better grasped the operation of this radar through referring to Chapter 5, then please perform the initial settings that are listed in Chapter 7.)

## 2.1 PANEL AND SCREEN DISPLAY LAYOUT

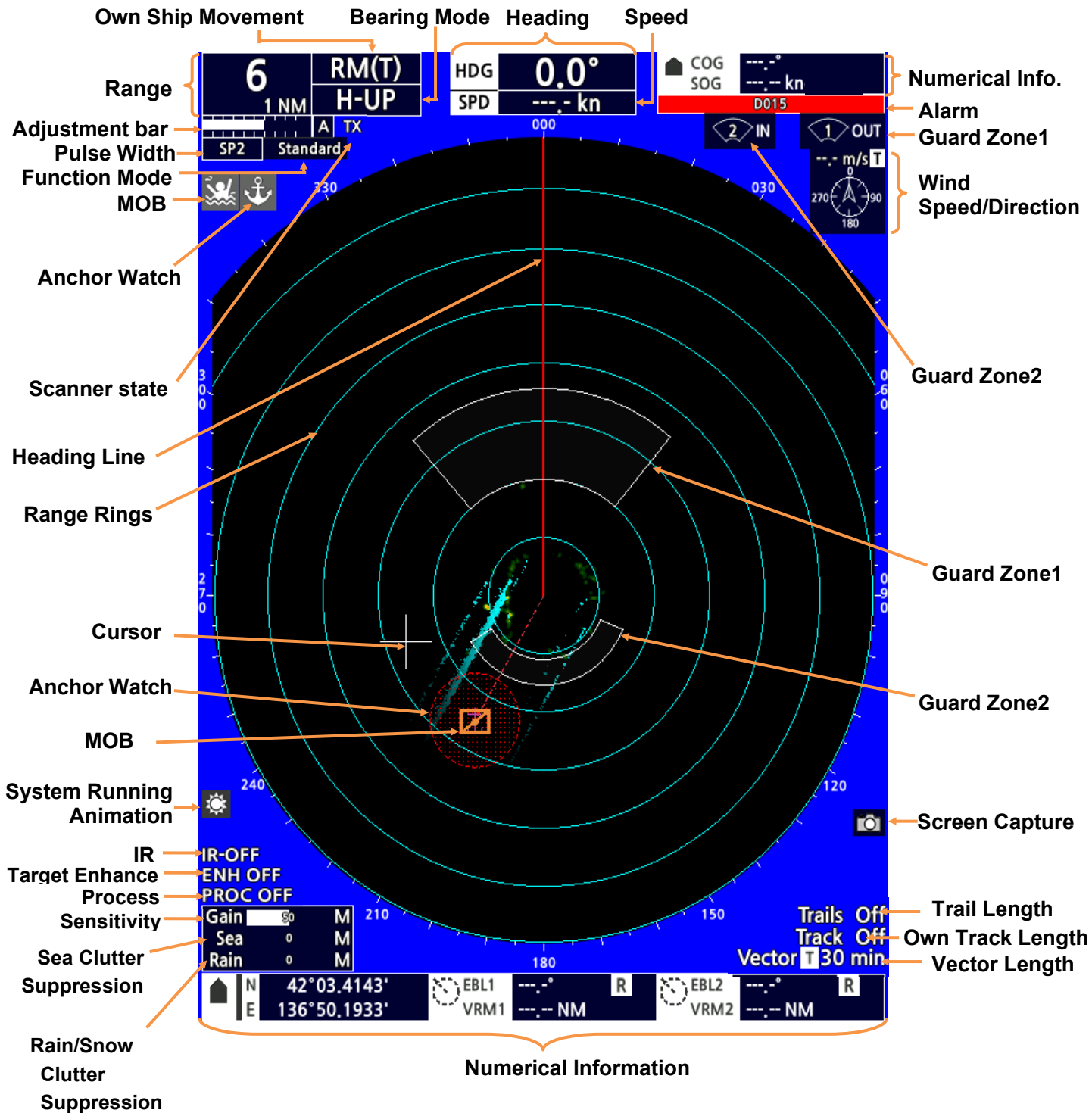

## 2.2 OPERATION UNIT

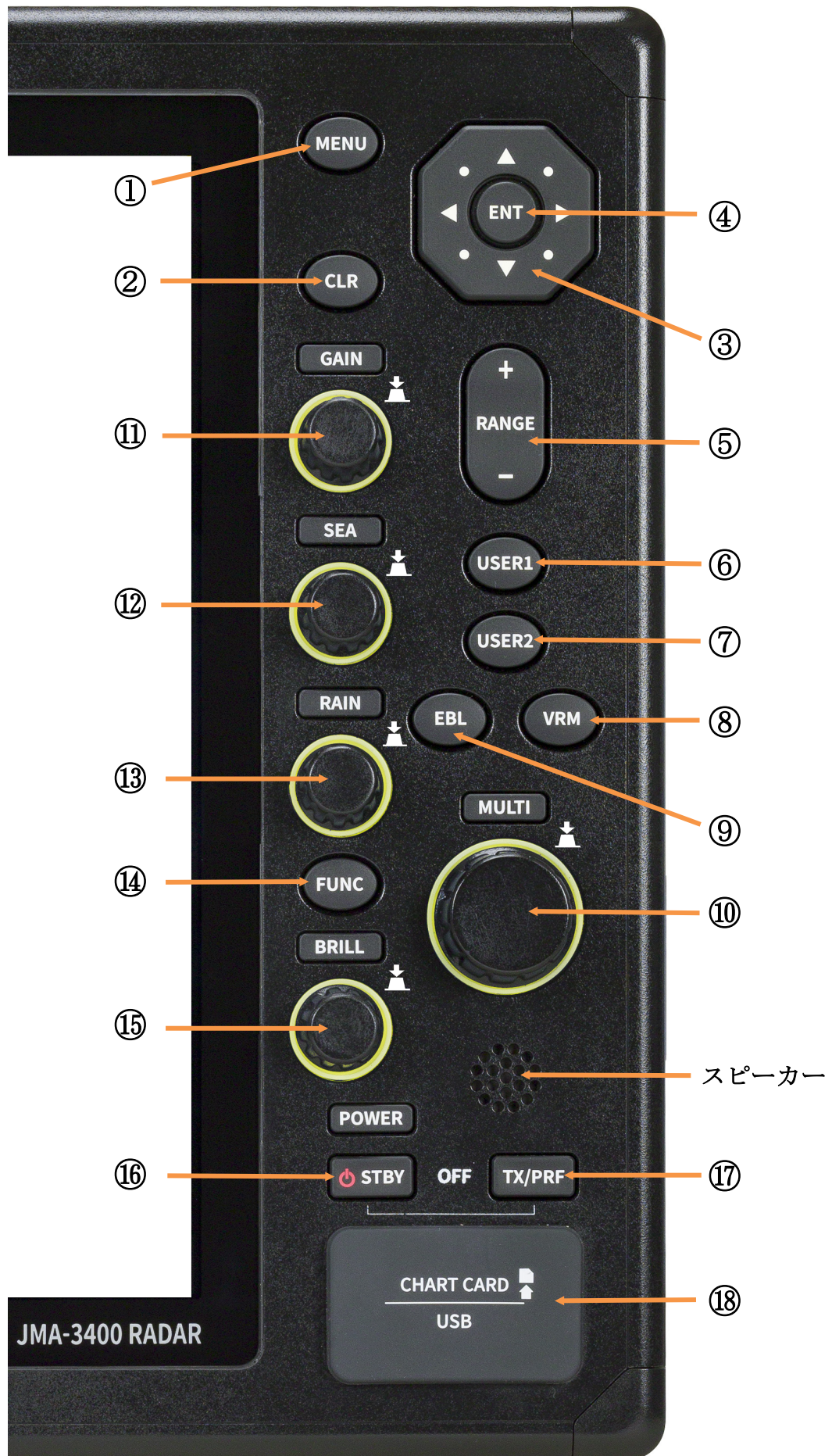

No.	Name	Description
①	MENU button	Press: Open/Close the menu. Long press: Open the code input screen (the Adjust Menu).
②	CLR button	Press: Cancel menu operations. Return to upper menu. Stop the alarm sound. Long press: Cancel menu operations.
③	Cross key	Press: Select menu items. Moves the cursor. Long press: Accelerate cursor movement.
④	ENT button	Press: Enter the selected menu item. Long press: Register menu shortcut to the USER1 button and USER2 button.
⑤	RANGE button	Press: Switch the range.
⑥	USER1 button	Press/Long press: The menu registered in the "User" menu of the in Main Menu open.
⑦	USER2 button	Press/Long press: The menu registered in the "User" menu of the in Main Menu opens.
⑧	VRM button	Press: Display VRM1, and change to VRM operation mode. Press twice: Display VRM2, and change to VRM operation mode. Long press: Turn off the VRM1 or 2 which is selected by short pressing the VRM button.
⑨	EBL button	Press: Display EBL1, and change to EBL operation mode. Press twice: Display EBL2, and change to EBL operation mode. Long press: Turn off the EBL1 or 2 which is selected by short-pressing the EBL button.
⑩	MULTI control	Press: When no menu is displayed, the MULTI control menu is displayed. While any menu is displayed, determine the item selection on the menu. Long press: Turn off the several functions, etc. Turn right: Move the cursor to the right when any menu is not displayed. Move clockwise EBL direction when EBL operation. Increases VRM ring size when VRM operation. Moves clockwise the parallel cursor direction when parallel cursor operation. Increase the value when inputting a numerical value.
⑩	MULTI control	Turn left: Move the cursor to the left when any menu is not displayed. Move counterclockwise EBL direction when EBL operation.

No.	Name	Description
		<p>Decrease VRM ring size when VRM operation.</p> <p>Move counterclockwise the parallel cursor direction when parallel cursor operation.</p> <p>Decrease the value when inputting a numerical value.</p> <p>Turn right while pressing:</p> <p>Move the cursor up when any menu is not displayed.</p> <p>Increase the width of parallel cursor when parallel cursor operation.</p> <p>Turn left while pressing:</p> <p>Move the cursor down when any menu is not displayed.</p> <p>Decrease the width of parallel cursor when parallel cursor operation.</p>
⑪	GAIN control	<p>Press: Switch the sensitivity between manual and automatic modes.</p> <p>Turn: Adjust receiving sensitivity.</p>
⑫	SEA control	<p>Press: Switch the sea clutter suppression function between manual and automatic modes.</p> <p>Turn: Remove sea clutter.</p>
⑬	RAIN control	<p>Press: Switch the Rain/Snow clutter suppression function between manual and automatic modes.</p> <p>Turn: Removes Rain/Snow clutter.</p>
⑭	FUNC button	<p>Press: Switch function mode. [OFF -&gt; Standard -&gt; Coast -&gt; Deepsea -&gt; Fishnet -&gt; Bird -&gt; User]</p> <p>Long press: Turns off function mode.</p>
⑮	BRILL control	<p>Press: Switches the brilliance mode. [Day-&gt;Dusk-&gt;Night]</p> <p>Long press: Changes brilliance level to MAX (100).</p> <p>Turn: Changes the display brilliance.</p>
⑯	STBY button	<p>Press: Turn on this equipment (when it is turned off). Turn to standby state (when the equipment is transmitting). Turn off the equipment when pressed together with the TX/PRF key.</p> <p>Long press: Long press for more than 20 seconds to forcibly terminate the display unit.</p> <p><b>Caution:</b> If you forcibly terminate it, it may not operate normally after restarting. Except for emergencies such as when the display unit stops responding, turn off the unit by press the STBY + TX/PRF button.</p>
⑰	TX/PRF button	<p>Press: Start transmitting (in standby state).</p>

No.	Name	Description
		Tune the repetition frequency (when transmitting). Long press: Turn off the heading line.
⑮	USB/Chart Card	USB: Insert USB to save files and update software. Chart Card: Insert SD card to display map (new pec/Navionics+).



## 2.3 POWER ON/OFF

# ⚠ CAUTION



A malfunction may occur if the power in the ship is instantaneously interrupted during operation of the radar. In the case, the power should be turned on again.



When the display unit is turned off by the power drop, power supply to the scanner unit also stops. Make sure that the supply voltage to the display unit is stable, the power should be turned on again.

### Note:

- Wait for about 2 seconds before turn on the power again.
- Immediately after the radar is installed, at start of the system after it has not been used for a long time, or after the magnetron is replaced, preheat the equipment in the standby state for 20 to 30 minutes before setting it into the transmit state.
- If the preheating time is short, the magnetron causes sparks, resulting in its unstable oscillation. Start transmission on a short-pulse range and change the range to the longer pulse ranges in turn. If the transmission is unstable in the meantime, immediately place the system back into the standby state and maintain it in the standby state for 5 to 10 minutes before restarting the operation. Repeat these steps until the operation is stabilized.

### ■ Power on

(90 seconds preheat time is required for cold start, because of the Magnetron heater.)  
After 90 seconds, anytime transmitting is possible.



Press the STBY button

Opening screen

Preheating time display  
(Preheating time : 90 seconds)

### Reference:

The radar cannot start transmission if you press the TX/PRF icon while the preheating time is displayed.

■ Power off

# ⚠ CAUTION



Be sure to turn off the power with power off operation.  
If the operating is not observed, some setting values force to initialize values,  
or numerical and icons are not displayed by the software files broken  
depending on the software work situation.

Power off



Press STBY + TX/PRF button

## 2.4 SCREEN LAYOUT

### 2.4.1 STANDBY SCREEN

#### ■ Standby screen

Standby screen is selectable from below 5 types.

Standby screens can be switched by STBY button.

#### ① Normal screen

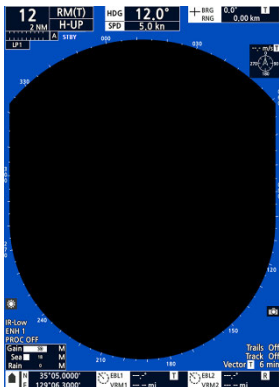

#### ② Graphical screen Vessel speed and course



#### ③ Graphical screen Wind speed and direction



#### ⑤ Numerical screen



#### ④ Graphical screen Temperature and depth

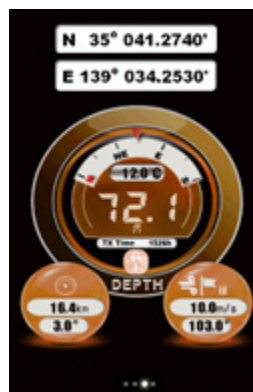

#### Note:

- Initial settings are required to display screens ② to ⑤.  
Refer to "8.9 SCREEN DISPLAY" for setting.
- Even on the screens of ②, ③, ④, and ⑤ above, transmission can be performed by pressing the TX/PRF button.  
Then press the STBY button, return to the standby screen that was displayed before the TX/PRF button was pressed.

● Photo frame settings

Note : Works with the indicator software version 2.02 or later.

Any image file can be set to the standby screen.

Preparation)

Prepare an USB strage, the file format is FAT32. Insert the USB strage to the USB port of display unit front side. JMA-3400 folder creates (see right figure) automatically when you insert an empty USB stick in the front USB port.

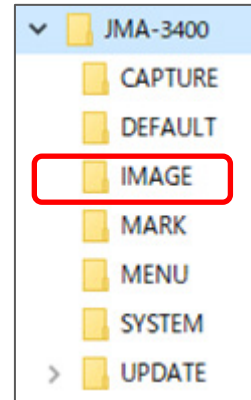

Prepare Photo files)

The photo file that you can display is only "png", and the file size of image about 333 kByte. Copy the photo file to the JMA-3400/IMAGE folder.

Settings)

- i ) MENU long press, code input is "0"+ENT, To enter the "Adjust Menu. Select 13.Display Screen/1.Standby Numeric Display".
- ii ) MENU long press, "77777"+ENT, this code is photo frame function switch to on/off.

Display photos)

- i ) Power on display. Wait until it goes to the Stand-By state.
- ii ) Set USB storage to front USB port. The USB that you prepared earlier with photos in JMA-3400/IMAGE folder.
- iii ) Press "STBY" button, the display change as below,



At the Photo Frame state, displays each picture in IMAGE folder for at 30s, and you can save one picture in display unit.

How to save a one photo)

Long press "ENT" when you want to save photo. The display unit sounds "Pi" for 2s when it saved the displaying photo.

How to delete a saved photo)

Long press "CLR" when it is displaying a saved photo. The display unit sounds "Pi" for 2s when it deletes the photo.

For your information

Even if the radar is set to photo frame screen, Pressing the "TX" button will cause the radar to start transmitting and the radar screen will be displayed.



Example

## 2.4.2 TRANSMISSION SCREEN

### ■ Starting transmission

Press the TX/PRF button

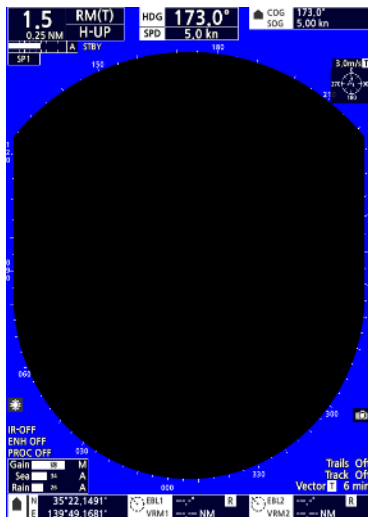

Transmit

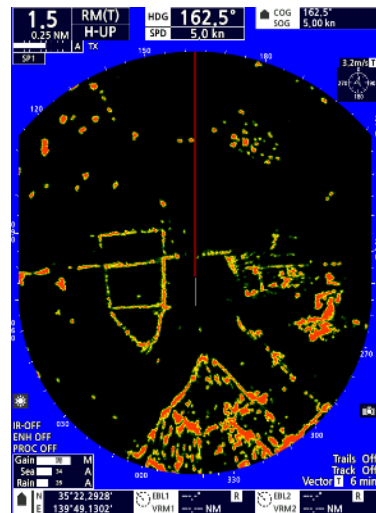

## ■ Stopping transmission

Press the STBY button

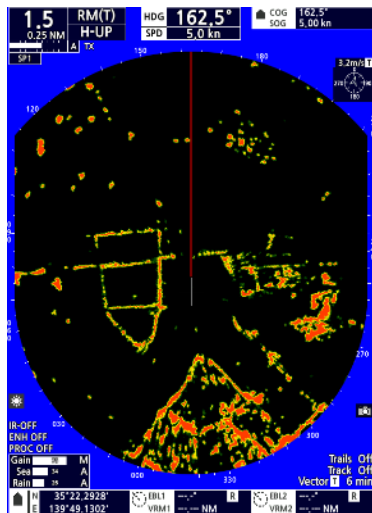

Standby

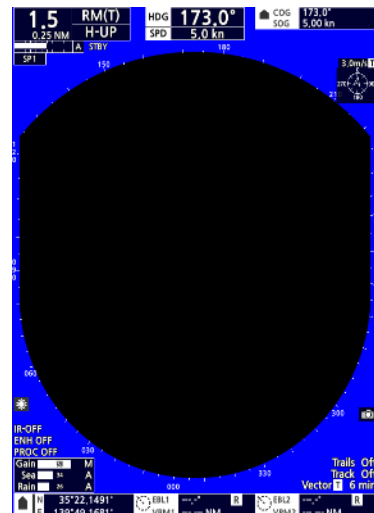

## 2.5 MULTI CONTROL OPERATION

### ● Basic operation of the MULTI control menu

1. Press the MULTI control, the MULTI control menu will be displayed.



Press the MULTI control, the MULTI control menu will be displayed.



No operation for about 30 seconds, the menu disappears automatically.



<b>EBL1</b>
EBL2
VRM1
VRM2
Parallel Cursor
MOB
Anchor Watch
Vector Length
Radar Trails
AIS
TT
OFF-CENTER
Mark
Line
Ownship Mark
Data Off
x

**MULTI**



2. Turn the MULTI control to move the menu focus.

Turning right: moves the focus down

Turning left: moves the focus up

The focus color is orange.

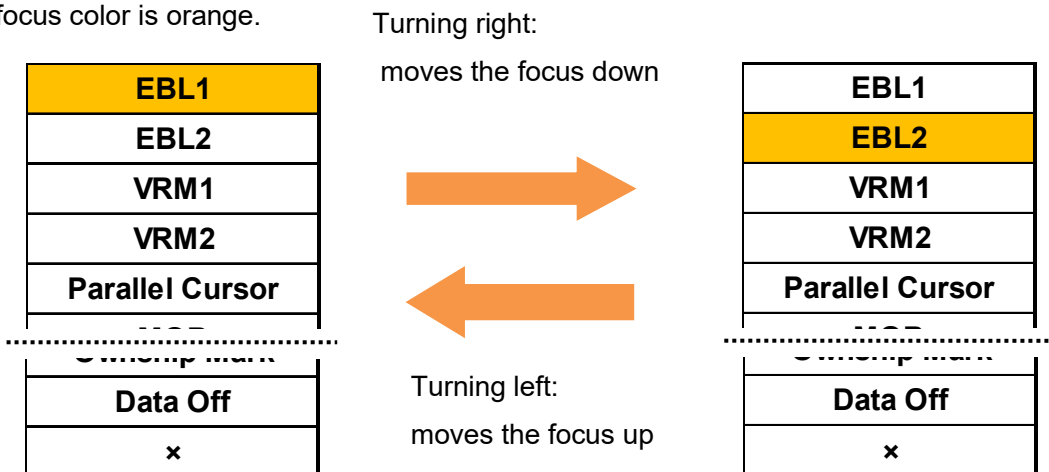

3. Move focus, and select by pressing the MULTI control (or ENT button).

4. The menu hierarchy can be returned by pressing the CLR button.

5. Basically, the menu ends when the second layer is executed.

~ How to close the MULTI control menu ~

- No operation for about 30 seconds, the menu disappears automatically.
- Press (or long press) the CLR button.
- Select "X" at the bottom of the MULTI control menu to close.

**Note:**

When the focus is at the top of the MULTI control menu, there is no item that can be selected by turning the MULTI control counterclockwise. Similarly, there is no item that can be selected by turning the MULTI control clockwise when it is at the bottom.

## 2.5.1 FUNCTION OVERVIEW OF MULTI CONTROL MENU

Menu	Description
EBL1, 2	Electric Bearing Line. Measure the target direction by using cursor line.
VRM1, 2	Variable Range Marker. Measure the target distance by using circle line.
Parallel Cursor	Displays 7 parallel lines. For adjusting the direction of the parallel cursor by turning the MULTI control. For adjusting the interval of the parallel lines by turning the MULTI control while pressing it.
MOB (Man Over board)	When the crew fall into over the board by accident. Carry out MOB function immediately. The radar memorizes the place latitude and longitude information, and continues displaying the MOB place on a screen. When going to rescue, navigator can take course to the MOB point on screen. <b>Caution:</b> GPS signal must be connected in this function.
Anchor Watch	The anchor monitoring circle is displayed, and the anchor monitoring is performed. Watch for dragging anchor. An alarm will be issued when the ship comes out of the monitoring circle. <b>Caution:</b> GPS signal must be connected in this function.
Vector Length	Set the vector length of own ship and the others. Vectors are displayed as dotted lines.
Radar Trails	Display Radar Trails (Other Ships' Trails). In the initial state, the "Time" trails are displayed in cyan and the "All" the trails are displayed in dark green.
AIS	When received the AIS signal, the data of MMSI of the vessel which has transmitted, latitude, longitude, a direction of movement, speed, rate of turn, etc. is displayed.
TT	A function that automatically tracks the movement of targets, and calculates the course and speed of the targets.
OFF-CENTER	The own ship's position can be moved from the display center to any position within 66% of the display radius. This function is convenient for observing a wide coverage in any direction.
Mark	Uses for putting a mark on the screen. It is also used when deleting unnecessary marks.
Line	Uses for drawing a line on the screen. It is also used to delete unnecessary lines.
Ownship Mark	A mark is put to the position where the own ship is.
Data Off (On)	The information except Radar echo, radar trails, cursor, and some information can be hidden. To display the hidden information again, press [Data On] in the MULTI control menu.



# Chapter 3 ADJUST THE RADAR ECHO

## 3.1 CHANGE RANGE

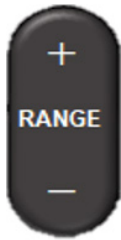

Pressing RANGE button + or - changes the observation range.

- Press the RANGE + button → Extend the range
- Press the RANGE - button → Reduce the range



### 3.2 SENSITIVITY ADJUSTMENT (GAIN)



It is necessary to set an appropriate gain level in order to use the radar exactly. Failure to do so, it is possible to obtain an accurate radar echo.

The sensitivity value is displayed at the lower part of the screen when the GAIN control is turned left or right. Turning the control right increases the value, and turning it left decreases the value.

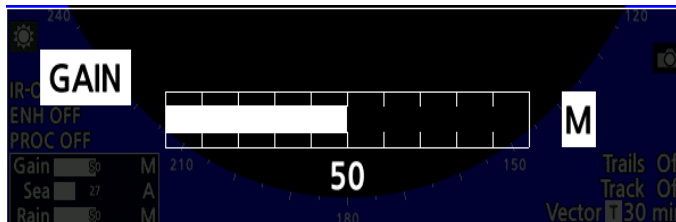

About the GAIN control: please refer to the number 11 in Chapter 2.2.

Examples of the radar echo sensitivity as follows.

Radar echo sensitivity  
Low

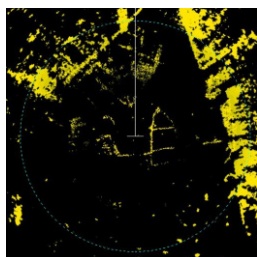

Radar echo sensitivity  
Middle

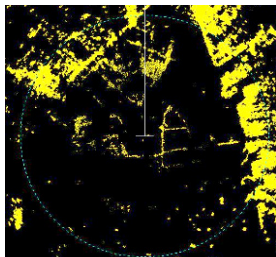

Radar echo sensitivity  
High

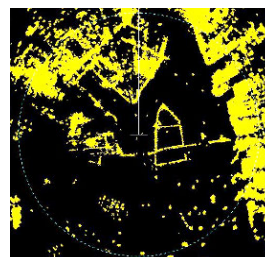

It is important to be note that if you adjust the gain level to maximum, the noise might be also displayed on the screen at the same time.

GAIN set Exceed

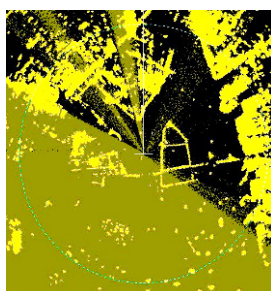

In the case of a fine weather, gain level is set close to the maximum values usually. In the case of a bad weather, such as heavy rain or snow or rough seas, it is necessary to adjust not only the gain level, but also the sea clutter suppression function and rain/snow clutter suppression function. You need to choose an appropriate level, respectively.

#### **⚠ CAUTION**



If sensitivity is set too high, unnecessary signals such as noises in the receiver and false echoes increase to lower target visibility. At the same time, if sensitivity is set too low, detection of targets such as ships and dangerous objects may be hindered. Therefore, sensitivity must always be set to an optimal level.

### 3.3 SEA CLUTTER SUPPRESSION (SEA)



It is necessary to adjust the sea clutter suppression level in order to use the radar exactly. Failure to do so, it is possible to obtain an accurate radar echo.

The sea clutter suppression level is displayed at the lower part of the screen when the SEA control is turned left or right.

Turning the control right increases the value, and turning it left decreases the value.

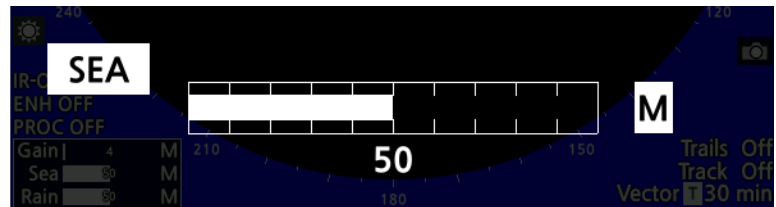

About the SEA control: please refer to the number 12 in Chapter 2.2.

Sea clutter suppression level

LOW

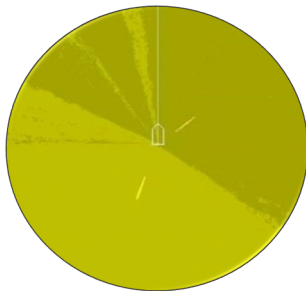

Sea clutter suppression level

Suitable level

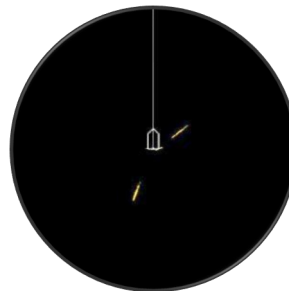

## CAUTION



When using the sea clutter suppression function, never set the suppression level too high canceling out all image noises from the sea surface at close range. Detection of not only echoes from waves but also targets such as other ships or dangerous objects will become inhibited. When using the sea clutter suppression function, make sure to choose the most appropriate image noise suppression level.

### 3.4 RAIN/SNOW CLUTTER SUPPRESSION (RAIN)



It is necessary to adjust the rain/snow clutter suppression level in order to use the radar exactly. Failure to do so, it is impossible to obtain an accurate radar echo.

The rain/snow clutter suppression level is displayed at the lower part of the screen when the RAIN control is turned left or right. Turning the control right increases the value, and turning it left decreases the value.

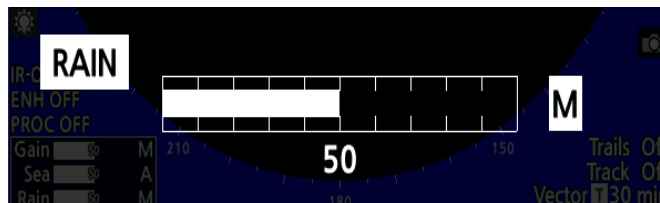

About the RAIN control: please refer to the number 13 in Chapter 2.2.

Rain/Snow clutter suppression level suitable (fine weather)

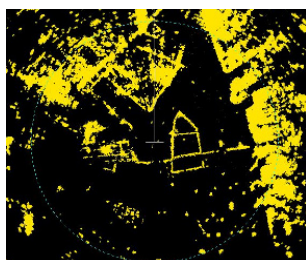

Rain/Snow clutter suppression level excessive (some targets become small)

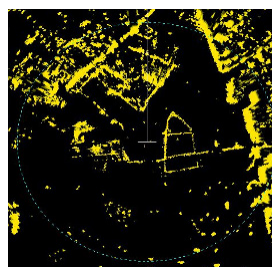

The [RAIN] control can make targets hidden by rain/snow clutter appear on the radar display. Be careful that excessive suppression may cause small targets to be overlooked.

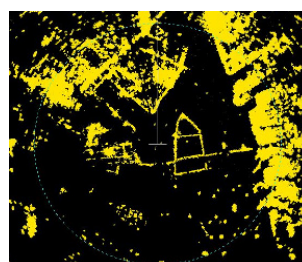

## CAUTION



When using the rain/snow clutter suppression function, never set the suppression level too high canceling out all image noises from the rain or snow at close range. Detection of not only echoes from the rain or snow but also targets such as other ships or dangerous objects will become inhibited. When using the rain/snow clutter suppression function, make sure to choose the most appropriate image noise suppression level.

## 3.5 SCREEN BRILLIANCE (BRILL)

**BRILL**



The brilliance level is displayed at the lower part of the screen when the BRILL control is turned left or right.

Turning the control right increases the value, and turning it left decreases the value.

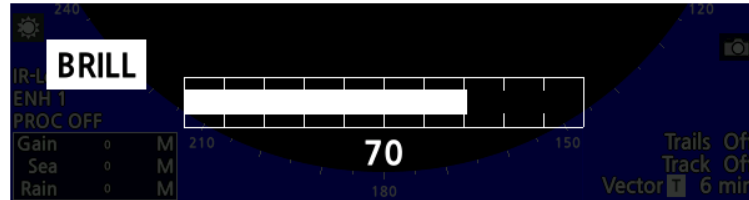

About the BRILL control: please refer to the number 15 in Chapter 2.2.

### \* \* \* \* FOR REFERENCE \* \* \* \*

In order to obtain an accurate radar echo, sea clutter suppression adjustment and gain adjustment are essential.

**RAIN:** Normally is set to "0." But in the case of rain or snow, you need use the rain clutter suppression function to remove the noise appearing on the screen.

**GAIN:** Adjust the GAIN to increase receiving sensitivity, then the radar observation range can be extended. If the sensitivity is set too high, the receiver noise is increase, and the contrast between the targets and the background video is reduced. As a result, the targets become obscure on the radar display. To observe densely crowded targets or short-range targets, adjust the GAIN to reduce the sensitivity so that the targets are easy to observe. However, be careful not to overlook important small targets.

**SEA:** SEA clutter suppression function can suppress the near range clutter noise. If the suitable adjustment is done, you can observe a clear target from short range to long range.

When the automatic mode is selected for the rain/snow clutter suppression function, the sea clutter suppression function is switched to the manual mode. The sea clutter suppression function (AUTO) and the rain/snow suppression function (AUTO) cannot be selected at the same time. In addition, Please adjust the video in function (MANUAL) usually. Please attempt the function (AUTO) when the video adjustment of short-range cannot adjust by the bad weather.

#### < ACTUAL OPERATION >

Set RAIN clutter suppression level to 0.

(1) Set RANGE to more than 6NM, and determine the target in the distance. The target location is far, and the targets as far possible can barely display is preferable. Set GAIN in order to observe the target clearly.

(2) Change RANGE to 0.5NM, and set SEA clutter suppression level to observe the near target clearly. If you reduce the GAIN at this time, the target that was able to display at (1) will be not able to display, please note on the relation between the long range.

(3) Since the rain/snow clutter suppression function also has the effect of suppressing sea clutter, the suppression efficiency improves when using with the [SEA] control. In general, RAIN clutter suppression level is set to "0." But if you encounter a bad weather, set RAIN clutter suppression level to achieve better observation state.

# Chapter 4 VRM AND EBL FUNCTION

## 4.1 OPERATION OF VRM, EBL

- VRM:** After pressing the VRM button, the size of the ring can be changed by turning the MULTI control to the left or right. The VRM can be operated even by pressing the MULTI control and selecting VRM. The distance to the ring is displayed on the screen.
- Erase VRM:** Select the VRM to be erased by pressing the VRM button shortly, and erase it by long pressing the VRM button. Alternatively, press the MULTI control, select VRM, and long press the MULTI control to erase.
- EBL:** After pressing the EBL button, the EBL can be moved by turning the MULTI control to the left or right. The EBL can be operated even by pressing the MULTI control and selecting EBL. The direction of the line is displayed on the screen.
- Erase EBL:** Select the EBL to be erased by pressing the EBL button shortly, and erase it by long pressing the EBL button. Alternatively, press the MULTI control, select EBL, and long press the MULTI control to erase.

**Note:**

If the VRM · EBL does not appear,  
 There is a possibility that has been set the setting of the display color of PPI: black and EBL / VRM: black. See 8.9.2 COLOR SETTINGS, and check.

## 4.2 EXAMPLE OF VRM FUNCTION

Example: VRM function

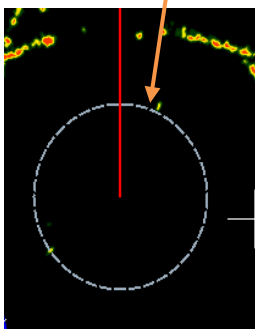

Range from own ship to the target is displayed.

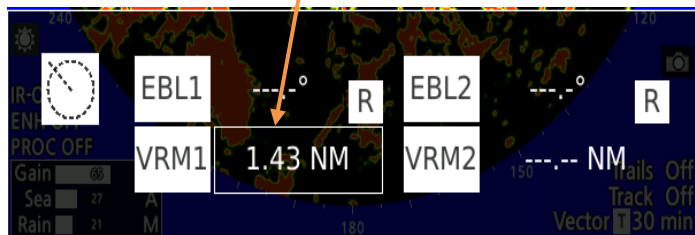

How to erase the menu dialog:

- press the CLR button or
- press the MULTI control. (Also serve for deciding VRM)

### How to change the VRM

Press the VRM button, and turn the MULTI control left or right to change the ring size.

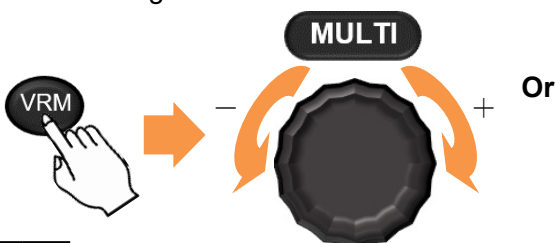

Press the MULTI control, select VRM1/2 and turn the MULTI control left or right to change the ring size. Press the MULTI, then set the VRM.

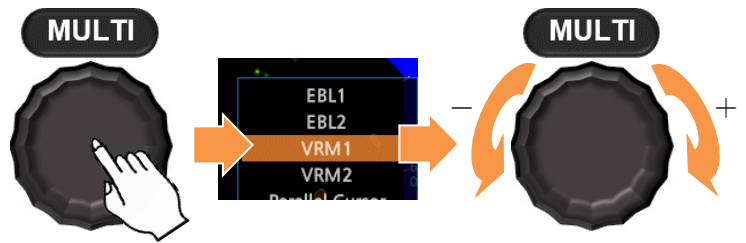

### 4.3 EXAMPLE OF EBL FUNCTION

Example: EBL function.

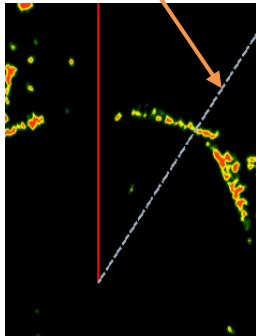

Target bearing is displayed.

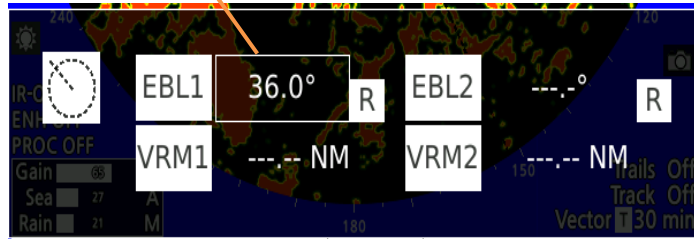

How to erase the menu dialog:

press the CLR button or

press the MULTI control. (Also serve for deciding EBL)

Press the MULTI control, select EBL1/2 and turn the MULTI control left or right to change the EBL direction.

Press the MULTI, then set the EBL.

#### How to change the EBL

Press the EBL button, and turn the MULTI control left or right to change the EBL direction.



**\* \* \* \* FOR REFERENCE \* \* \* \***

**ABOUT EBL/VRM FUNCTION**

The target direction and range information can be measured by EBL and VRM function.

**Bearing measurement method:**

- (1) The RELATIVE BEARING which is measured from own ship heading line.
- (2) The TRUE BEARING which is measured from the north line.

Certainly, TRUE BEARING is calculated by RELATIVE BEARING and GYRO BEARING.

So, to calculate the TRUE BEARING is necessary a signal from GYRO or GPS compasses.

In case of no external bearing signal, display only RELATIVE BEARING mode.

Target tracking function (TT) and display AIS symbol is necessary the GYRO or GPS compass signal.

When GYRO or GPS compass signal is received, normally azimuth is measured from the north (TRUE AZIMUTH).

This radar scanner has a microwave BEAM WIDTH is about 4 degrees (NKE-2043), 2 degrees (NKE-2063A), 1.9 degrees (NKE-2103-4) or 1.2 degrees (NKE-2103-6).

So every target echo has more than 4 degrees, 2 degrees, 1.9 degrees or 1.2 degrees width for bearing direction.

For above reason, in case of read out the target azimuth, you need set EBL line to the center of the target echo.

RANGE of target echo in any azimuth can be measured by the VRM function from own ship.

Target echo size is proportion to pulse width which transmitted from own ship.

In case of MEASURE SHORT RANGE ECHO using VRM, you need set ring to the echo's nearest point from own ship.

At that point, you can get the correct RANGE for any pulse width.

**Floating:**

The base point of EBL/VRM can be set other than own ship position. Refer to "5.18.1 EBL."

# Chapter 5 VARIOUS FUNCTIONS

## 5.1 PARALLEL CURSOR FUNCTION

Parallel Cursor is straight lines at equal interval that are displayed on the screen.

By using Parallel Cursor lines, complicated measurement is enabled relating to the bearing and the range by using the own ship's position as the reference point.

### Adjustment of Bearing/Interval

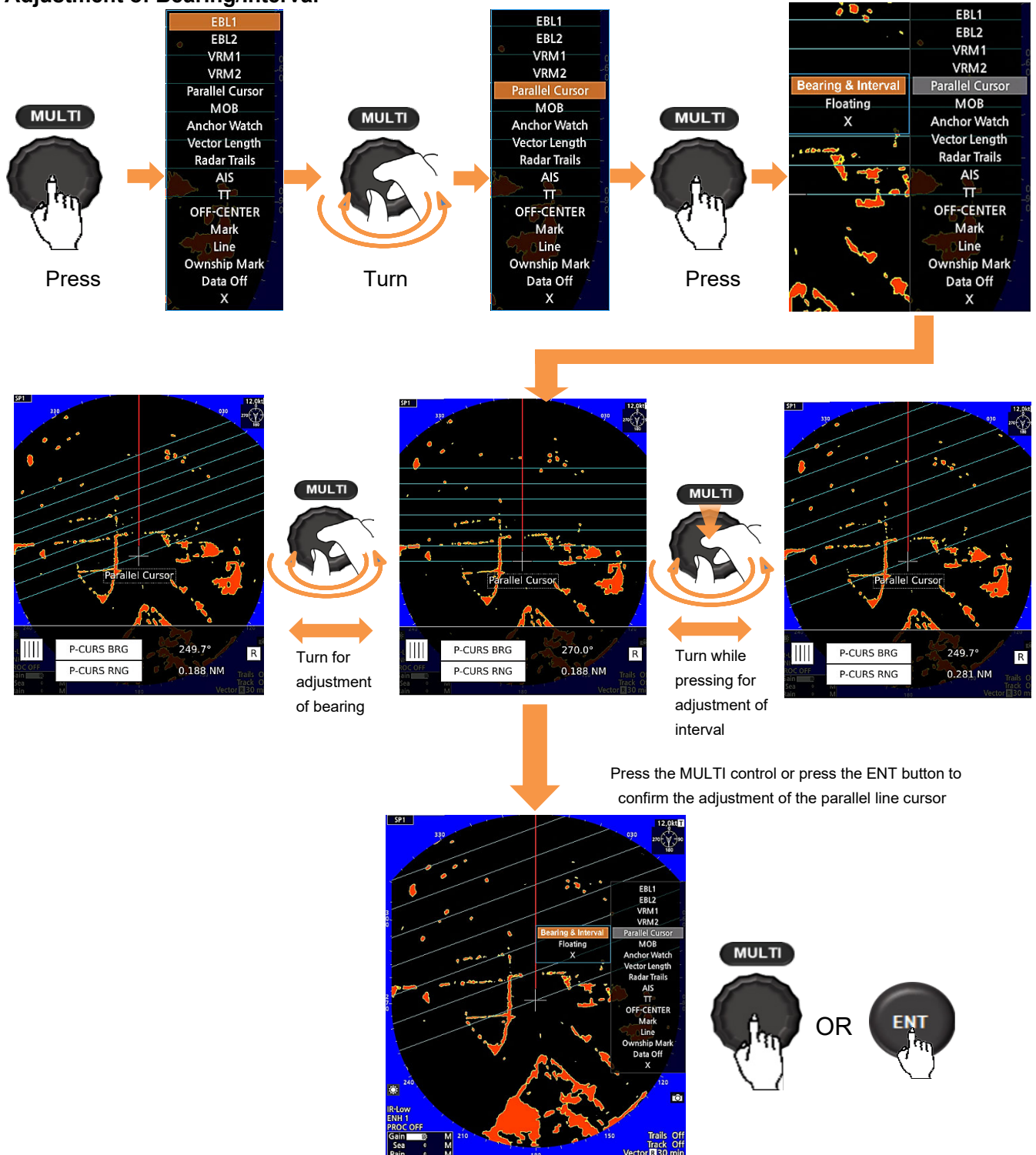



## Adjustment of Floating

By using the Floating, you can move the center of the Parallel Cursor from your ship position to any point.

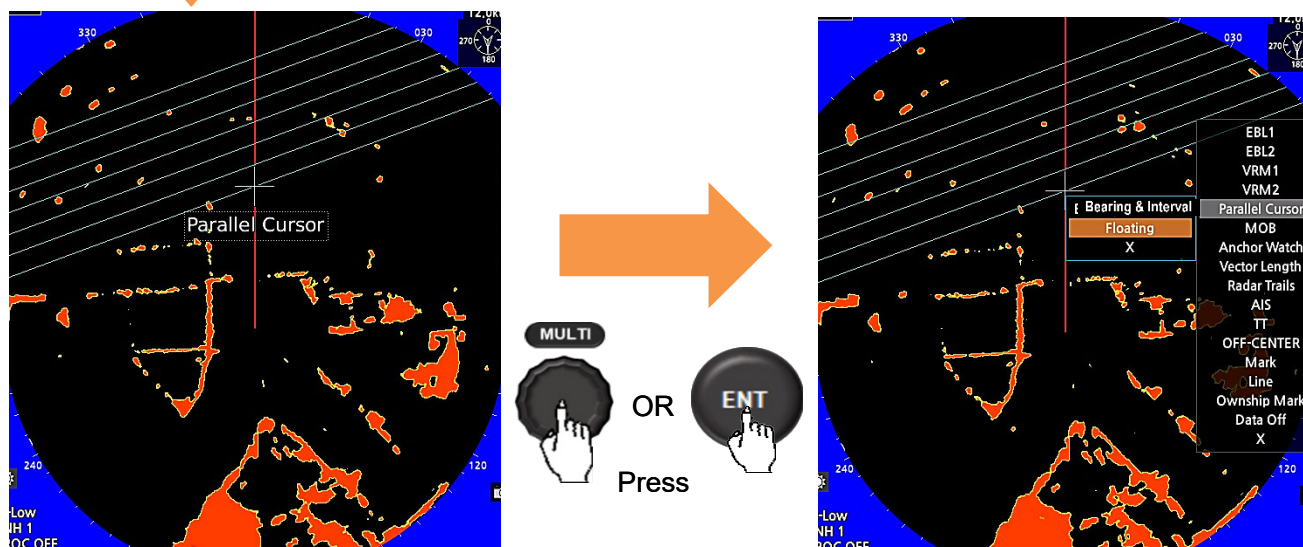
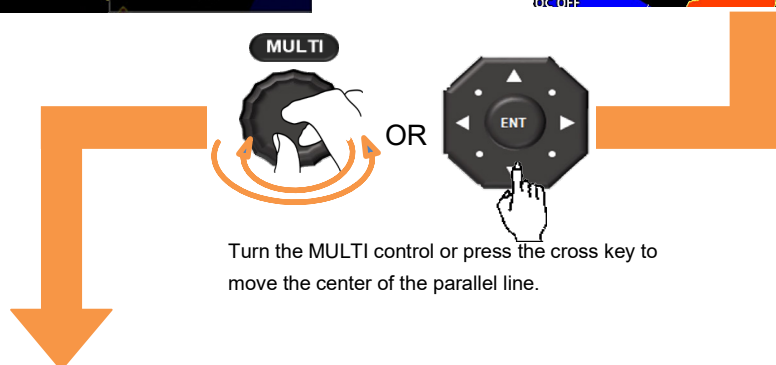
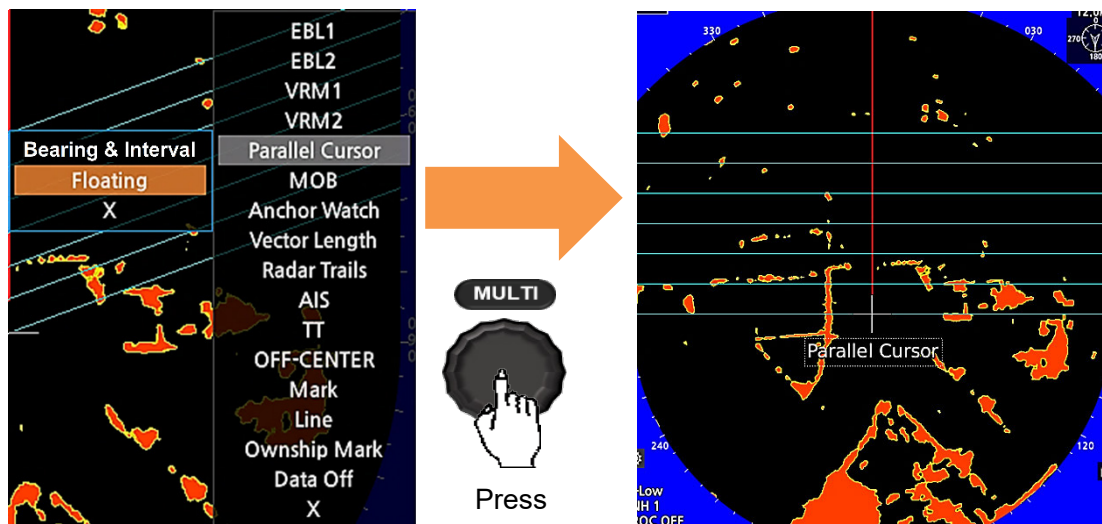

Press the MULTI control or press the ENT button to set the center point at the moved position.

### Reference:

The floating position of the Parallel Cursor starting point can be fixed on the radar display or at specific angle.

Floating function must be turned on to use floating.

For details of settings, see "5.18.2."

### Hide Parallel Cursors

Select "Parallel Cursor" on the MULTI control menu, and long press the MULTI control.

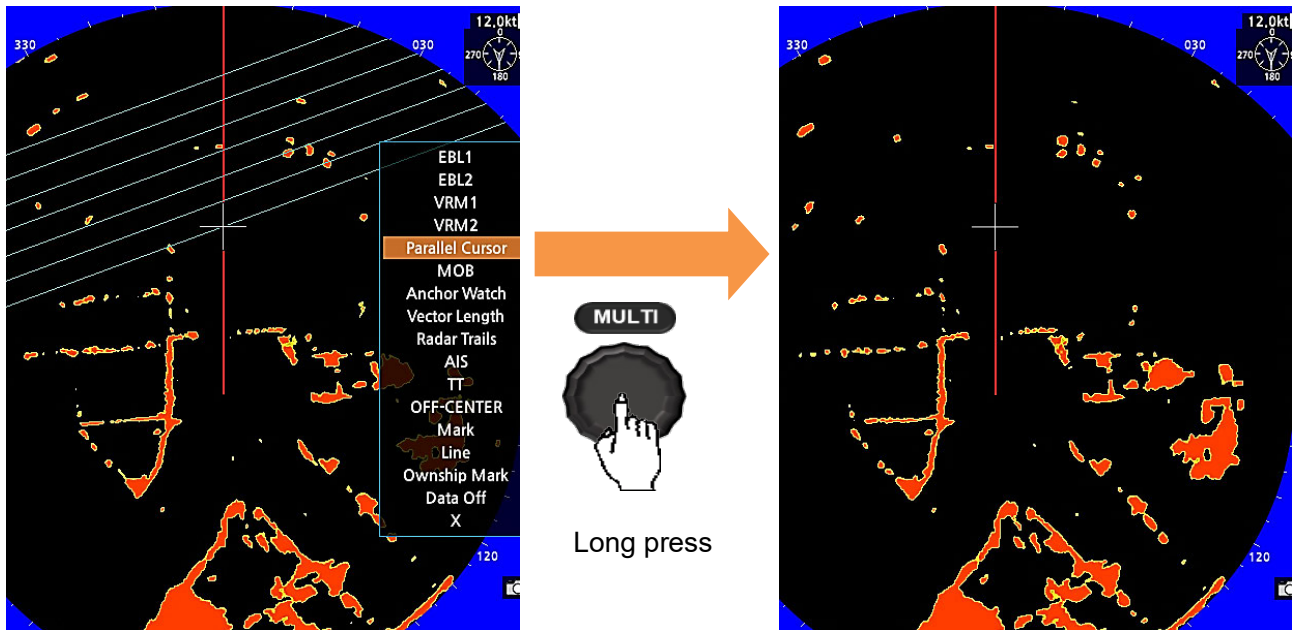

## 5.2 MOB FUNCTION (MAN OVERBOARD)

MOB is the mark of a person or an object overboard. If someone or something falls overboard, set MOB to memorize the latitude/longitude of the location and display the mark. Also, a straight line from the own ship to the mark is displayed.

### Start MOB Function

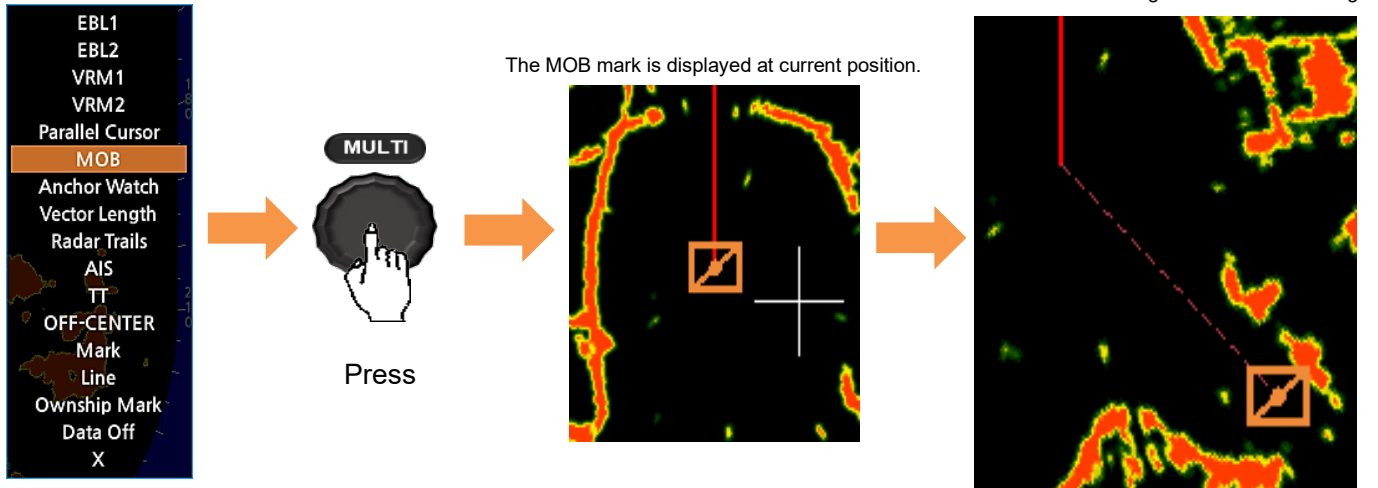

### Reference:

If running MOB function, displays icon  on left of screen.

The bearing, range, and TTG (time to go) to the MOB position are displayed at the bottom of the screen as follows.

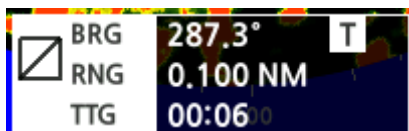

### Finish MOB Function

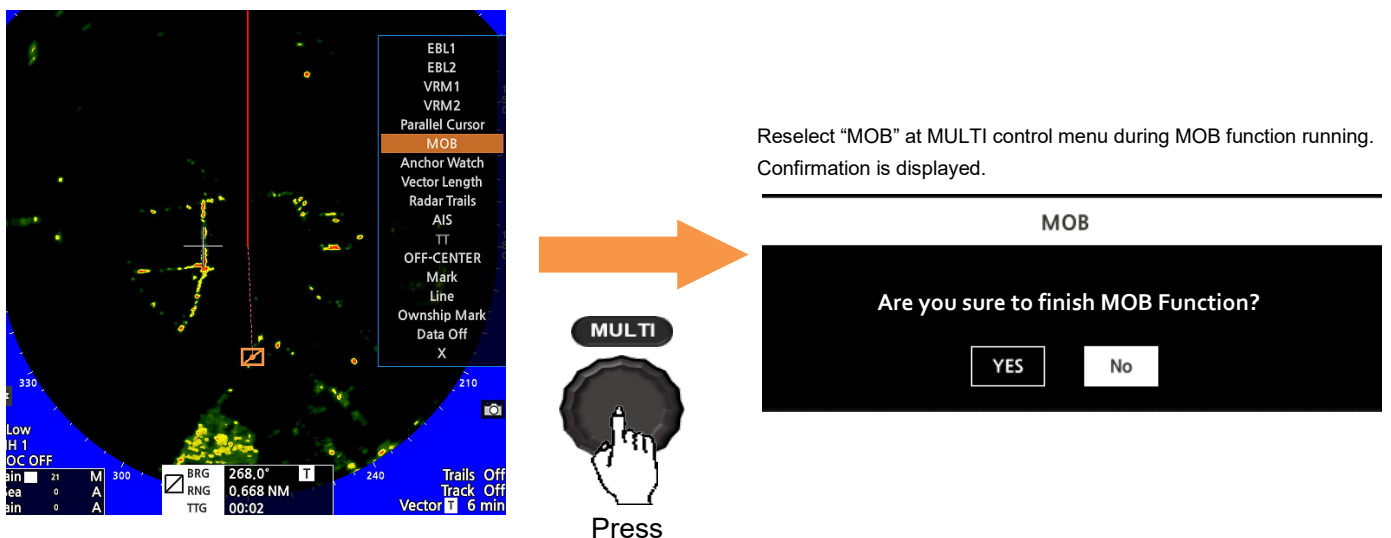

## 5.3 ANCHOR WATCH FUNCTION

Anchor Watch is a function that sets a circular dragging anchor monitoring area around the own ship and realizes safe voyage by generating an anchor alarm when a part of the outline of the own ship exceeded the monitoring area.

### Start Anchor Watch function

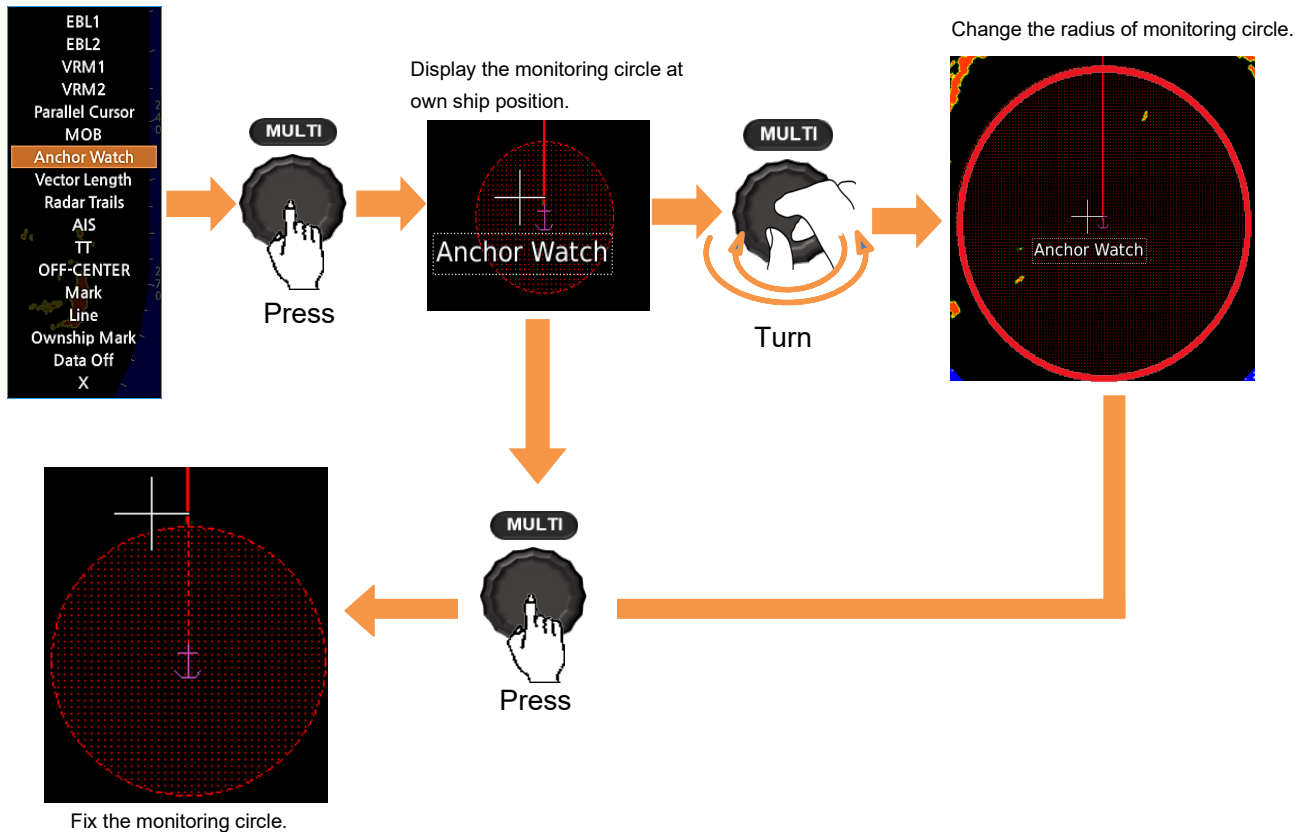

### In action Anchor Watch

The following screen will be displayed during the anchor watching.

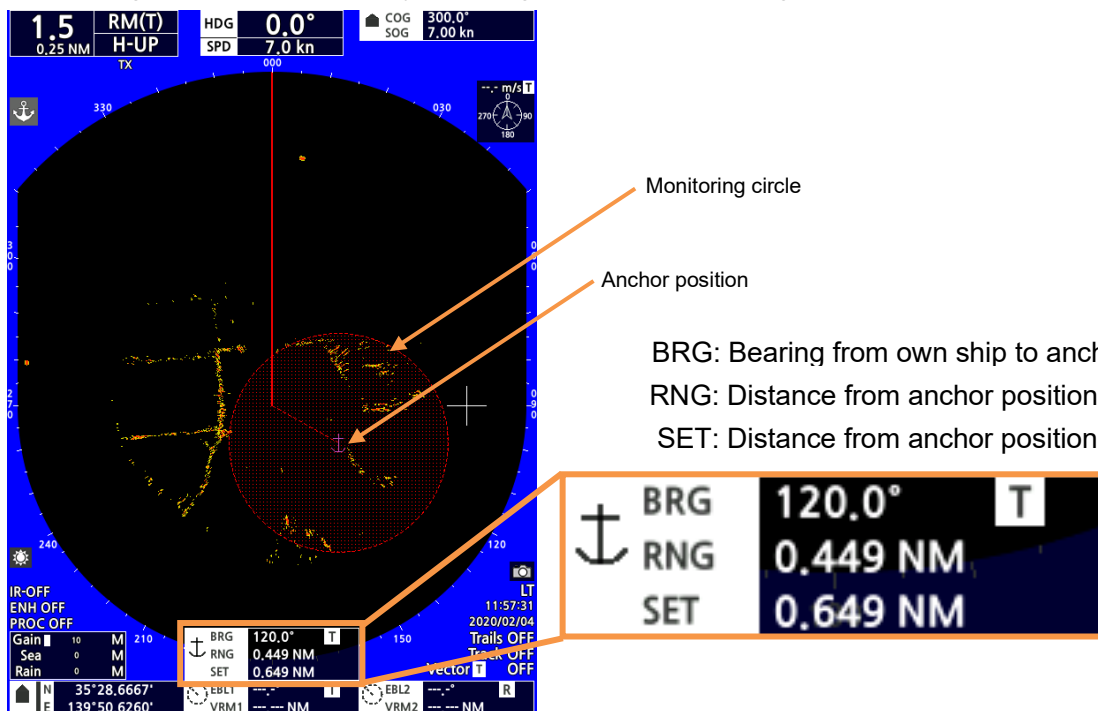

**Reference:**

If running Anchor Watch, display icon  on left of screen.

**Finish Anchor Watch function**

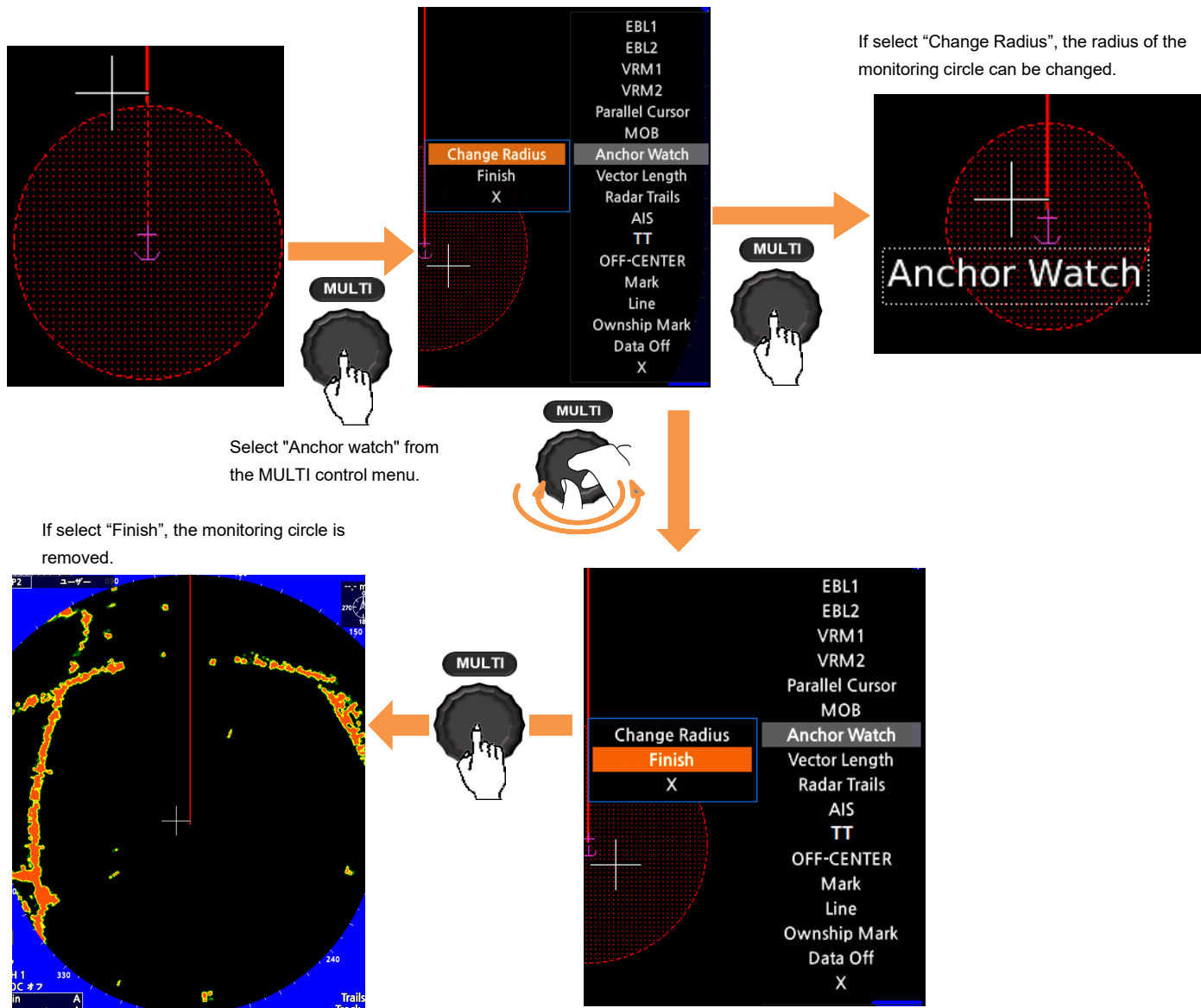

## 5.4 VECTOR LENGTH

The Vector Length is set in min in the range from 1 min to 60 min.  
 For vector mode of settings, see "5.21 VECTOR."

### Settings Vector Length

By turning the MULTI control in the "Vector Length" menu, you can select the vector length

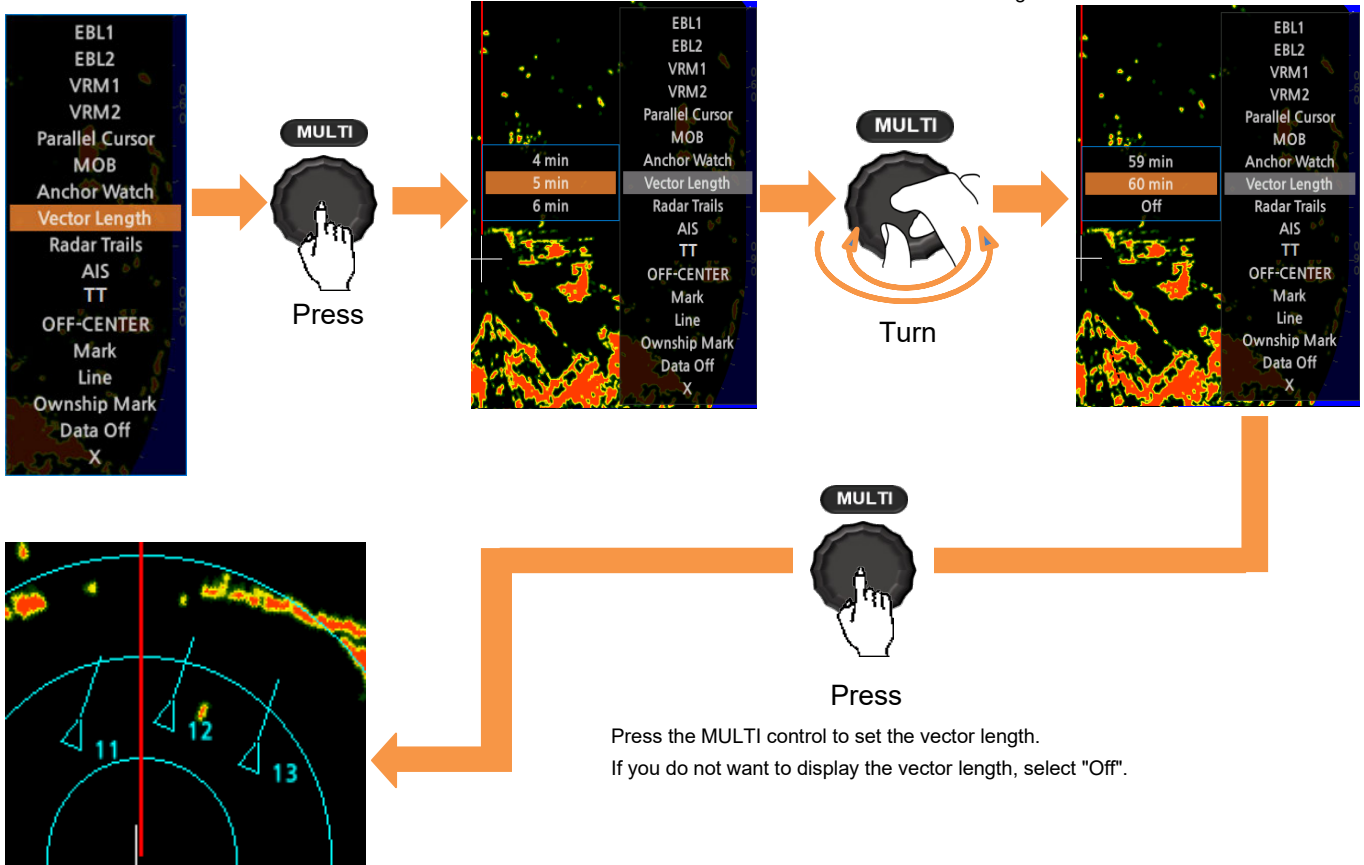

### Reference:

The following figure shows an example in which the Vector Length is set to 6 min, and the tip of the vector represents the target's position expected to reach 6 minutes later.

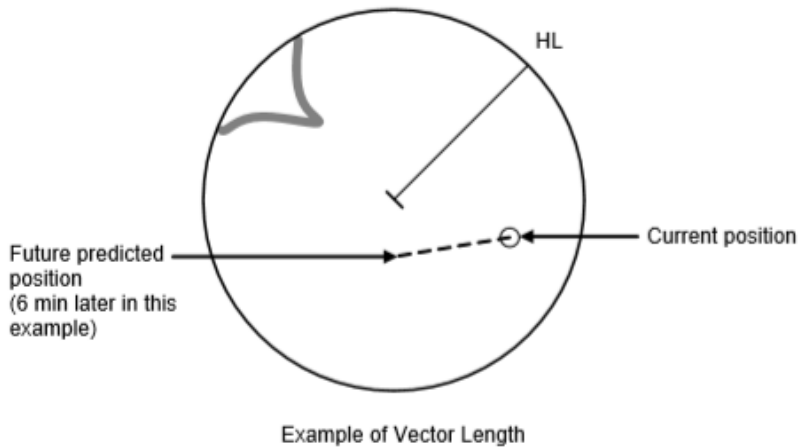

## 5.5 RADAR TRAILS

Radar Trails is can be used to figure out how well you can navigate an obstacle and how well you can keep the bearing that have set for your ship.

The echo trail is displayed on the radar display screen so you can easily assess visually what is going on.

### 5.5.1 SETUP THE RADAR TRAILS INTERVAL

You can be selected in the range of Trail Length set by Max Interval.

For Max Length of settings, see "8.2 TRAILS."

- Short : OFF/15sec/30sec/1min/2min/3min/4min/5min/6min/10min/15min/Continuous  
 Middle : OFF/30sec/1min/2min/3min/4min/5min/6min/10min/15min/30min/Continuous  
 Long : OFF/1min/2min/3min/4min/5min/6min/10min/15min/30min/1hour/Continuous  
 Super Long : OFF/30min/1hour/2hour/3hour/4hour/5hour/6hour/10hour/12hour/24hour/Continuous

#### Settings Radar Trails interval

By turning the MULTI control in the Radar Trails menu, you can change the radar trails

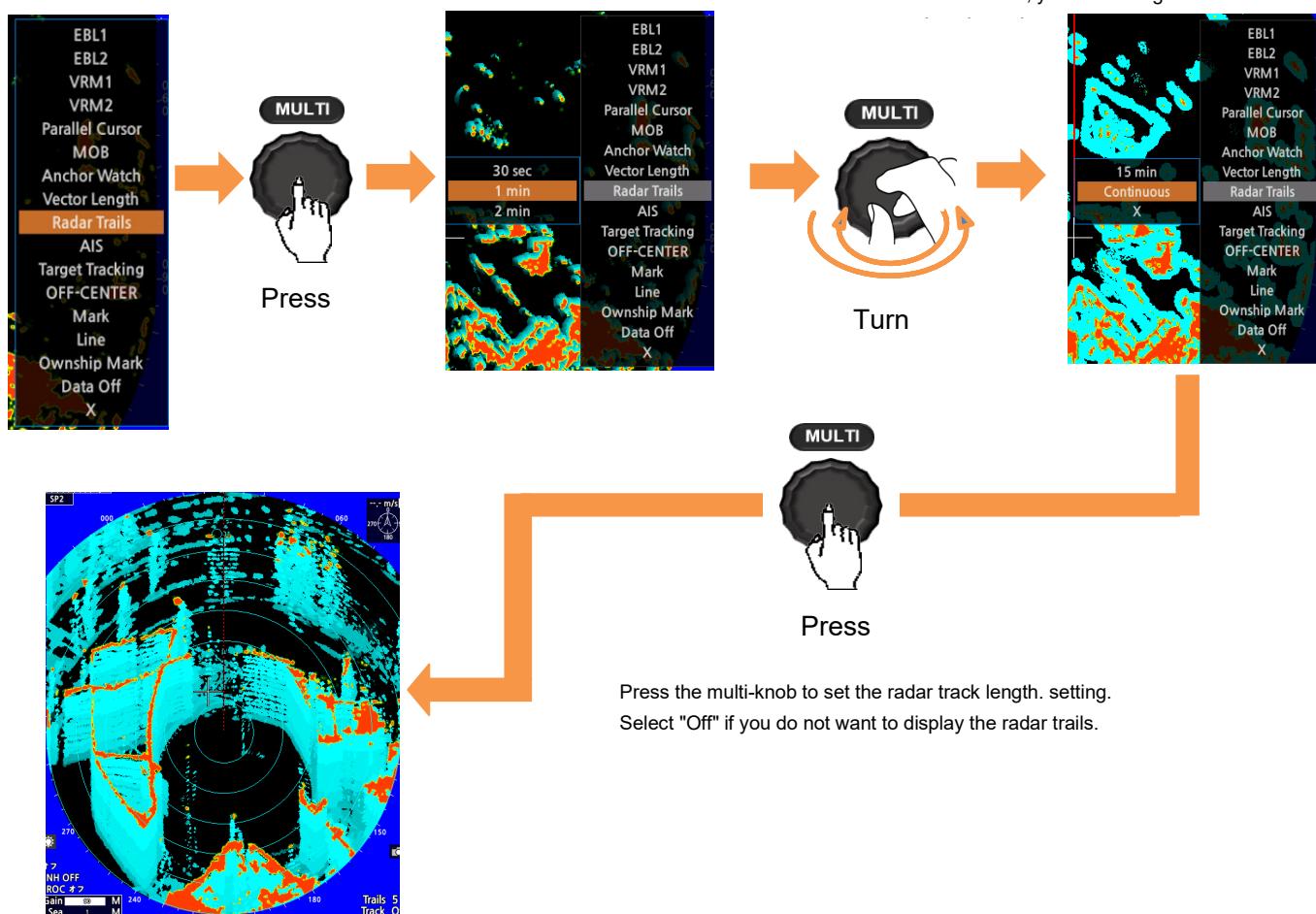

## 5.6 AIS OPERATIONS

AIS is shows the target's information on the radar display, using other ship's information sent out from the AIS unit. Furthermore, the AIS displaying function of this unit does not conform to IE C62388 / 62288 in operation and symbol display. Thus, it is a simplified AIS displaying function.

**Reference:**

To use this function, ship's heading, position and AIS information are required.

For AIS function of settings, see "5.24 AIS/TT."

The specified target data is displayed.

BRG and RNG shows the relative positional information which is observed from the own ship. COG and SOG shows ground speed and ground course of the target. Position information is measured through the GPS which is equipped to the ship.

The target data will remain on the radar display until the target is lost, or until another target is designated.

The displayed AIS data can be closed by press the CLR button.

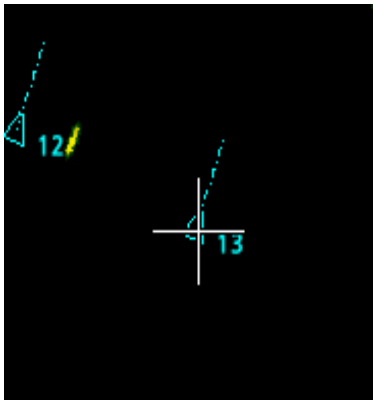

Move the cross cursor to the AIS for which you want to check information.

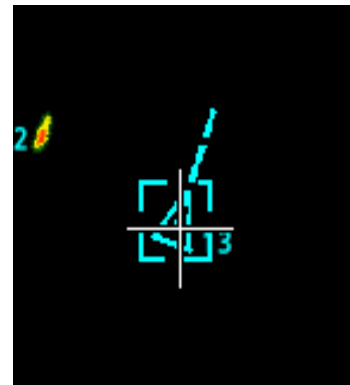
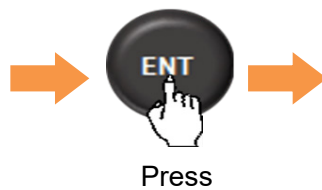

Information on the selected AIS is displayed at the bottom of the screen.

<b>AIS NO.100</b>		CPA: 0.917 NM	
JRCMARU		TCPA: 2 min	
BRG: 157.9°		RNG: 0.994 NM	
HDG: 45.0°	MMSI: 377470000(VC)		
COG: 45.0°	Call Sign: JRC0001		
SOG: 10.00 kn	Type: (category Z)		
ROT: 1.1°/min	B/L: 300/50		
Draft: 8.0m	under way using e...		

AIS No.	CPA	Closest point of approach.	
Ship's name	TCPA:	Time to CPA.	
BRG:	Target bearing from own ship direction.	RNG:	Target range from own ship position.
HDG:	The ship's heading.	MMSI:	The ship's MMSI (Country).
COG:	The ship's course over ground.	Call Sign	The ship's call sign.
SOG:	The ship's speed over ground.	Type	The ship's ship type.
ROT:	The ship's rotation.	B/L:	Length / The ship's beam.
Draft:	The ship's draft.	The ship's navigation status	



Display AIS ship name on the screen using MULTI control menu.

### Ship name display

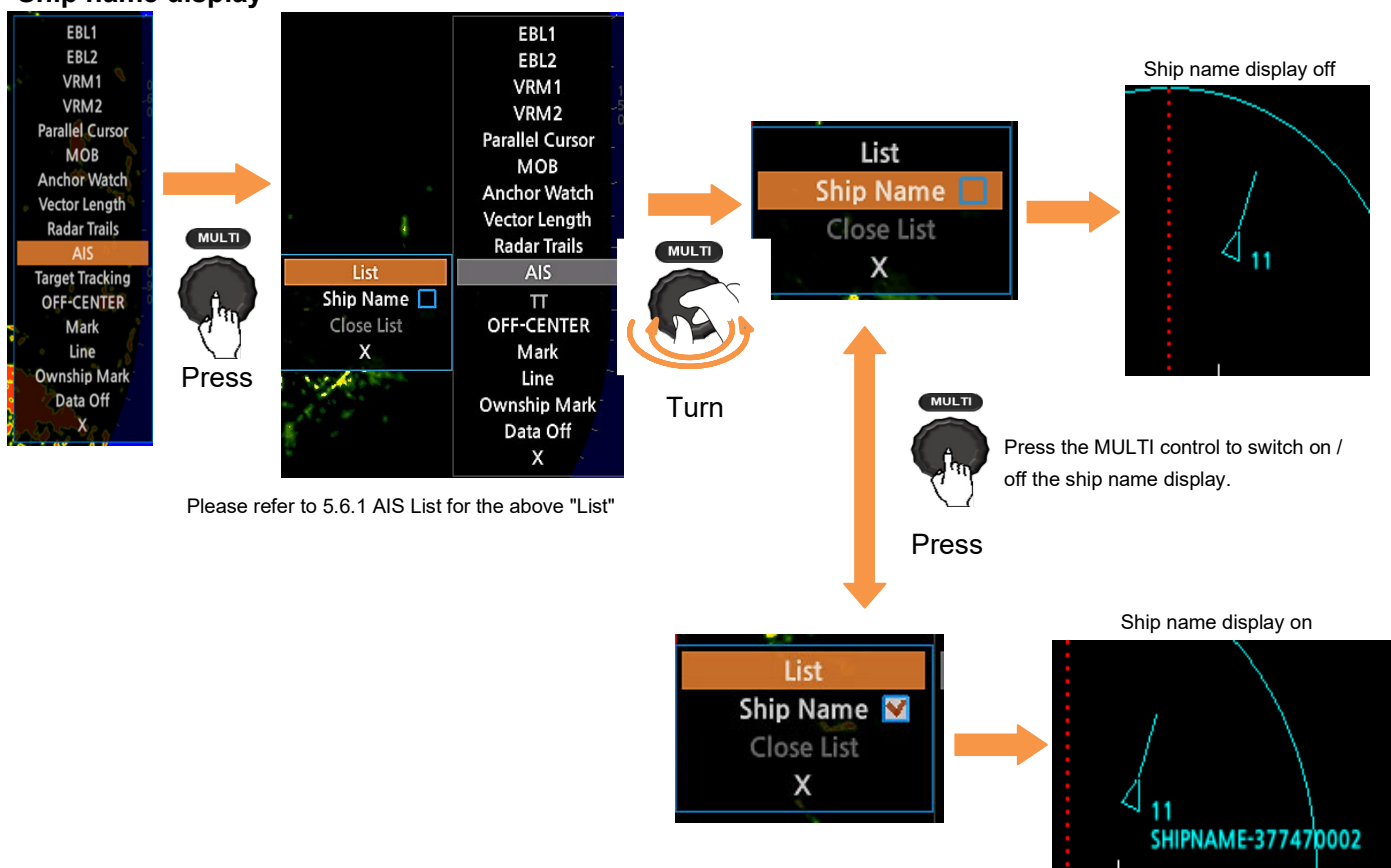

### 5.6.1 AIS LIST

The list of displaying AIS can be checked.

#### Procedures

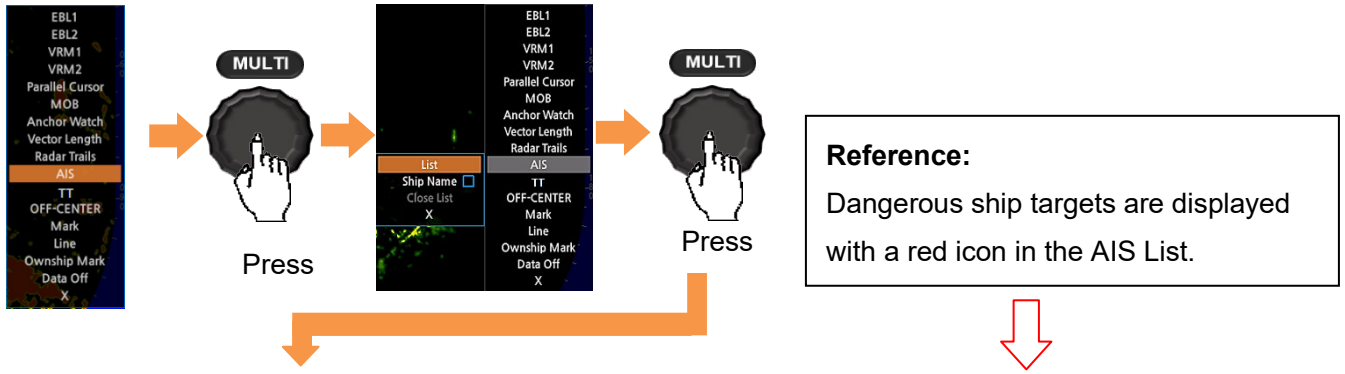

AIS List			
100	JRC0010	377470009 SHIPNAME-J	AIS NO.101
101	JRC0009	377470008 SHIPNAME-I	CPA: --- NM TCPA: --- min
102	JRC0008	377470007 SHIPNAME-H	BRG: 56.6° RNG: 1.031 NM
103	JRC0007	377470006 SHIPNAME-G	HDG: 10.0° MMSI: 377470008(V)
104	JRC0001	377470000 SHIPNAME-A	COG: 10.0° Call Sign: JRC0009
105	JRC0006	377470005 SHIPNAME-F	SOG: 1.20 kn Type: HSC(-)
			ROT: 0.0°/min B/L: 320/60
			Draft: 10.0m under way using e...

AIS List			
100	JRC0001	377470000 JRCMARU	AIS NO.100
101	JRC0010	377470009 SHIPNAME-J	CPA: 0.913 NM TCPA: 0 min
102	JRC0009	377470008 SHIPNAME-I	BRG: 138.4° RNG: 0.915 NM
103	JRC0008	377470007 SHIPNAME-H	HDG: 45.0° MMSI: 377470000(V)
104	JRC0002	377470001 SHIPNAME-D	COG: 45.0° Call Sign: JRC0001
105	JRC0007	377470006 SHIPNAME-G	SOG: 10.00 kn Type: (category Z)
			ROT: 1.1°/min B/L: 300/50
			Draft: 8.0m under way using e...

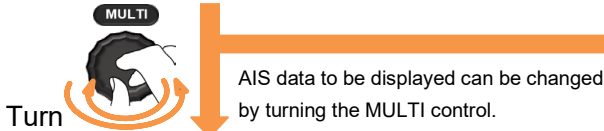

AIS List			
100	JRC0010	377470009 SHIPNAME-J	AIS NO.101
101	JRC0009	377470008 SHIPNAME-I	CPA: --- NM TCPA: --- min
102	JRC0008	377470007 SHIPNAME-H	BRG: 56.6° RNG: 1.031 NM
103	JRC0007	377470006 SHIPNAME-G	HDG: 10.0° MMSI: 377470008(V)
104	JRC0001	377470000 SHIPNAME-A	COG: 10.0° Call Sign: JRC0009
105	JRC0006	377470005 SHIPNAME-F	SOG: 1.20 kn Type: HSC(-)
			ROT: 0.0°/min B/L: 320/60
			Draft: 10.0m under way using e...

AIS List			
105	JRC0006	377470005 SHIPNAME-F	OWN SHIP
106	JRC0002	377470001 SHIPNAME-D	TOMOYASU
107	JRC0005	377470004 SHIPNAME-E	CPA: --- NM TCPA: --- min
108	JRC0003	377470002 SHIPNAME-C	HDG: 1.0° MMSI: 636090412(L)
109	JRC0004	377470003 SHIPNAME-B	COG: 20.0° Call Sign: JK2ULN
OWN	JK2ULN	636090412 TOMOYASU	SOG: 5.00 kn Type: (category Z)
			ROT: 4.5°/min B/L: 380/70
			Draft: 4.0m aground

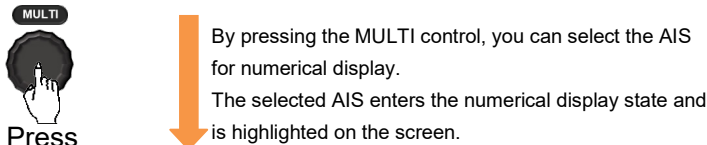

Own ship information is displayed at the bottom of the AIS list.

AIS NO.100			
		SHIPNAME-J	CPA: --- NM TCPA: --- min
		BRG: 61.1°	RNG: 0.958 NM
		HDG: 10.0° MMSI: 377470009(V)	
		COG: 10.0° Call Sign: JRC0010	
		SOG: 1.20 kn Type: other()	
		ROT: 0.0°/min B/L: 300/35	
		Draft: 20.0m	under way using e...



AIS List			
100	JRC0010	377470009 SHIPNAME-J	AIS NO.100
101	JRC0009	377470008 SHIPNAME-I	CPA: --- NM TCPA: --- min
102	JRC0008	377470007 SHIPNAME-H	BRG: 61.1° RNG: 0.958 NM
103	JRC0007	377470006 SHIPNAME-G	HDG: 10.0° MMSI: 377470009(V)
104	JRC0001	377470000 SHIPNAME-A	COG: 10.0° Call Sign: JRC0010
105	JRC0006	377470005 SHIPNAME-F	SOG: 1.20 kn Type: other()
			ROT: 0.0°/min B/L: 300/35
			Draft: 20.0m under way using e...

Press the MULTI control again to cancel the selection.

Turn

AIS List			
106	JRC0002	377470001 SHIPNAME-D	List Close
107	JRC0005	377470004 SHIPNAME-B	
108	JRC0003	377470002 SHIPNAME-C	
109	JRC0004	377470003 SHIPNAME-E	
OWN	JK2ULN	636090412 TOMOYASU	

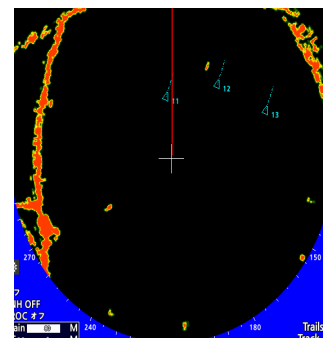
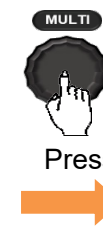





When the focus is on AIS LIST Close and the MULTI control is pressed, the display of the AIS list ends. Even if you exit the AIS List, the AIS information in the numerical display state will be displayed continuously.

**Reference:****Symbols displayed in the AIS list**

#	Numeric display Information is displayed even if the list is closed (only one ship)
\$	Destination ship
*	Retrieved Vessel

Destination ships and Retrieved Vessels can be set in Main Menu  
Refer to 5.24 AIS/TT.

**Symbols of AIS displayed on the screen**

	Numeric display
	Retrieved Vessel
	Destination ship
	AIS SART

## 5.7 TT OPERATIONS

To use the target tracking function, direction signal and GPS signal information are required. The target tracking function calculates the course and speed of a target by automatically tracking the target's move. If there is a possibility of a collision, an alarm can be sounded.

Furthermore, the target tracking function of this unit does not conform to IEC 62388 / 62288 in operation and symbol display. Thus, It is a simplified target tracking function.

### Note:

There are the following limitations on use of the target acquisition and target tracking functions.

[I] Resolution between adjacent targets and swapping during automatic target tracking

Depending on the particular distance and echo size, resolution between adjacent targets during automatic target tracking usually ranges somewhere between 0.03 to 0.05 NM. If multiple targets approach each other, resolution will become about 0.05 NM and this may cause the system to regard them as one target and thus to swap them or lose part of them. Such swapping or loss of targets may also occur if the picture of the target being tracked is affected by rain/snow clutter or sea clutter or moves very close to land.

[II] Intensity of echoes and the target tracking function

The intensity of echoes and the tracking function have a correlation ship, and thus the target will be lost if no echoes are detected during 10 scans in succession.

If a lost target exists, therefore, radar gain must be increased to support detection of the target. If, however, radar gain is increased too significantly, sea clutter or other noise may be erroneously detected and tracked as a target, and resultingly, a false alarm may be issued. To execute accurate tracking, it becomes necessary to appropriately adjust the [GAIN], [SEA] and [RAIN] controls of the radar so that the target to be acquired and tracked is clearly displayed on the radar display.

Inappropriate settings of these adjustments reduce the reliability / accuracy of automatic tracking.



## CAUTION



**Use the radar only as a navigation aid. The final navigation decision must always be made by the operator him/herself. Making the final navigation decision based only on the radar display may cause accidents such as collisions or running aground.**



**Use the target tracking function (TT) only as a navigation aid. The final navigation decision must always be made by the operator him/herself. Making the final navigation decision based only on the target tracking function (TT) information may cause accidents.**

**The target tracking function (TT) information such as vector, target numerical data, and alarms may contain some errors. Also, targets that are not detected by the radar cannot be acquired or tracked.**

**Making the final navigation decision based only on the radar display may cause accidents such as collisions or running aground.**

## TT information display

If select TT symbol on PPI, the TT numerical information is displayed bottom of screen.

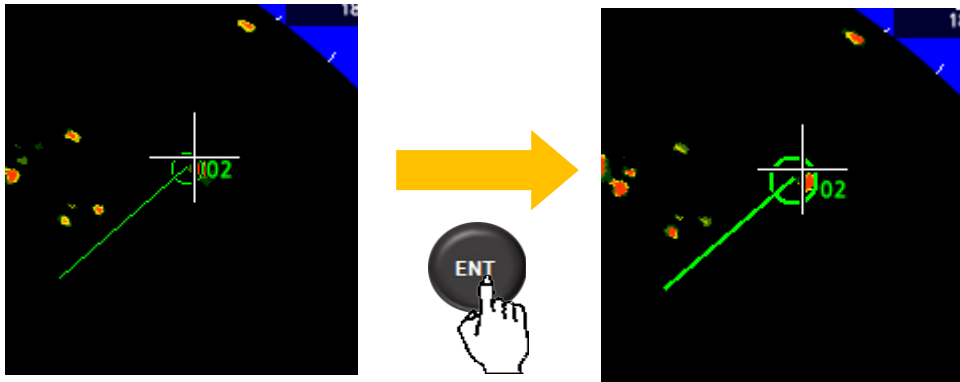

Move the cursor on TT and press the ENT button.

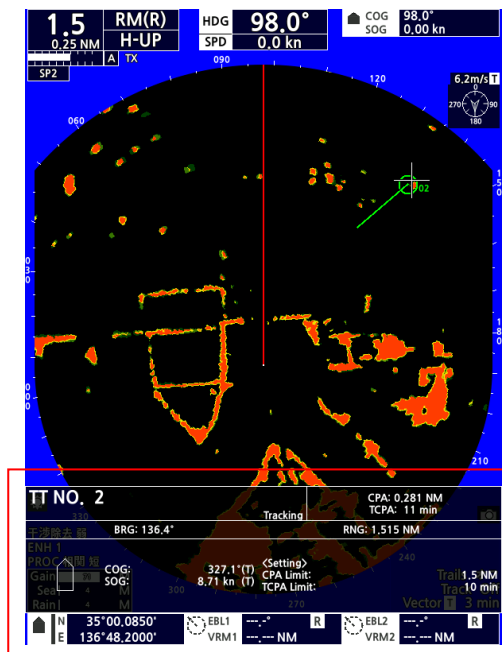

TT No.	Status	CPA:	Closest point of approach.
		TCPA:	Time to CPA.
BRG:	Target bearing from own ship.	RNG:	Target range from own ship position.
COG:	Course over ground.	CPA Limit:	CPA setting value (see 5.24.2).
SOG:	Speed over ground.	TCPA Limit:	TCPA setting value (see 5.24.3).

Reference :

The following status is shown in "Status."

Acquiring	Initial acquiring.
Tracking	Tracking target that is not a dangerous or lost.
Danger	Dangerous ship. The ship icon at the bottom left of the information screen is displayed in red.
Lost	Lost tracked target.

TT List operation

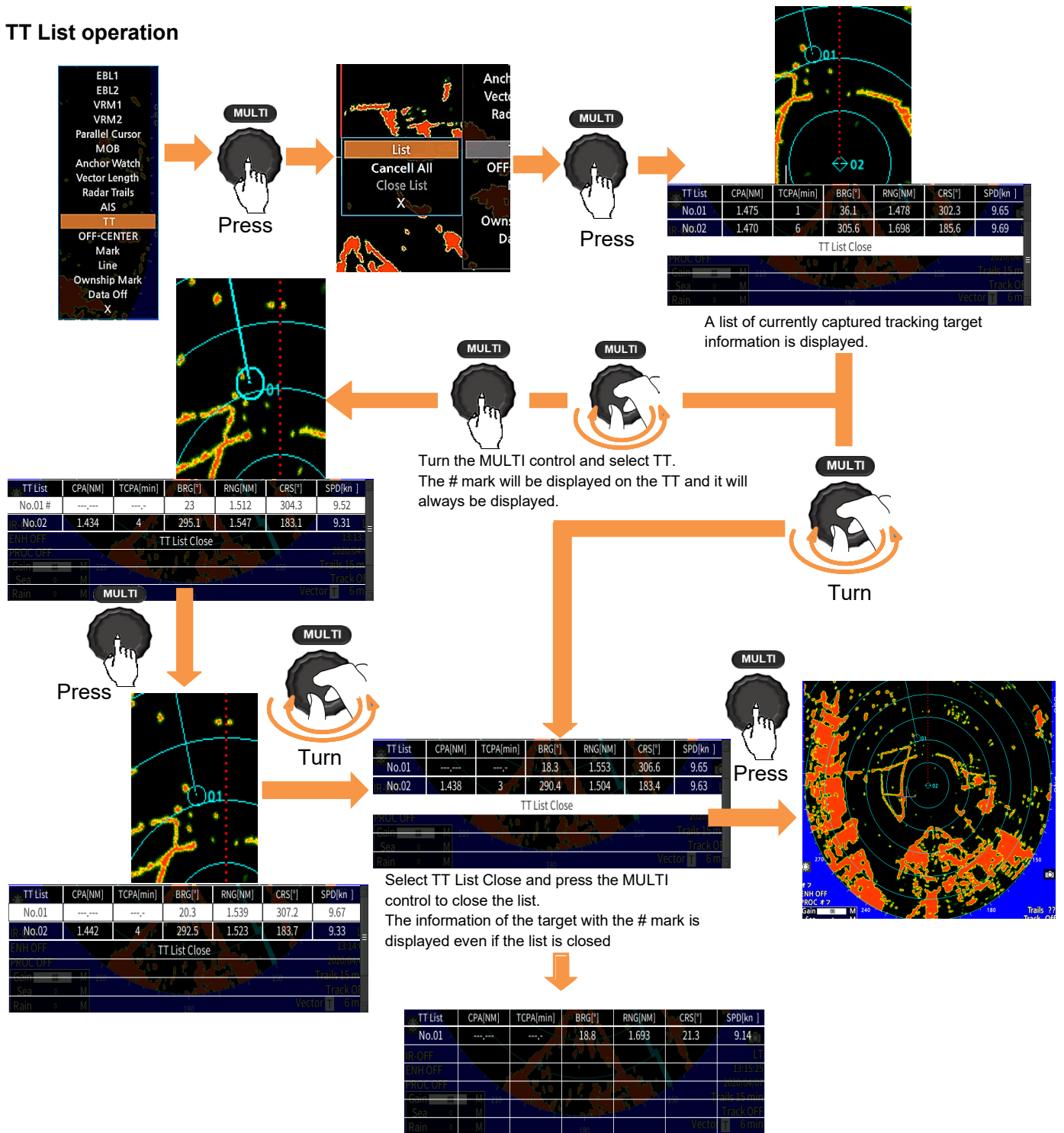

Reference:

■ TT List is displayed as follows.

TT List	CPA[NM]	TCPA[min]	BRG[°]	RNG[NM]	CRS[°]	SPD[kn]
No.01	1.12	1	275.3	1.26	180	4.05

■ The TT List can display information for the maximum number of tracking of the TT function.

### Cancel the all acquisition TT

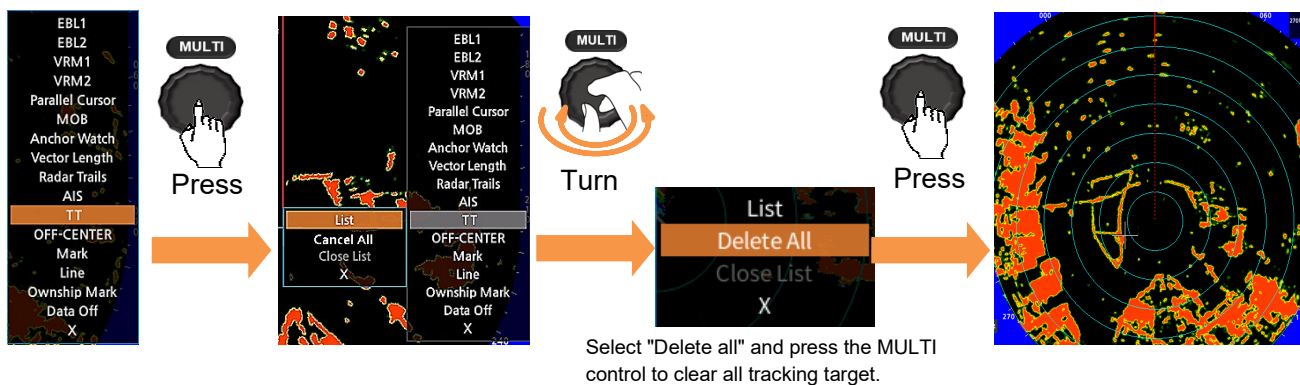

#### Reference:

##### Manual acquisition

The target can be acquired manually by following procedures.

1. Move the cross cursor to location where want to acquire with the MULTI control or the cross key.
2. Press the ENT button.
3. Wait about one minute.





##### Cancel the acquired target

The target can be canceled manually by following procedures.

1. Move the cross cursor to target where want to cancel with the MULTI control or the cross key.
2. Press the CLR button.

Reference:

Symbols of AIS displayed on the screen

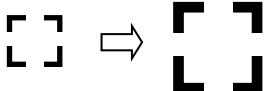
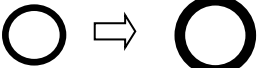
Symbol	Definition	Remarks
	Initial acquisition	This symbol is displayed where the target is acquired. The middle of the line is displayed as an empty square. The same initial acquisition symbol is displayed for both manual acquisition and automatic acquisition.
	Tracking target	This symbol is displayed for the target which becomes the tracking target after acquired. This is displayed with a circle of solid line.
	Lost	When a tracking target is no longer detected as a target, this symbol is superimpose-displayed on the target symbol. This is displayed with cross lines.
  Normal target      Dangerous target	Dangerous target	A red symbol is displayed when the initial acquisition and tracking targets become dangerous targets by CPA / TCPA judgment.
  Unselected target      selected target	Selection/ Numerical display	This radar can always display the numerical information of one tracking target on the screen. The symbol of the target set to always display numerical values is highlighted with a thick line about twice as large as the target symbol that is not set to display numerical values at all times.



## 5.8 OFF-CENTER FUNCTION

The own ship's display position can be moved to any point within 66% of the screen radius.

\*The screen radius means the observation range.

The position setting is registered in advance in the MULTI control menu.

Therefore, the position can be changed quickly according to the purpose.

The registered position settings are as follows.

- Right 44%
- Left 44%
- Backward 44%
- Backward 66%
- Previous

### Reference:

In the Main Menu, the off-center position can be set to other positions.

Refer to "5.22 OFF-CENTER SETTING" for detailed setting method.

If select the "Previous" from the MULTI control menu, the position even where set in "5.22 OFF-CENTER SETTING" can be set.

### Procedures

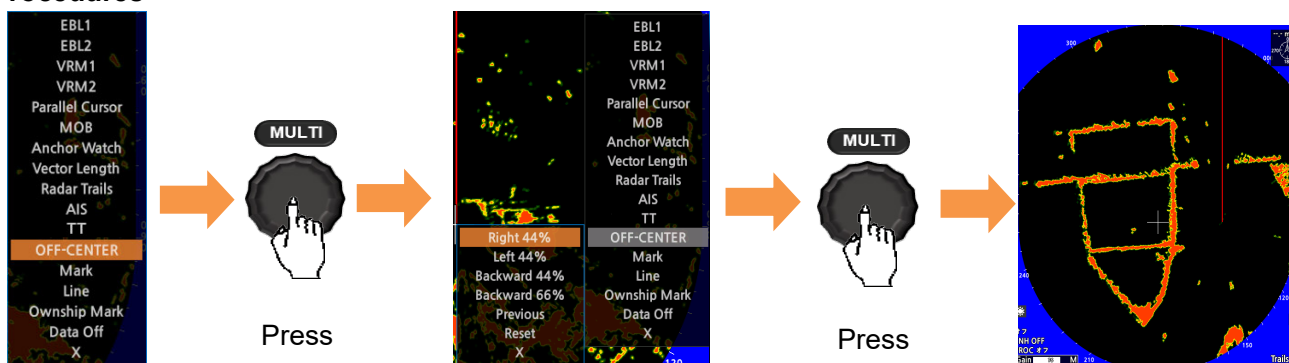

## 5.9 MARK FUNCTION

Marks can be indicated at any positions on the screen.

A mark created on the screen holds the latitude and longitude.

### Make Mark

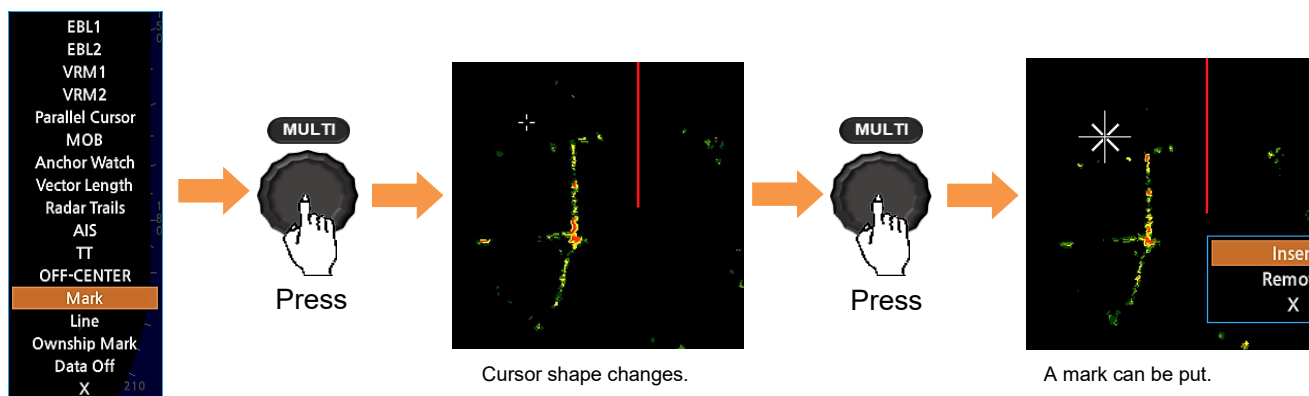



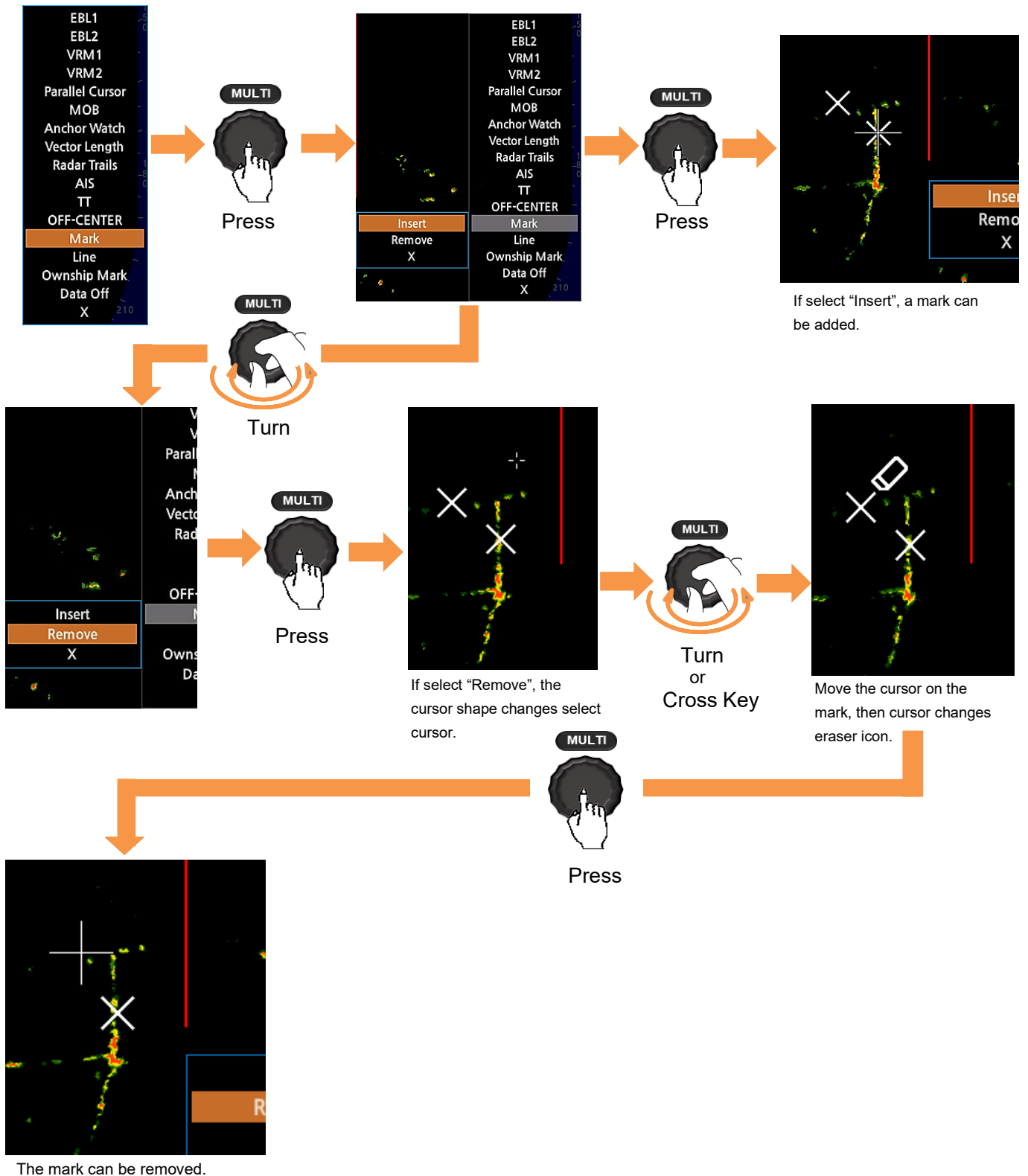

Add/Remove the Mark



The Mark function memorizes the position using latitude and longitude. GPS position information signal must be input. Therefore, this function cannot be used unless GPS is input.

If change the size, color, or type of the mark, see "5.29 MARK SETTING."

**Reference:****List of mark types that can be set**

	× type
	+ type
	Y type
	Drum type

**Delete All Marks**

To delete the set marks at once, focus on the Mark on the MULTI menu and long press the MULTI control.

Displays the delete confirmation screen.

Select YES, the all marks will be deleted at once.

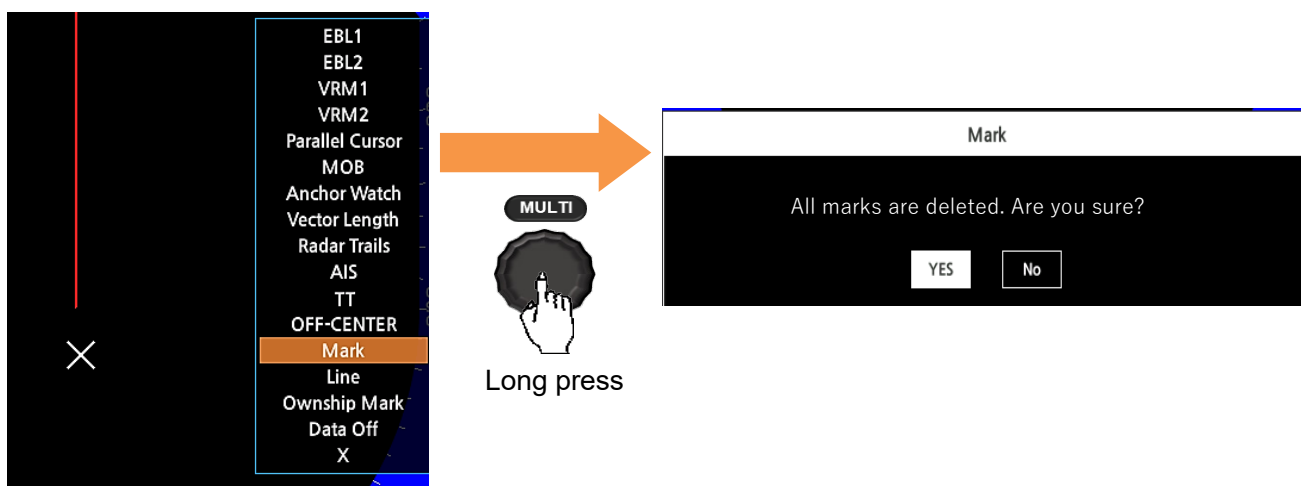

# 5.10 LINE FUNCTION

Lines can be indicated at any positions on the screen.

A line created on the screen holds the latitude and longitude.

## Make Line

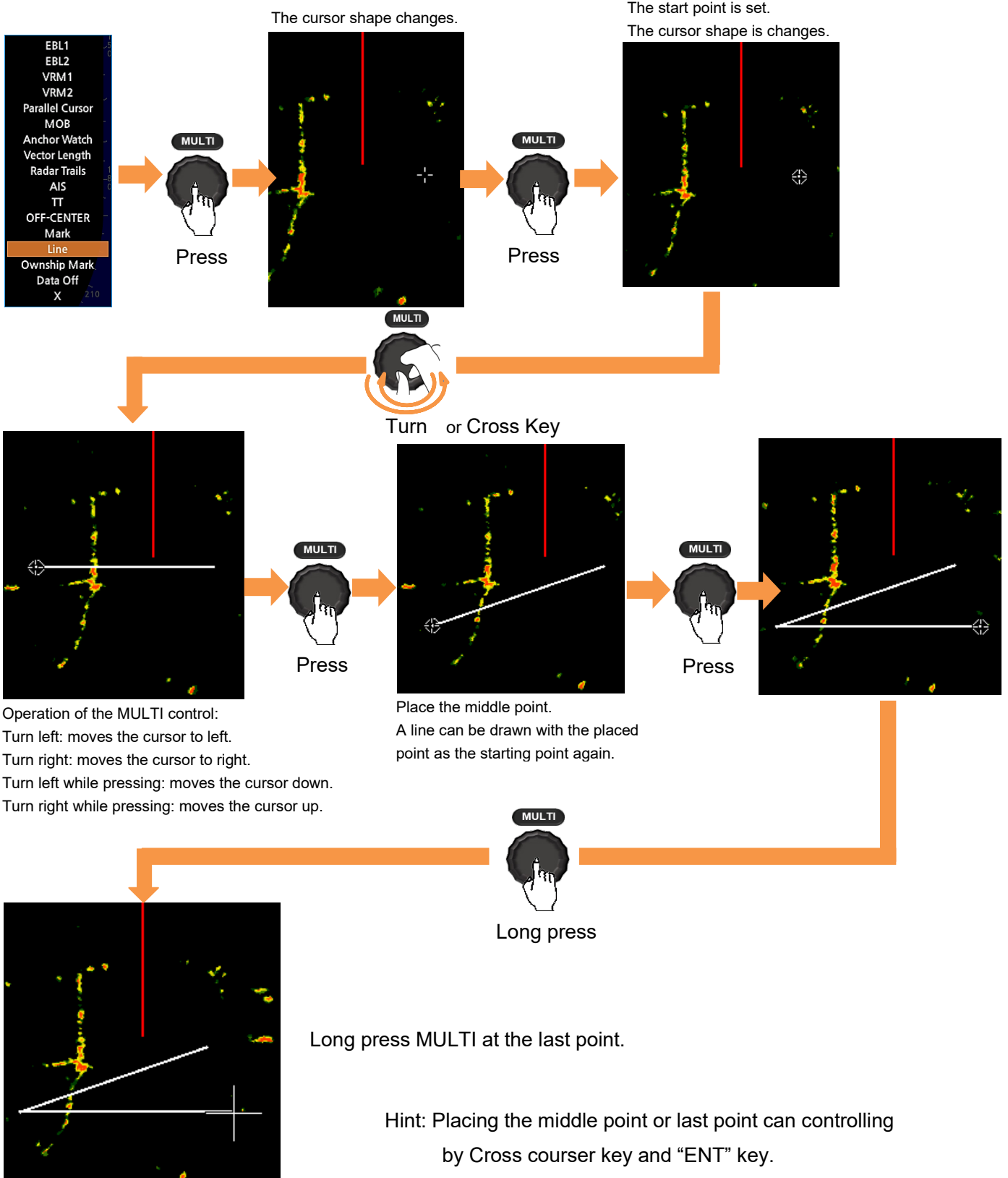

Add/Remove the Line

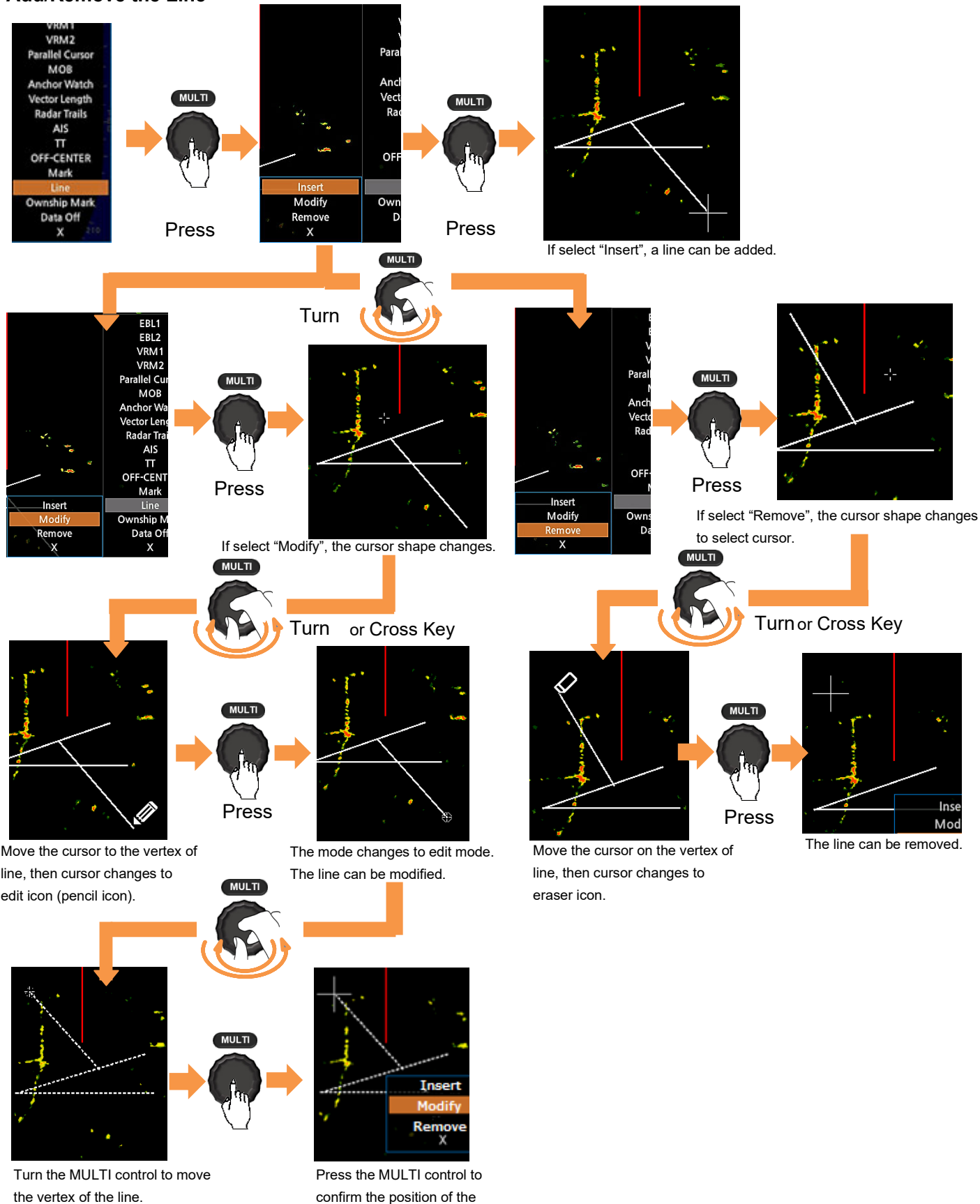

The Line function memorizes the position using latitude and longitude. GPS position information signal must be input. Therefore, this function cannot be used unless GPS is input.

If change the color or type of the line, see "5.31 LINE SETTING."

Reference:

**Delete All Lines**

To delete the set lines at once, focus on the Line on the MULTI menu and long press the MULTI control. Displays the delete confirmation screen.

Select YES, the all lines will be deleted at once.

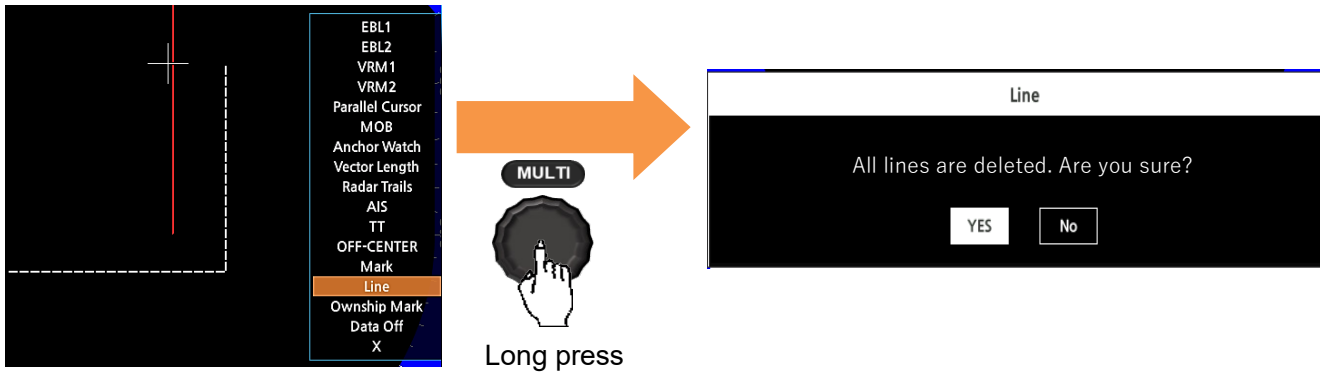

# 5.11 OWNSHIP MARK FUNCTION

Marks can be indicated at own ship's position on the screen.  
 A mark created on the screen holds the latitude and longitude.

## Make Ownship Mark

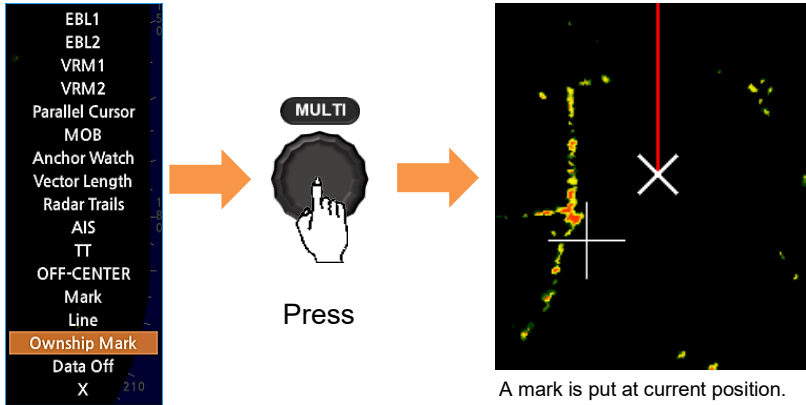

## Add/Remove the Ownship Mark

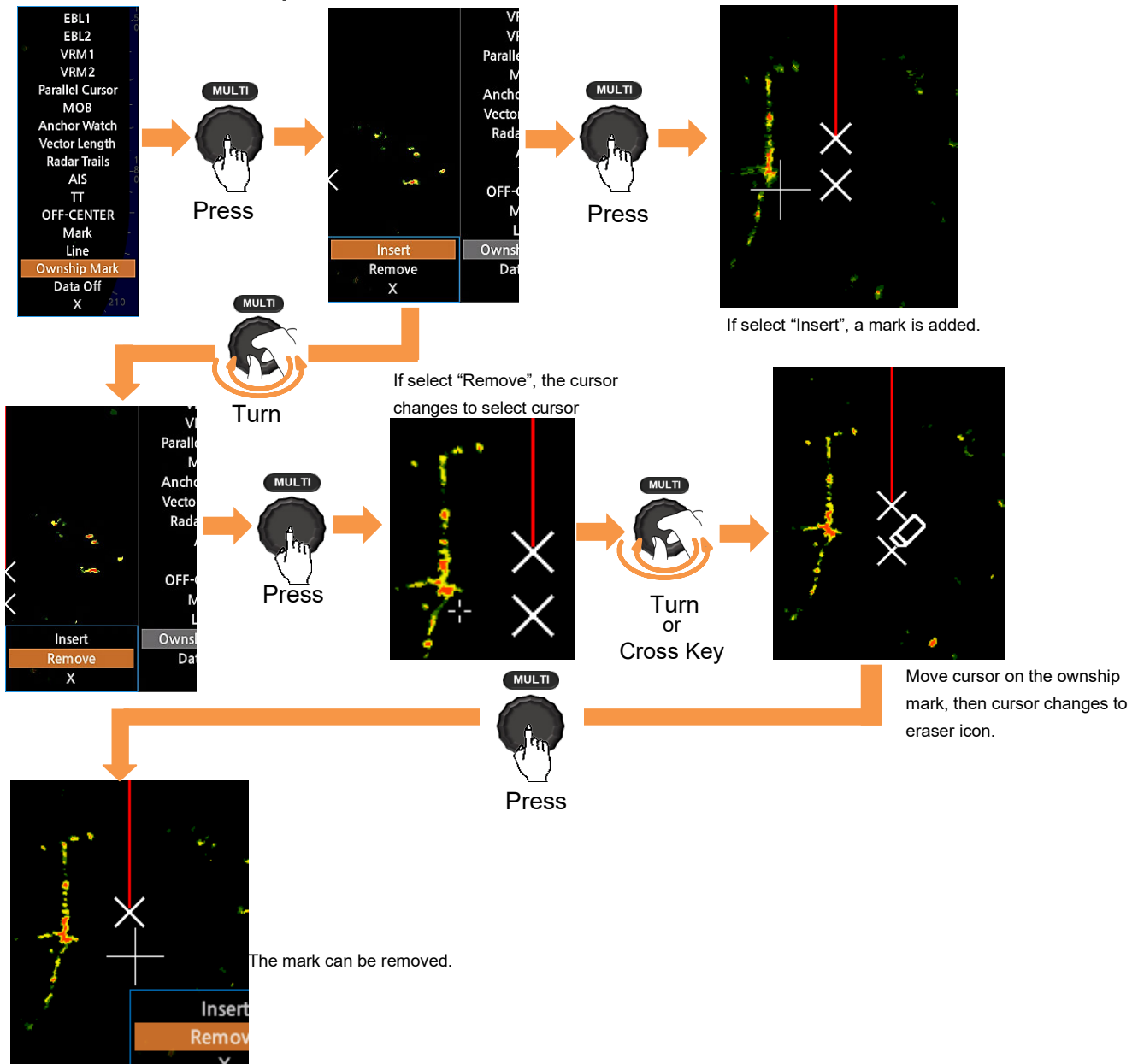





The Ownship Mark function memorizes the position using latitude and longitude. GPS position information signal must be input. Therefore, this function cannot be used unless GPS is input.

If change the size, color or type of the mark, see “5.30 OWNSHIP MARK SETTING.”

**Reference:**

**List of mark types that can be set**

	× type
	+ type
	Y type
	Drum type

**Delete All Ownship Marks**

To delete the set marks at once, focus on the Ownship Mark on the MULTI menu and long press the MULTI control.

Display the delete confirmation screen.

Select YES, the all marks will be deleted at once.

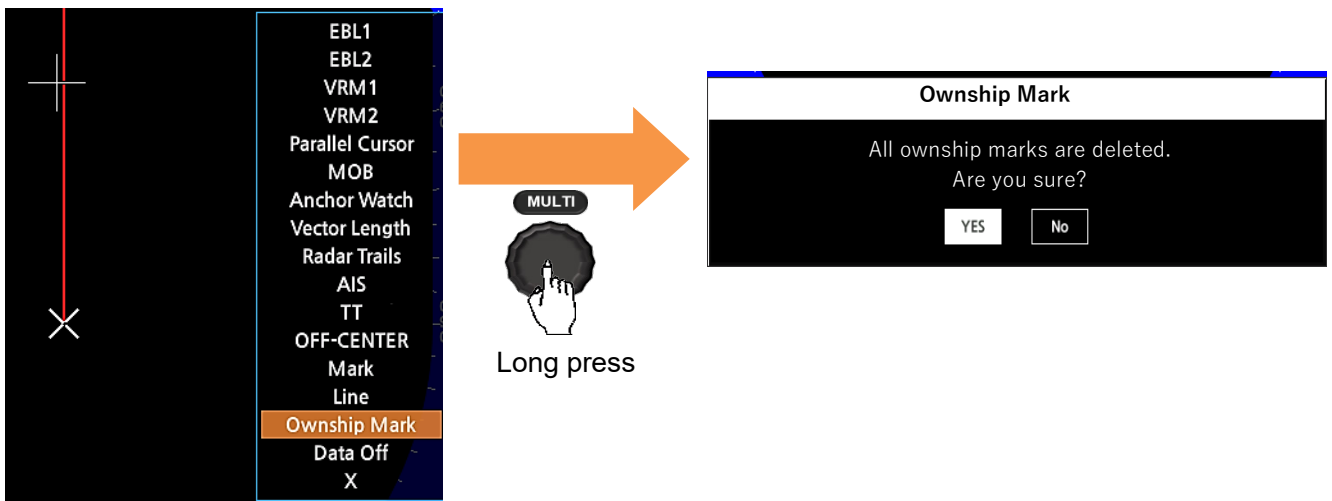



## 5.12 USER OPTION KEYS

USER1 and USER2 buttons can be assigned menu shortcuts for each short press/long press. The frequently used menus can be called up immediately.

**Registration procedure** (The images are examples)

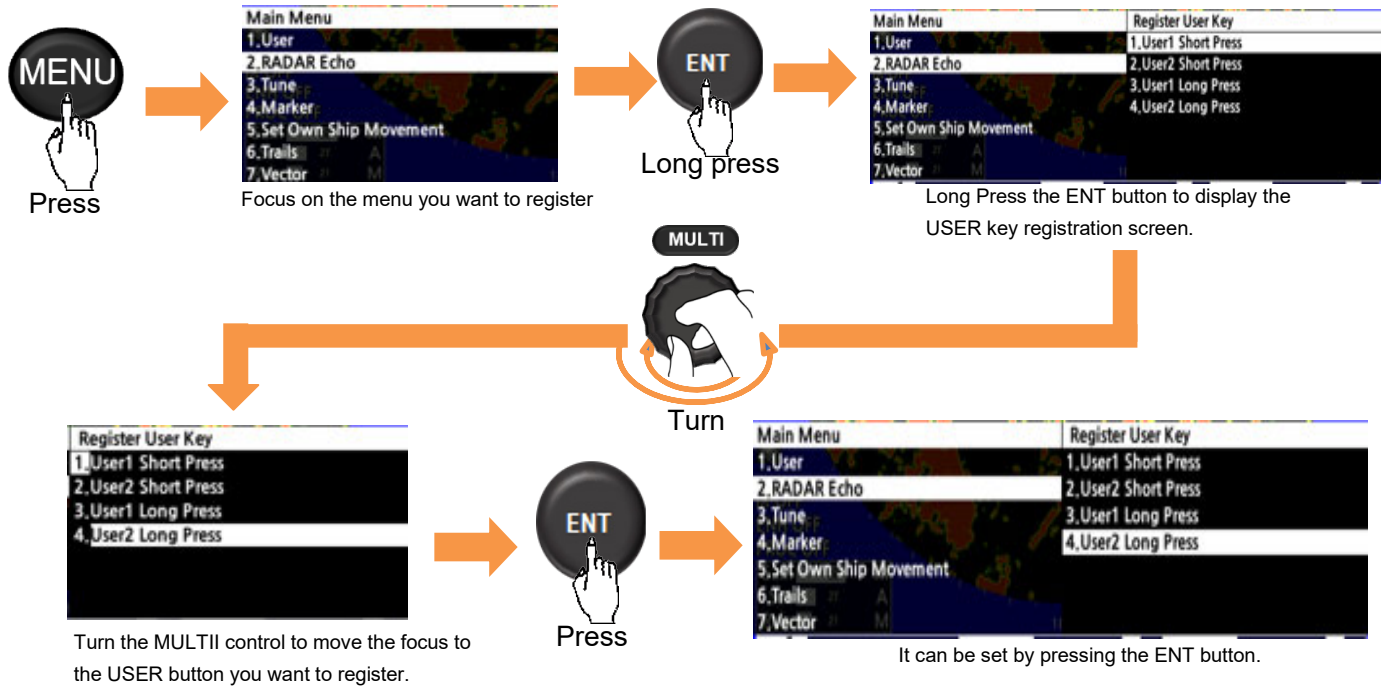

**Confirmation and cancellation of registered contents**

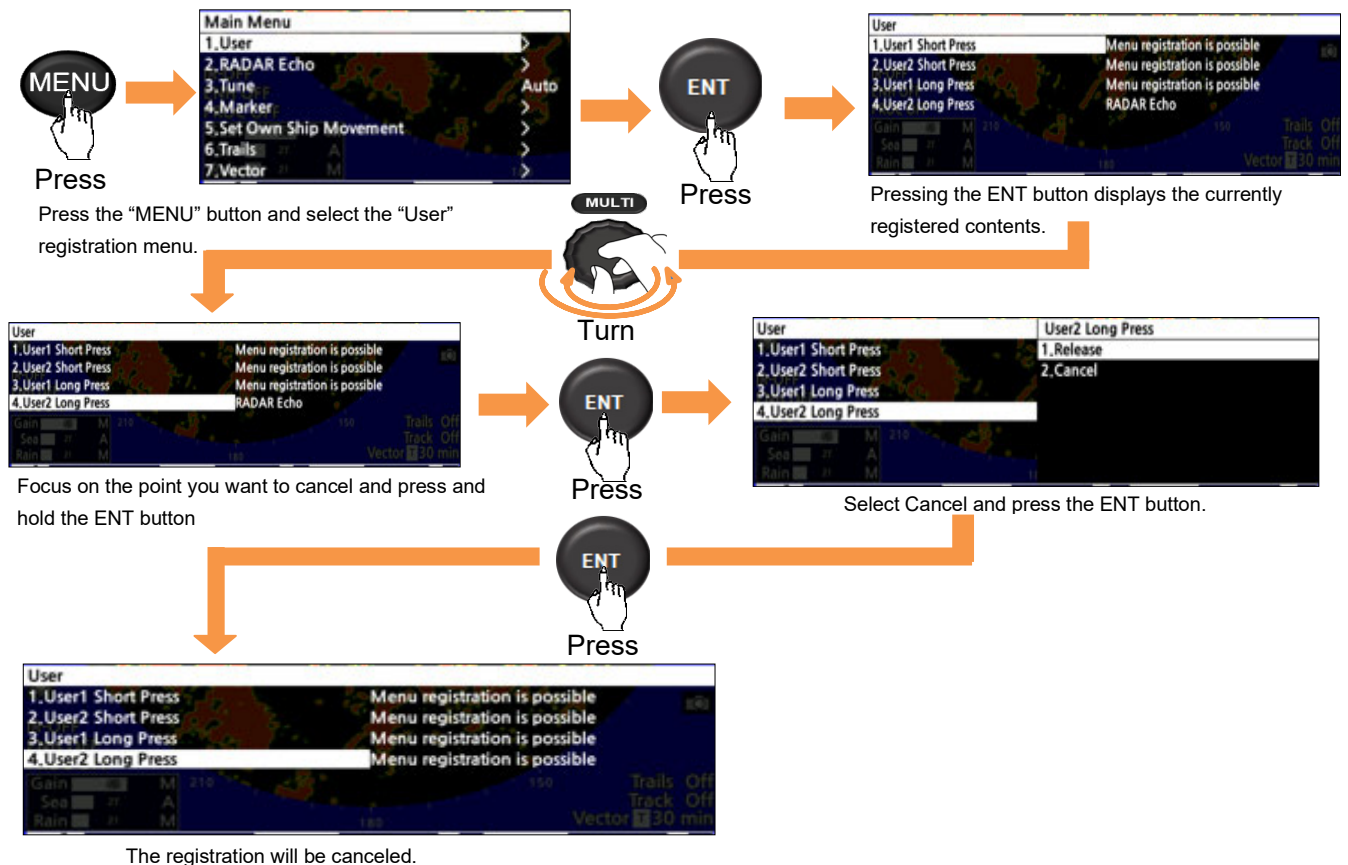

**Reference:**

When the Capture function or TLL Tx function are assigned to the USER1 or USER2 button, those functions and the function registered with the user registration menu operates simultaneously.

## 5.13 MODE FUNCTION

By pressing the FUNC button, it is possible to switch to a mode according to the observation scene.

It is also possible to change to the desired video settings using each mode.

For details, refer to "5.23 FUNCTION SETTING."

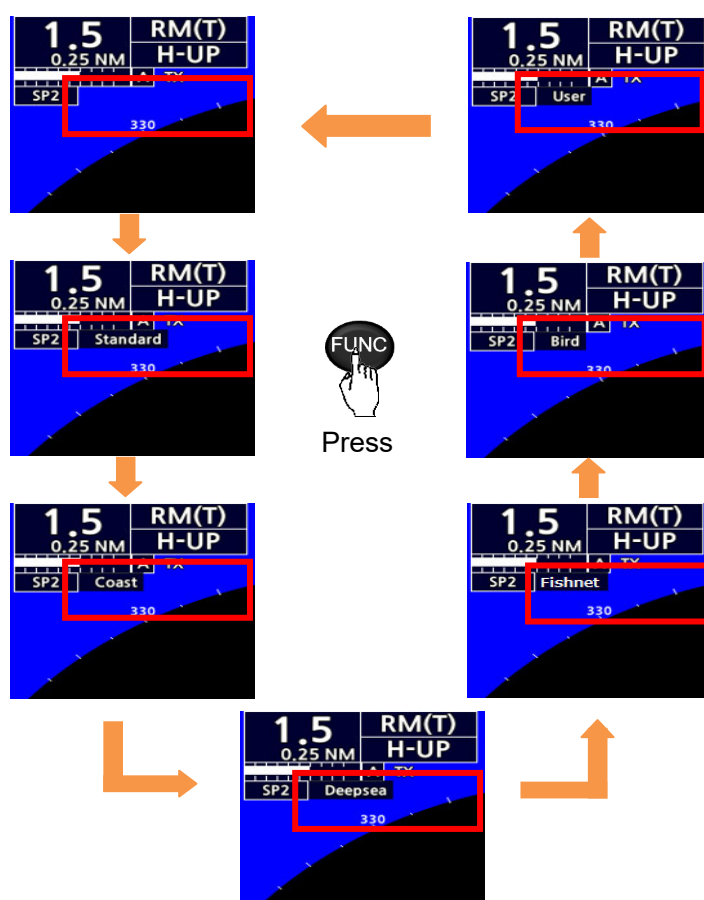
**Note:**

When the function setting is "None", the values set in various processing setting items other than the "Function Setting" menu are applied.

**Note:**

If "Default" is described in the following antenna heights, the antenna height setting value set in the "Adjust Menu" is applied.

**Initial value of each function mode**

Mode Setting item	Standard	Coast	Deepsea	Fishnet	Bird	User *For stormy weather
IR	Middle	Middle	Middle	Middle	Low	Middle
Process	OFF	3Scan CORREL	3Scan CORREL	5Scan CORREL	Peak Hold	5Scan CORREL
Target Enhance	Level 2	Level 2	Level 2	Level 2	Level 2	Level 1
AUTO STC/FTC	OFF	OFF	AUTO STC	OFF	AUTO STC	AUTO STC + AUTO FTC
Video Latitude	Normal	Narrow	Wide1	Wide 2	Max	Wide2
Video Noise Rejection	Level 2	Level 3	Level 1	Level 1	Level 1	Level 1
Trails Interval	OFF	3 min	3 min	3 min	3 min	3 min
Trails Mode	True	True	True	True	True	True
Threshold	Level 4	Level 4	Level 4	Level 4	Level 4	Level 4
Time/All Combine	OFF	OFF	OFF	OFF	OFF	OFF
MAX Interval	Short	Short	Short	Short	Short	Short
PRF	Normal	High Power	Normal	Normal	High Power	Normal
Antenna Height	Default	5 - 10m	10 - 20m	Default	20m -	20m -

## 5.14 SETTING DISPLAY BRILLIANCE AND COLOR

The BRILL control has three functions that can be used to easily change the color and brightness of the screen.

① Turn the BRILL control

By turning the BRILL control, change the brightness of the screen.

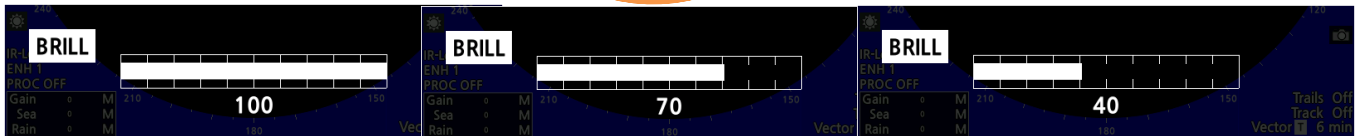
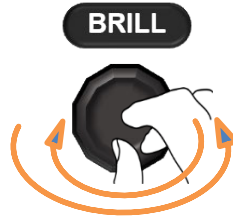

② Press the BRILL control

By pressing the BRILL control, switch the color in order to Day -> Dusk -> Night.

To change the color displayed in each mode, see “8.9.2 DISPLAY COLOR.”

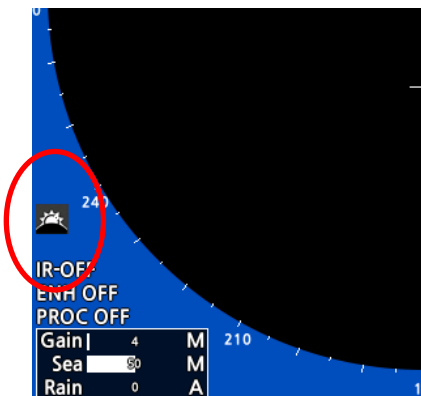
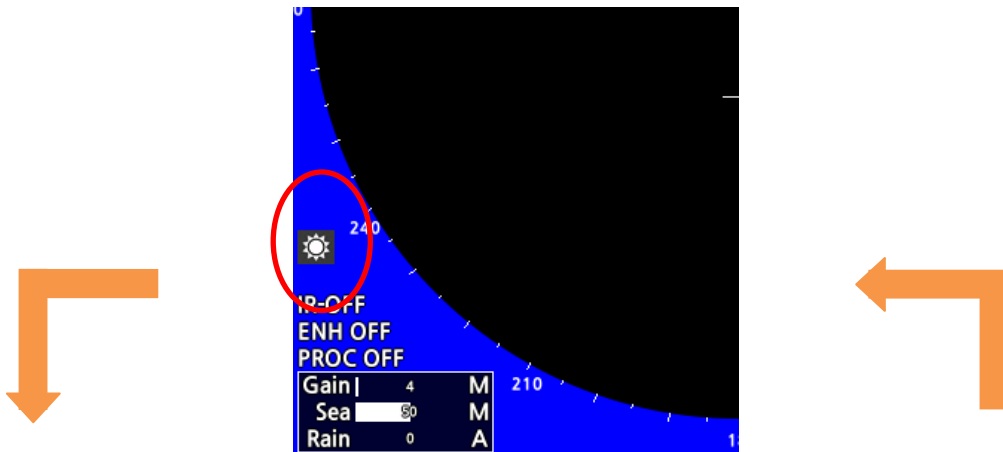

BRILL



Press

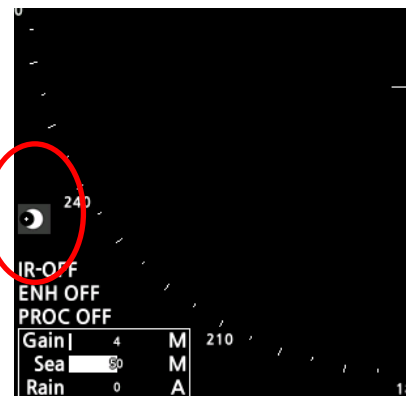

③ Long press the BRILL control

By long pressing the BRILL control, screen brightness turns to level 100 (maximum).

## 5.15 CURSOR FUNCTION

Information on the cross cursor can be displayed on the screen.

- Distance and direction from own ship to cursor position
- Latitude and longitude of the cursor position
- Arrival time to current cursor position

The cursor function is OFF in the initial state.

Refer to “8.9.3 OPERATION NUMERIC DISPLAY” for the setting method.

**Note:**

It is recommended to set this function after the Numeric Display (4).

The Numeric Display (0) to (3) have been used for another function in the initial state. If change those settings, the speed display and coordinate position display may not be displayed.

## 5.16 RADAR ECHO SETTING

It is used when you want to adjust the settings of your favorite radar image.

① Press the MENU button.

② Select "RADAR Echo."



### Pulse Width

- |             |
|-------------|
| Pulse Width |
| 1. MP2      |
| 2. LP1      |
| 3. LP2      |

### IR

- |           |
|-----------|
| IR        |
| 1. OFF    |
| 2. Low    |
| 3. Middle |
| 4. High   |

### Target Enhance

- |                |
|----------------|
| Target Enhance |
| 1. OFF         |
| 2. Level1      |
| 3. Level2      |
| 4. Level3      |

### Process

- |                 |
|-----------------|
| Process         |
| 1. OFF          |
| 2. 3Scan CORREL |
| 3. 4Scan CORREL |
| 4. 5Scan CORREL |
| 5. Remain       |
| 6. Peak Hold    |

③ Select each menu.

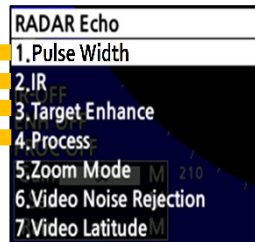

### Zoom Mode

- |                |
|----------------|
| Zoom Mode      |
| 1. OFF         |
| 2. Zoom x2     |
| 3. Zoom Circle |

### Video Noise Rejection

- |                       |
|-----------------------|
| Video Noise Rejection |
| 1. OFF                |
| 2. Level1             |
| 3. Level2             |
| 4. Level3             |

### Video Latitude

- |                |
|----------------|
| Video Latitude |
| 1. Narrow      |
| 2. Normal      |
| 3. Wide1       |
| 4. Wide2       |
| 5. Max         |

## 5.16.1 PULSE WIDTH

You can change the transmission pulse width. Options of the transmitter pulse width vary depending on the range. For details, see following list.

Range	Pulse Width (JMA-3404)	Pulse Width (JMA-3406)	Pulse Width (JMA-3411)
0.125NM	SP1	SP1	SP
0.25NM	SP1	SP1	SP
0.5NM	SP1/MP1	SP1/MP1	SP/MP1
0.75NM	SP2/MP1	SP2/MP1	SP/MP1
1.5NM	SP2/MP1/MP2	SP2/MP1/MP2	SP/MP1/MP2
3NM	SP3/MP1/MP2	SP3/MP1/MP2	MP1/MP2/LP1
6NM	MP2/LP1/LP2	MP2/LP1/LP2	MP2/LP1/LP2
12NM	MP2/LP1/LP2	MP2/LP1/LP2	MP2/LP1/LP2
24NM	LP2	LP2	LP2
48NM	LP2	LP2	LP2
72NM	—	LP2	LP2

SP(Short Pulse): The transmission pulse width becomes shorter, and the range resolution improved.

The suppression of sea clutter or rain/snow clutter is heightened.

Recommended conditions are following.

- In bays/harbors and narrow waterway where targets are densely crowded.
- Rough sea state due to torrential rain or stormy weather.

MP(Middle Pulse): The normal transmission pulse width is set. Both range resolution and sensitivity are appropriately set. Recommended conditions are General navigation.

LP(Long Pulse): The transmission pulse width becomes longer, and sensitivity improved.

Small targets are zoomed and are easy to observe. When the sea state is bad, detection performance decreases. Recommended conditions are following.

- Detection of small targets in good weather conditions, at long range.

## 5.16.2 IR (INTERFERENCE REJECTION)

You can eliminate the interference from other radars by setting an appropriate IR level. However, if a higher IR level is selected, the detection of small targets such as buoys and small boats become difficult. In general, "Low" level should be selected.

### 5.16.3 TARGET ENHANCE

The dimension of video display is enlarged by the target enhancement function. And radar echo display of two targets is closing in angle and distance. As a result, may be displayed in PPI screen as one target.

OFF: Select this mode particularly when resolution is required.

Level1: Select this mode in general.

Expand the radar echo area at 1 step for vertical direction and at 1 step for horizontal direction.

Level2: Select this mode to easily view the radar video.

Expand the radar echo area at 1 step for vertical direction and at 2 steps for horizontal direction.

Level3: Select this mode to detect small targets such as buoys.

Expand the radar echo area at 2 steps for vertical direction and at 3 steps for horizontal direction.

When Level3 is selected, sea clutter and rain/snow clutter are apt to be enhanced.

When using this enhance mode, suppress sea clutter and rain/snow clutter. For details of settings, refer to "3.3 SEA CLUTTER SUPPRESSION (SEA)" and "3.4 RAIN/SNOW CLUTTER SUPPRESSION (RAIN)."

In general, Level1 or Level2 should be selected.

### 5.16.4 PROCESS

This function reduces unnecessary noise to highlight targets. When viewing a radar beacon, SART signal, or fast-moving target on the radar display, do not use this function. This function is suitable for using in TM mode. The bearing data input is required for video processing.

OFF: Select this mode in general.

3Scan-CORREL: Select this mode when many Rain/Snow clutter are detected.

4Scan-CORREL: Select this mode to highlight targets while suppressing sea clutter.

5Scan-CORREL: Select this mode to detect small targets hidden by sea clutter.

Remain: Select this mode when own ship yaws wildly.

Peak Hold: Select this mode to detect small targets of which detection probability is low.

When "CORREL" is set, the image becomes smaller. When "Remain" or "Peak Hold" is set, the afterimage will appear.

### 5.16.5 ZOOM MODE

This function is zooming in the radar video display.

There are two type of zoom mode, "Zoom x2" and "Zoom Circle."

"Zoom x2" doubles the size of radar video. The display is zoomed around the own ship's position as the center when this function is executed.

While this function is performed, range is displayed by half.

This function is turned off when range is changed.

"Zoom Circle" is turned on, the zoom circle displayed on the PPI.

The zoom circle can be moved by operating cross key or the MULTI control.

Both of the functions are cannot be used in minimum range.



### 5.16.6 VIDEO NOISE REJECTION

This function rejects signals that assumed as noise and clutter in radar videos.

OFF: Turn off the noise rejection function, and display all signals. Targets are popped up from noise and displayed like analog signals.

Level1: Reject the signals of definitely unwanted waves (noise and clutter). When detection of targets or unwanted waves in no definite, signals are displayed. When detection of targets is definite, signals are displayed.

Level2: Reject signals of definitely unwanted waves (noise and clutter). When detection of targets or unwanted waves in no definite, the signals are displayed. When detection of targets is definite, the signals are displayed. It will remove the signal that can be regarded as unnecessary wave of more than level 1.

Level3: Select if "Level1" and "Level2" cannot reject signals enough.

### 5.16.7 VIDEO LATITUDE

Select the dynamic range in which receiving signals are to be shown on the radar display.

Narrow: Narrow the dynamic range at short range.

Normal: Standard setting. The dynamic range varies depending on the actual range.

Wide1: Use this mode when rainy weather intensifies unwanted waves. The dynamic range is about twice as wide as when Normal is selected.

Wide2: Use this mode when rain clouds remain even when using Wide1.

Max: Use this mode when you want to fine-tune the image for weak reflectors such as rain clouds. Dynamic range is 2.5 ~ 5 times as large as normal.

Select Normal in standard, and Wide1 in rainy weather. Narrow clearly displays short-range videos when STC is used in manual mode.

## 5.17 TUNE

Automatic tuning mode (AUTO) and manual tuning mode (MANUAL) are provide. In the automatic tuning mode, transmission and receiving frequencies are tuned and adjusted automatically. In the manual tuning mode, tuning is carried out by yourself.

When “AUTO” is selected, the equipment automatically adjust tuning. Tuning is adjusted when the range is changed or pulse width is changed.

When “MANUAL” is selected, adjust the video to be the largest by observing the tune indicator bar. Because the tune indicator bar is the guide during manual tuning, adjust the tune indicator bar to the maximum.

① Press the MENU button.

② Select “Tune.”

③ Select “Manual” or “Auto.”

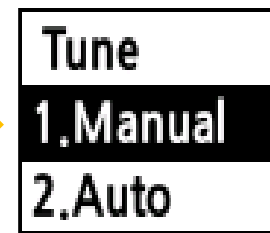
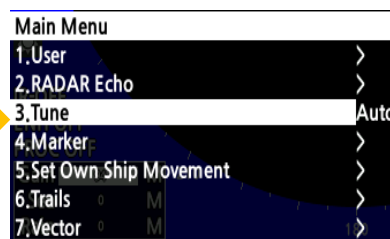
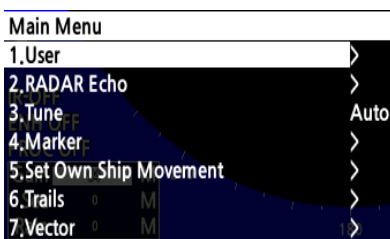

Manual Selected

Auto Selected

④ Use the cross key or the MULTI control to adjust the tuning bar.

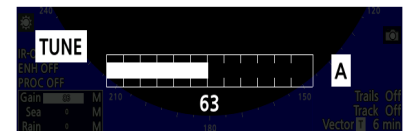
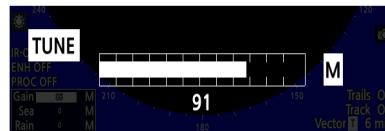
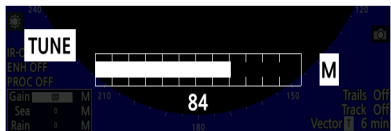

Tune is automatic.  
 Only confirmation to be Auto.

## 5.18 MARKER

Set operations for EBLs, parallel cursors, cursor mode and range rings.

Also set unit of VRMs.

① Press the MENU button.



② Select "Marker."

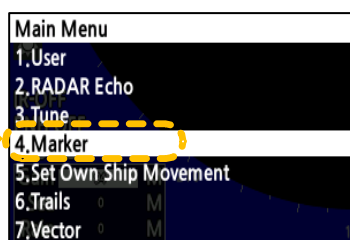

③ Select each menu.

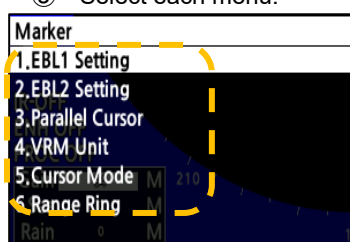

EBL Setting	Parallel cursor	VRM Unit	Cursor Mode	Range Ring																								
<table border="1"> <tr><td><b>EBL1 Setting</b></td></tr> <tr><td>1. Floating</td></tr> <tr><td>2. Bearing Mode</td></tr> </table>	<b>EBL1 Setting</b>	1. Floating	2. Bearing Mode	<table border="1"> <tr><td><b>Parallel Cursor</b></td></tr> <tr><td>1. Range Scale Link</td></tr> <tr><td>2. Floating</td></tr> <tr><td>3. Bearing Mode</td></tr> <tr><td>4. One/Both Sides</td></tr> <tr><td>5. Display For Individual Line1</td></tr> <tr><td>6. Display For Individual Line2</td></tr> <tr><td>7. Display For Individual Line3</td></tr> </table>	<b>Parallel Cursor</b>	1. Range Scale Link	2. Floating	3. Bearing Mode	4. One/Both Sides	5. Display For Individual Line1	6. Display For Individual Line2	7. Display For Individual Line3	<table border="1"> <tr><td><b>VRM Unit</b></td></tr> <tr><td>1. NM</td></tr> <tr><td>2. km</td></tr> <tr><td>3. sm</td></tr> <tr><td>4. Link Range</td></tr> </table>	<b>VRM Unit</b>	1. NM	2. km	3. sm	4. Link Range	<table border="1"> <tr><td><b>Cursor Mode</b></td></tr> <tr><td>1. Bearing Mode</td></tr> <tr><td>2. Unit</td></tr> <tr><td>3. Size</td></tr> <tr><td>4. Pattern</td></tr> </table>	<b>Cursor Mode</b>	1. Bearing Mode	2. Unit	3. Size	4. Pattern	<table border="1"> <tr><td><b>Range Ring</b></td></tr> <tr><td>1. Off</td></tr> <tr><td>2. On</td></tr> </table>	<b>Range Ring</b>	1. Off	2. On
<b>EBL1 Setting</b>																												
1. Floating																												
2. Bearing Mode																												
<b>Parallel Cursor</b>																												
1. Range Scale Link																												
2. Floating																												
3. Bearing Mode																												
4. One/Both Sides																												
5. Display For Individual Line1																												
6. Display For Individual Line2																												
7. Display For Individual Line3																												
<b>VRM Unit</b>																												
1. NM																												
2. km																												
3. sm																												
4. Link Range																												
<b>Cursor Mode</b>																												
1. Bearing Mode																												
2. Unit																												
3. Size																												
4. Pattern																												
<b>Range Ring</b>																												
1. Off																												
2. On																												

### 5.18.1 EBL SETTING

Set operation for EBLs.

Set the mode to move starting point of EBL ("Floating").

Floating

Off: Floating mode is disabled.

Screen FIX: Starting point of EBL is fixed on the radar display.

Lat/Lon Fix: Starting point of EBL is fixed at specific latitude and longitude.

Set the EBL bearing fix mode ("Bearing Mode").

Bearing Mode

True: Numerical value of the EBL direction is fixed to the true direction based on the north (0°).

Relative: Fixe EBL bearing value to a relative bearing based on the heading of own ship (0°).

These settings can be set to each EBL.

## 5.18.2 PARALLEL CURSOR

Set the operation for parallel cursors.

When a range is switched, parallel cursors link to a radar range scale for display ("Range Scale Link").

Range Scale Link Off: If the range is switched, the width between parallel index lines changes in accordance with the radar range scale.

On: If the range is switched, the width between parallel index lines remains fixed.

Set the mode to move starting point of parallel cursors ("Floating").

Floating Off: Floating mode is disabled.

Screen Fix: Fixe start point of parallel cursor to the radar display.

Lat/Lon Fix: Starting point of parallel cursor is fixed at specific latitude and longitude.

Set bearing fix mode of parallel cursors ("Bearing Mode").

Bearing Mode Angle Fix: The angle of parallel cursors is set in true bearing.

For N Up and C Up, the cursors are displayed in true bearing irrespective of changes in the course of own ship.

For H Up, the angle of the parallel cursors changes as the course of own ship changes.

Screen Fix: Fix parallel cursor display to the radar display.

The angle of parallel cursors stays the same on the screen regardless of own ship movement.

When own ship is engaged in TM motions, parallel cursors move as own ship moves.

Heading Fix: parallel cursors are displayed while the relative angle of the ship's heading bearing line stays the same.

For H Up, the ship's heading bearing line does not change even though the course of own ship changes; therefore, the parallel cursors do not move.

For N Up, the ship's heading bearing line changes as the course of own ship changes; therefore, the parallel cursors also change as the course of own ship changes.

Select "One Side" or "Both Sides" for parallel cursor display ("One/Both Sides").

One Side: Parallel cursors are displayed in "One Side" mode.

Both Sides: Parallel cursors are displayed in "Both Sides" mode.

Individual parallel cursors can be displayed/hidden ("Display For Individual Line").

Display For Individual Line Off: Parallel cursor is not displayed.

On: Parallel cursor is displayed.

The line nearest to the own ship is specified as Line1.

### 5.18.3 VRM UNIT

Set the VRM unit.

The unit can be selected from following.

NM/km/sm/Link Range

When "Link Range" is selected, it is linked to the unit of the observation range. (Refer to "Range" in "8.8.6 UNIT")

### 5.18.4 CURSOR MODE

This function enables the setting of detail information about cursor display.

Set the bearing mode, length, unit and pattern of cursor.

Set the bearing mode of cursor ("Bearing Mode"). Bearing mode is selected "True" or "Relative."

When "True" is selected, true bearing of cursor is displayed.

When "Relative" is selected, the relative angle of the own ship's heading bearing is displayed as the bearing of cursor.





Set the distance unit for cursor ("Unit").

Unit is selected from "NM", "km", "sm" and "Link Range."

Set the length of the cross-cursor mark on the radar display ("Size").

Select the type of the cursor mark on the radar display ("Pattern").

Pattern is selected from following list.

Thin Cross	
Thin Cross (Empty of Center)	
Thick Cross	
Thick Cross (Empty of Center)	

Numeric display uses these settings of bearing mode and unit in this function.

For details of numeric display setting, see "8.9.3 NUMERIC DISPLAY."

## 5.18.5 RANGE RING

Set the display of range ring on the radar screen.

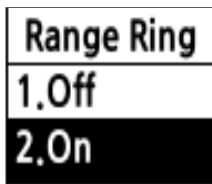

If turn on, the range rings are displayed.

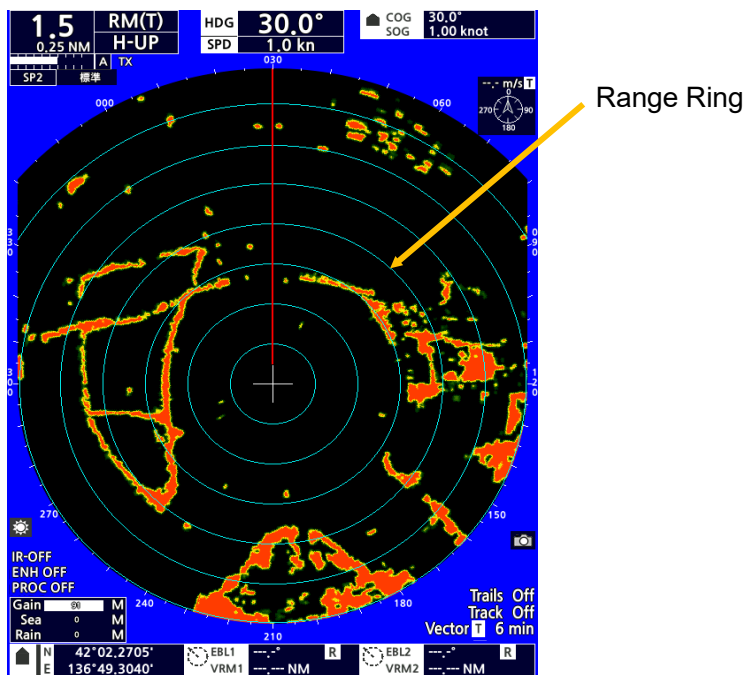

## 5.19 SET OWN SHIP MOVEMENT

① Press the MENU button.



② Select "Set Own Ship Movement."

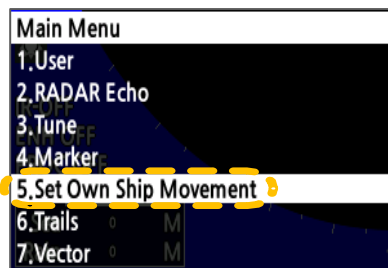

③ Select each menu.

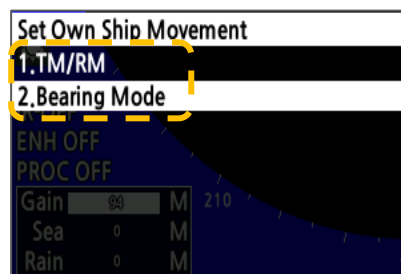

TM/RM		Bearing Mode	
Set Own Ship Movement	TM/RM	Set Own Ship Movement	Bearing Mode
1. TM/RM	1. RM	1. TM/RM	1. Head Up
2. Bearing Mode	2. TM	2. Bearing Mode	2. North Up
ENH OFF		3. Course Up	
PROC OFF		4. Course Up Reset	
Gain 99 M 210		Gain 99 M 210	
Sea 0 M		Sea 0 M	
Rain 0 M		Rain 0 M	

**TM/RM:** Switches between true and relative motion display modes. The bearing signal input is required to display true motion.

In the true motion display mode, the own ship's position on the radar screen moves depending on its speed and course and the influence of the current. Land and other fixed targets are fixed on the radar screen and only actually moving targets move on the radar screen.

**Bearing mode:** Select the azimuth of the radar video.

The bearing signal input is required to display N-UP/C-UP.

Head Up (H-UP) mode is displayed so that the ship's heading line points to the zenith of the PPI. Since targets are displayed in their direction relative to the ship's heading line, the operator can view the video in the same field of view as in operating the ship at sea. This mode is suitable for watching over other ships.

North Up (N-UP) mode is displayed so that the zenith of the PPI points to the due north. Fixed targets do not flicker and are easily identified on the chart, and the true bearing of a target can easily be read out.

Course Up (C-UP) mode is fixed pointing to the zenith of the PPI points to the due north. In the same way as in the N-UP mode, fixed targets do not flicker, and are stabilized even if the ship is yawing. The bearing of the heading line varies by the same shift of own ship's course. If the course is changed while "Course Up" is selected, the latest course will be displayed top of the radar screen by selecting "Course Up Reset."

## 5.20 TRAILS SETTING

Set radar trails.

① Press the MENU button.



② Select "Trails."

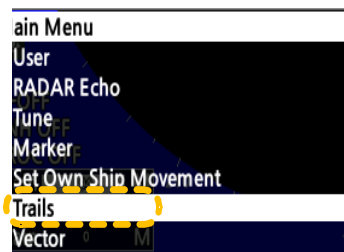

③ Select each menu.

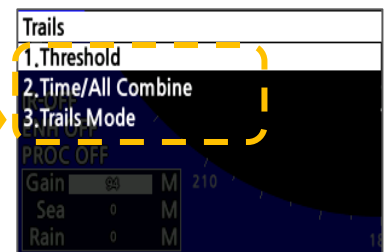

Threshold	
Trails	Threshold
1.Threshold	1.Level1
2.Time/All Combine	2.Level2
3.Trails Mode	3.Level3
	4.Level4

To 5.20.1 ←

Time/All Combine	
Trails	Time/All Combine
1.Threshold	1.Off
2.Time/All Combine	2.On
3.Trails Mode	

To 5.20.2 ←

Trails Mode	
Trails	Trails Mode
1.Threshold	1.True
2.Time/All Combine	2.Relative
3.Trails Mode	

To 5.20.3 ←



### 5.20.1 THRESHOLD

Set the threshold level for making radar trails.

The threshold is higher in the order of level 1 < level 2 < level 3 < level 4.

If the threshold is low, radar trails are plotted even for weak echoes.

If the threshold is high, radar trails are only plotted for strong echoes.

- When radar trails are plotted with unwanted waves, change to a higher level.
- To thin radar trails, change to a higher level.
- If radar trails are plotted in snatches, change to a lower level.

### 5.20.2 TIME/ALL COMBINE

This function superimpose-displays time radar trails and continuous radar trails.

Normally, time radar trails have priority, but if continuous radar trail is selected in the MULTI control menu, only continuous radar trails is displayed.

### 5.20.3 TRAILS MODE

Switch the radar trail display between true and relative motion trail modes.

True motion trails: The system plots the absolute motion trails of a target, irrespective of own ship's position.

The operator can easily judge the course and speed of the target.

The system does not plot the trails of land and other fixed targets.

Relative motion trails: The system plots the trails of a target at a position relative to the own ship.

The operator can easily judge whether the target is approaching the own ship.

While the own ship is moving, the system also plots the trails when the own ship is turning.

## 5.21 VECTOR

Set TT and AIS vector settings. The bearing and speed signal input are required to display TT and AIS vectors.

① Press the MENU button.



② Select the "Vector."

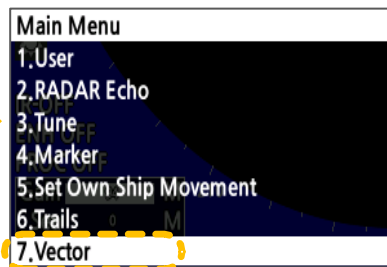

③ Select each menu.

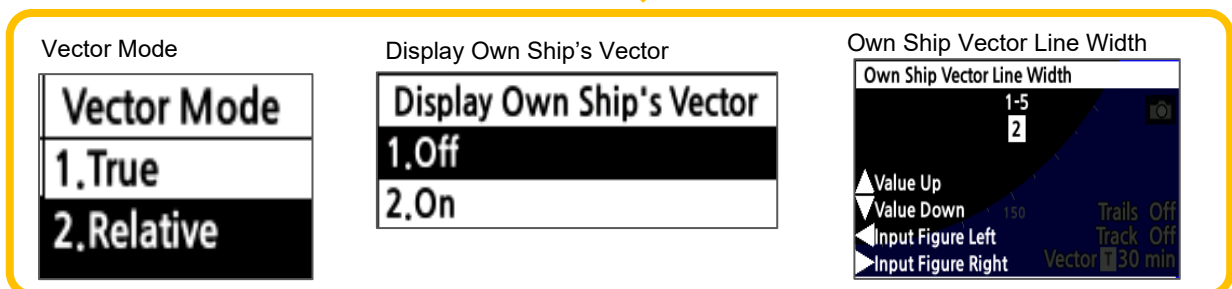
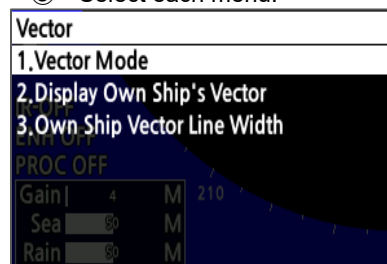

To display the vector, you need to input the direction and speed signal.

### 5.21.1 VECTOR MODE

Set the bearing mode of TT and AIS vectors.

In the True vector mode, the direction of a target vector indicates the true course of the target and its vector length is proportional to its speed. In this mode, the movements of other ships around own ship can be accurately and easily monitored.

The relative vector does not represent the true motion of the target, but its relative relation with own ship. This means that a target with its relative vector directed to own ship will be a dangerous target.

### 5.21.2 DISPLAY OWN SHIP'S VECTOR

Turn on/off own ship vector display.

### 5.21.3 OWN SHIP VECTOR LINE WIDTH

Set the width of own ship vector line.

## 5.22 OFFCENTER SETTING

The display of own ship's position can be moved to any position within 66% of the display radius.

This setting can be unset.

① Press the MENU button.



② Select "Offcenter."

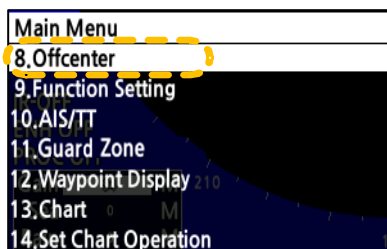

③ Select "Set Position."

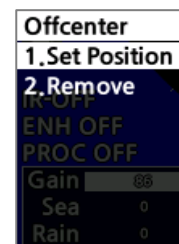

⑤ Operate the cross key or the MULTI control to set the position.

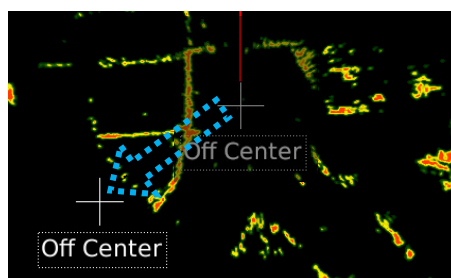

④ Menu display is disappeared and screen display become Set Position mode.

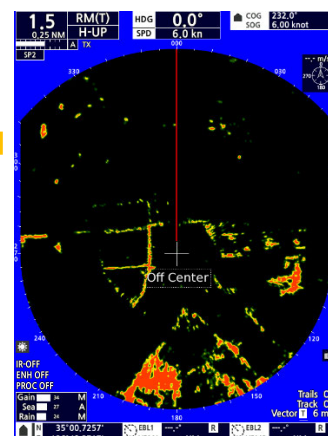

To cancel the position setting, press the CLR button before setting.

⑥ Press the ENT button or the MULTI control, the position is set and the own ship's display position is moved.

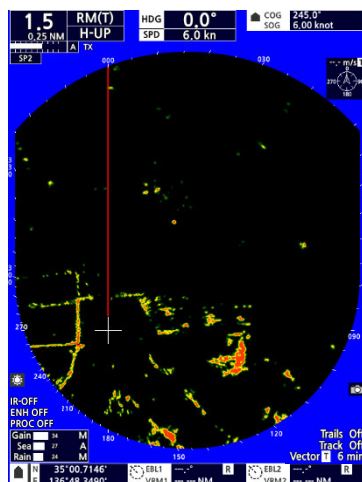

Select "Remove", the set position is cancelled.

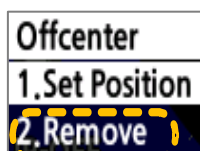

Regardless of own ship motion mode of TM / RM, the display position of own ship will be reset to the center of the screen.

## 5.23 FUNCTION SETTING

“Function Setting” is provided for always obtaining the best radar video by storing complex radar signal processing settings in the optimum status by use, and calling the setting in accordance with the conditions for using the function.

Functions are factory-set for general use, and the settings can be fine adjusted by operating the menu.

You can select one of 6 function modes. The factory presetting is shown below.

- |                      |   |
|----------------------|---|
| Function 1: Standard | Suitable for general monitoring.  |
| Function 2: Coast    | Useful for observing short-range videos.  |
| Function 3: Deepsea  | Suitable for general ocean navigation.  |
| Function 4: Fishnet  | Useful for small target.  |
| Function 5: Bird     | Useful for a flock of seabirds.   |
| Function 6: User     | This mode is for users to save and use their preferred settings, when the 5 modes above are not applicable.<br>The default setting is for a stormy weather. |

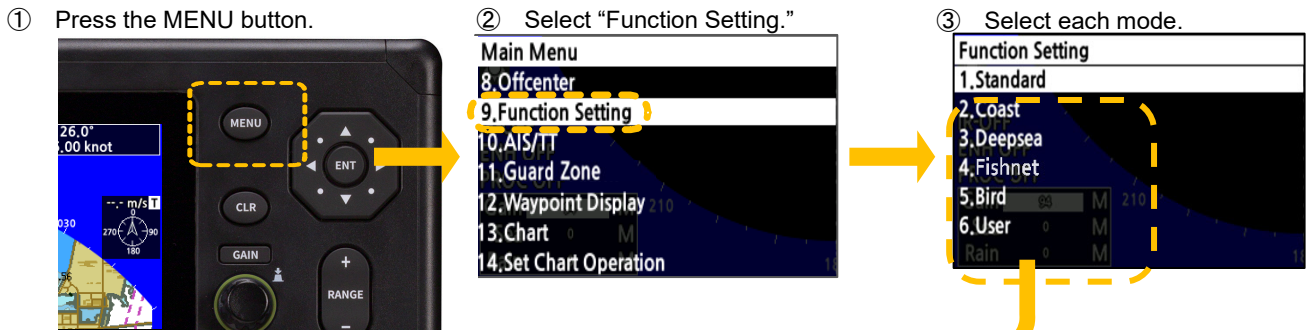

Choose Standard in this example setting.  
There is no difference in setting menu other than Standard.

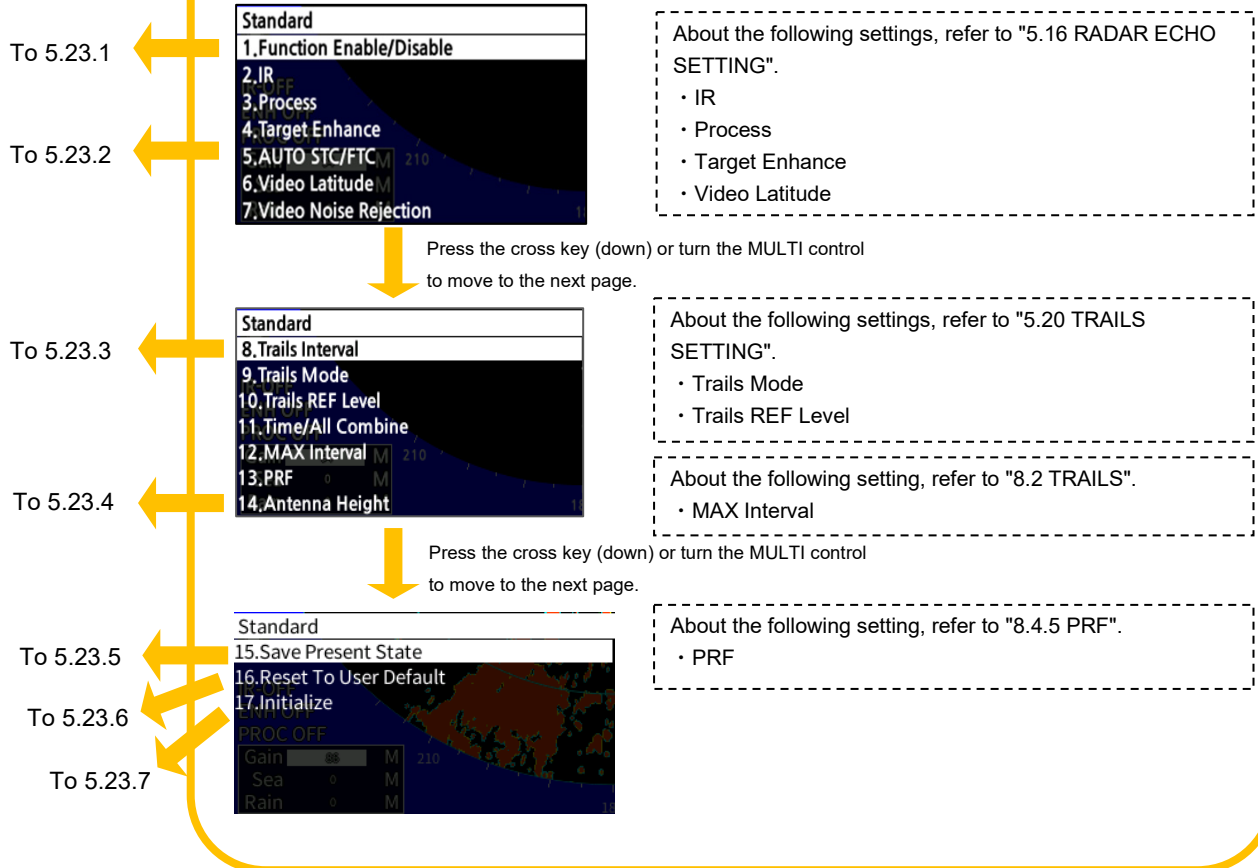

## 5.23.1 FUNCTION ENABLE/DISABLE

Set whether this mode is called when press the FUNC button.

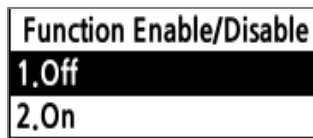

If "Function Enable/Disable" is set to "Off", this mode is not displayed when switching operation mode of the FUNC button.

## 5.23.2 AUTO STC/FTC

Set the auto STC/FTC setting.

Detects unwanted waves such as rain/snow clutter and sea clutter and automatically suppresses them. When the sea state or weather changes, this function automatically performs suppression processing in accordance with the situation.

Suppression processing is not full automatic, and requires the operator to control the afterimages of unwanted waves.

To control the afterimage of sea clutter, use the SEA control.

To control the afterimage of rain/snow clutter, use the RAIN control.

In areas where the density of unwanted waves is low, unwanted waves may remain being judged as targets.

Thus, use the automatic clutter suppression mode together with the video process mode.

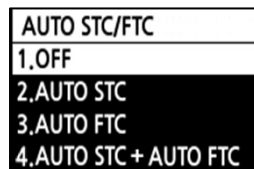

**OFF:** Disable the automatic clutter suppression function.

Select "OFF" when rain/snow clutter and sea clutter are not strong or when the ship is in a bay.

**AUTO STC:** Automatically detects the strength of sea clutter, and performs the most suitable sea clutter suppression processing.

Even when the strength of sea clutter varies depending on the wind direction, AUTO STC performs the most suitable suppression processing.

Land like islands can be displayed naturally.

Since rain clouds outside sea clutter areas are recognized as land, there is no effect of suppressing rain/snow clutter.

Use the RAIN control to set the rain/snow clutter suppression function.

**AUTO FTC:** This function automatically detects the strength of rain/snow clutter, and performs the most suitable rain/snow clutter suppression processing.

Since land is recognized as rain clouds, land videos become obscure.

There is no effect of automatic suppressing sea clutter.

Use the SEA control to set the sea clutter suppression function.

**AUTO STC + AUTO FTC:** This function set both STC and FTC to AUTO.

### 5.23.3 TRAILS INTERVAL

Set the interval of radar trails.

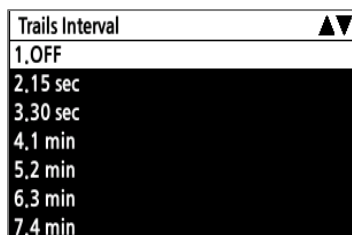

The options in this menu depend on the setting of MAX Interval (refer to “5.23 FUNCTION SETTING”, “8.2 TRAILS”).

If MAX Interval setting is changed, this menu is set the shortest interval in the setting (except “Off”).

### 5.23.4 ANTENNA HEIGHT

Set the antenna height used in the function mode.

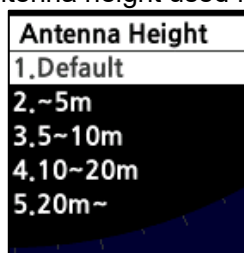

When default is selected, the value set in the Basic Adjustment is applied.

For Basic Adjustment, refer to “7.5 ANTENNA HEIGHT SETUP.”

### 5.23.5 SAVE PRESENT STATE

Not function setting but the current status set in the main menu (for example, “5.16 RADAR ECHO SETTING” and “5.20 TRAILS SETTING”) is saved as the setting value of the selected function mode.

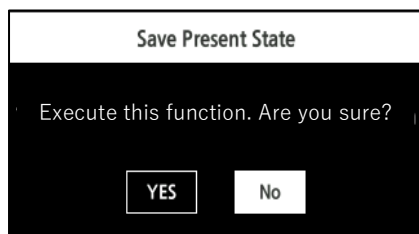

The confirmation dialog window is displayed. Select “YES”, the operation is executed.

### 5.23.6 Reset To User Default

The setting value reset to setting when user executed Table Update (3.Initial Value/2.Function Setting) .

About the Table Update, refer to “8.7.5 TABLE UPDATE.”

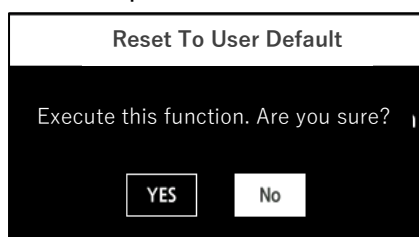

**Hint:** After the radar echo adjustment when installed the radar, recommend executing Table Update. Because your initial setting value is when your radar was installed.

## 5.23.7 INITIALIZE

Initialize a selected function setting mode. The initialized mode values are set to the factory-set values. About the factory-set values of each function setting mode, refer to “5.13 SWITCH THE FUNCTION.”

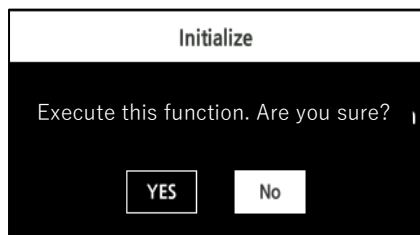

The confirmation dialog window is displayed. Select “YES”, the operation is executed.

## 5.24 AIS/TT

### 5.24.1 COLLISION AVOIDANCE

#### ■ Problems of Collision Avoidance in Navigation

Marine collision avoidance is one of the problems that have been recognized from of old. Now, it will be described briefly who the collision avoidance is positioned among the navigational aid problems.

The navigation pattern of all mobile craft constitutes a system with some closed loops regardless of the media through which the mobile craft travels, whether air, water, the boundary between air and water, or space. This pattern consists of two closed loops in principle, one of which is a collision with another mobile craft and the other is a loop of finding a right and safe way to reach a predeterminate destination.

Fig. 5-24-1 shows the conceptual diagram of navigation pattern by MR. E.W. Anderson. The closed loop of collision avoidance is shown on the left side and the closed loop of finding a right course on the right side.

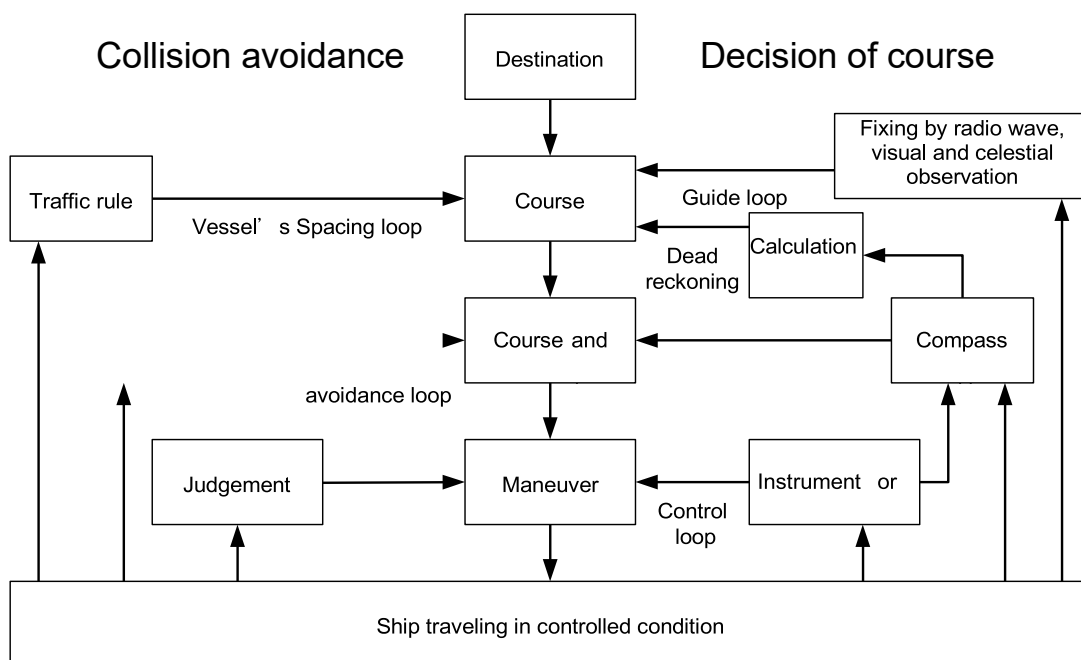

Fig. 5-24-1 Navigation pattern



### ■ Marine Accidents and Collisions

Among marine accidents, collision accidents have been highlighted as the tonnages and speeds of ships become higher along with the increase in traffic at sea.

If a tanker carrying dangerous articles such as crude oil collides with any other vessel, then not only the vessels involved with the accident but other vessels in the vicinity, port facilities, inhabitants in the coastal area as well as marine resources may also suffer immeasurable damages and troubles.

Collision accidents have a high percentage of the marine accidents that have occurred in recent years. To cope with these problems, any effective measures are needed and some equipment to achieve collision avoidance requirements have been developed at rapid strides.

### ■ Basic Concept of Collision Avoidance

There are two aspects in collision avoidance: collision prediction and avoidance. Collision prediction is to predict that two or more vessels will happen to occupy the same point at the same time, while collision avoidance is to maneuver vessels not to occupy the same point at the same time.

In practical operation of vessels, a spot of collision has to be deemed to be a single point but a closed zone. This closed zone is conceptually defined as a CPA (Closest Point of Approach). In collision prediction, the time to be taken until a ship reaches the CPA is defined as a TCPA (Time to CPA). Fig. 5-24-2 shows a diagram called "Collision Triangle".

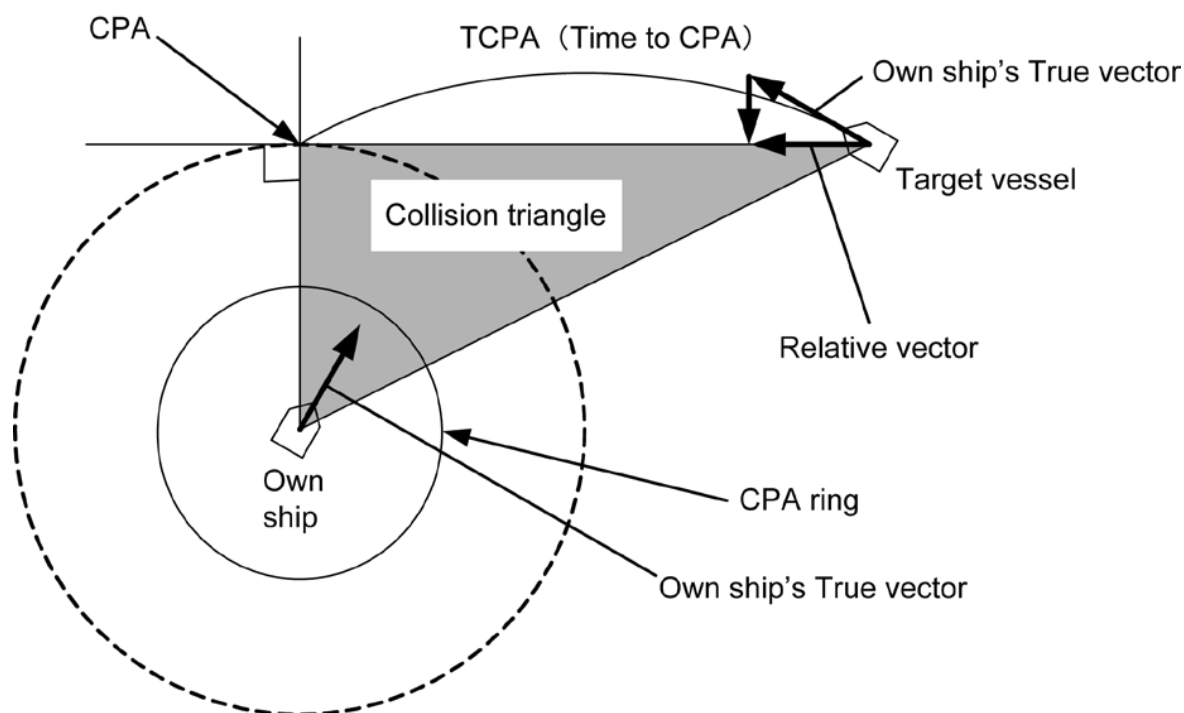

Fig. 5-24-2 Collision Triangle

■ Relative Vector and True Vector

From two points of view, collision prediction and avoidance, it is necessary to obtain the relative vector of other ship for prediction and the true vector of other ship for collision avoidance in order to grasp other ship's aspect.

The relationship between the relative vector and true vector is shown in Fig. 5-24-3. Furthermore, the meanings of both vectors are described.

Both rough CPA and TCPA can be obtained easily from the relative speed vector of other ship. This method has an advantage that the risks of collision with all other ships within the radar range can be seen at a glance. On the other hand, the course and speed of other ship can easily be obtained from its true speed vector, enabling other ship's aspect to be seen at a glance. Thus, the aspects of other ships (transverse, out sail, parallel run, reverse run, etc. ) as described in the act of prevention of collision at sea can be readily grasped. If there is a risk of collision with other ship, the operator can determine which rule to be applied and how to operate own ship.

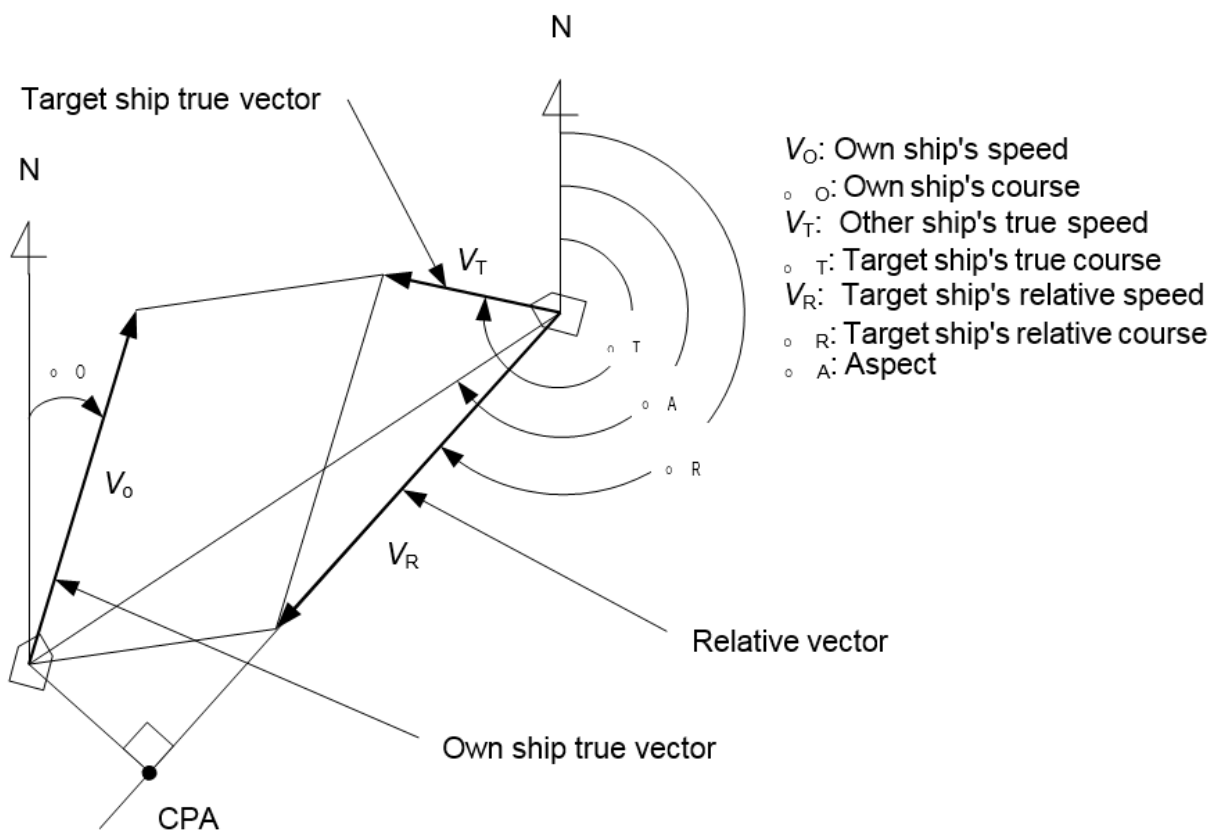

Fig. 5-24-3 Relative Vector and True Vector

■ Radar and Collision Avoidance

Radar is still playing an important roll for collision prevention and positioning.

A plotter is used to further enhance the radar functionality. The plotter is capable of plotting other positions of other ships in 3 to 6 minute intervals to monitor their movement. The plots of other ships represent their tracks relative to own ship, and it is shown whether there is a risk of collision, namely CPA and TCPA can be obtained. This method using a plotter is fairly effective, but the number of target ship, which are manually plotted, is limited and it takes several minutes to measure those.

It is used when you want to set about function of target tracking function (TT) and AIS.

① Press the MENU button.



② Select "AIS/TT."

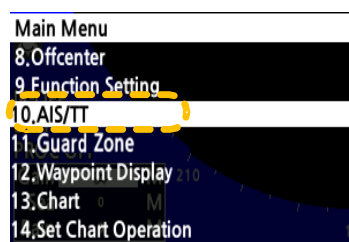

③ Select each menu.

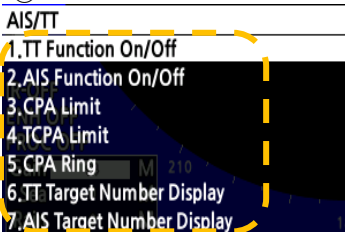

Press the cross key (down) or turn the MULTI control to move to the next page.

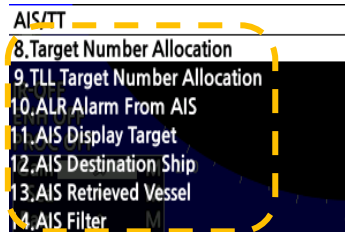

<p>TT Function On/Off AIS Function On/Off</p>	<p>Target Number Display TT</p>	<p>AIS Display Target</p>
<p>CPA Limit</p>	<p>Target Number Display AIS</p>	<p>AIS Destination Ship</p>
<p>TCPA Limit</p>	<p>Target Number Allocation</p>	<p>AIS Retrieved Vessel</p>
<p>CPA Ring</p>	<p>TLL Target Number Allocation</p>	<p>AIS Filter</p>
	<p>ALR Alarm From AIS</p>	

For details about each function, see 5.24.2 ~ 5.24.13

## 5.24.2 FUNCTION ON/OFF

Turn on/off the function of TT and AIS.

## 5.24.3 CPA LIMIT

Set the distance to CPA (Closest Point of Approach). Use the cross key or the MULTI control to change the value.

The CPA limit value can be set 0.0 NM or between 0.1 and 9.9 NM.

**Note:**

If "CPA" is set to 0.0NM, TT (CPA/TCPA) alarm will not be generated.

The TT (CPA/TCPA) alarm is an alarm that can be generated only with the TT function, and does not generate an alarm with the AIS function.

## 5.24.4 TCPA LIMIT

Set the distance to TCPA (Time to CPA). Use the cross key or the MULTI control to change the value.

The TCPA limit value can be set 0min or between 1 and 99 min.

**Note:**

If "TCPA" is set to 0 min, TT (CPA/TCPA) alarm will not be generated.

The TT (CPA/TCPA) alarm is an alarm that can be generated only with the TT function, and does not generate an alarm with the AIS function.

## 5.24.5 CPA RING

Set the display of CPA ring. While the distance of the specified CPA Limit value is used as the radius, the CPA ring is displayed with a white circle of which center is the own ship's position.

The CPA ring is not displayed when the true vector mode is selected.

## 5.24.6 TARGET NUMBER DISPLAY

A target ID number is a value displayed beside the target symbol or AIS symbol. These numbers are assigned to targets in acquisition order automatically. The start number can be specified by "Target Number Allocation" (see "5.24.7 TARGET NUMBER ALLOCATION"). Each target is identified by the assigned ID number until it is lost or its acquisition is canceled.

Turn on/off the number of tracking target and AIS symbol.

An ID number is always displayed for only targets with which numeric data is displayed.

### 5.24.7 TARGET NUMBER ALLOCATION

The start number of targets can be specified for the target symbol or AIS symbol. Use the cross key or the MULTI control to change the value.

The start numbers of TT and AIS target can be specified respectively.

The start number of TT can be set between 0 and 70.

The start number of AIS can be set between 100 and 900.

### 5.24.8 TLL TARGET NUMBER ALLOCATION

Select the position that it output as the position of the TLL sentence. The position can be selected from own ship's position or the cursor position.

The target number for TLL sentence can be specified.

### 5.24.9 ALR ALARM FROM AIS

Set the display of NMEA ALR sentence received from AIS.

### 5.24.10 AIS DISPLAY TARGET

Set the number of AIS display targets. Set this to get a better look at the screen by limiting the number of AIS symbols.

### 5.24.11 AIS DESTINATION SHIP

Set the MMSI of the AIS destination ship.

Use the cross key or the MULTI control to change the value.

The AIS destination ship is connected ownship with straight dotted line.

If unsetting the AIS destination ship, input "0."

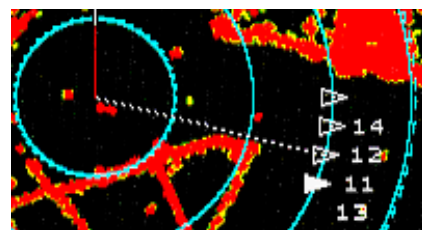

### 5.24.12 AIS RETRIEVED VESSEL

Set the MMSI of the AIS retrieved vessel.

Use the cross key or the MULTI control to change the value.

AIS retrieved vessel can be set up to 10 vessels.

The AIS symbol that is set AIS retrieved vessel is filled.

If unsetting the AIS retrieved vessel, input "0."

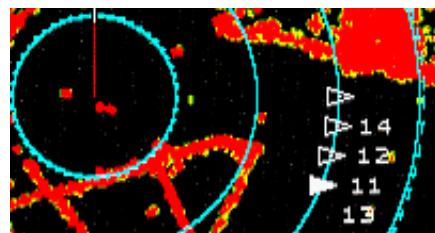

Hint: You can set AIS destination ship and retrieved vessel at the same time. The AIS symbol become to fill and connect with straight line.

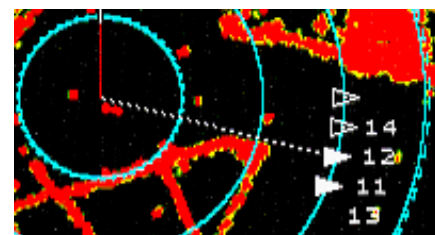

### 5.24.13 AIS FILTER

Set the range of AIS filter. Use the cross key or the MULTI control to change the value.

## 5.25 GUARD ZONE

This function sounds an alarm by detecting the movement of the target in the created zone. Two fan-shaped zones can be created. Zone alarm level and mode can be set for each zone. The automatic acquisition function (Auto TT) can be set to the zone.

**Note:**

The guard zone for which the Auto TT function can be set is only zone 1. An alarm function other than the Auto TT function can be set in zone 2.

① Press the MENU button.



② Select "Guard Zone."

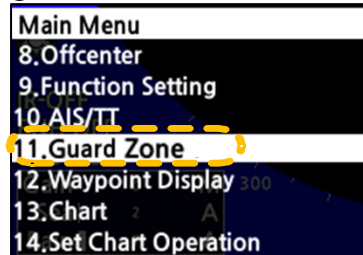

③ Select each menu.

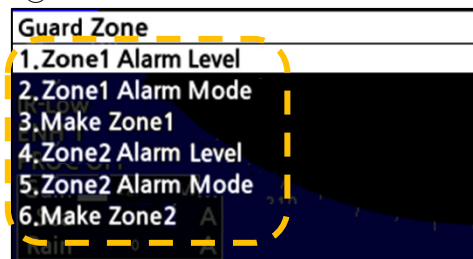

Zone Alarm Level	Zone Mode
<b>Zone1 Alarm Level</b>	<b>Zone1 Alarm Mode</b>
1. Level1	1. OFF
2. Level2	2. Display
3. Level3	3. In
4. Level4	4. Out
	5. AutoTT

Each Zone 2 setting menu is the same as Zone 1.

### 5.25.1 ZONE ALARM LEVEL

Detection levels of guard zone can be set to issue alarms.

Detection level can be set between 1 and 4. When setting to lower level of detection, the alarm operates for weaker targets. When setting to higher level of detection, be careful because the alarm may not operate properly.

- "Zone 1 Alarm Level" is setting for guard zone 1.
- "Zone 2 Alarm Level" is setting for guard zone 2.

### 5.25.2 ZONE MODE

**Note:**

The guard zone for which the Auto TT function can be set is only zone 1. An alarm function other than the Auto TT function can be set in zone 2.

Set the mode of guard zone.

OFF: Function OFF.

Display: Show the zone that you set. The alarm does not sound.

In: When a target entered the set zone, the alarm sounds.

Out: When a target went out of the set zone, the alarm sounds.

Auto TT: Target tracking automatically.

### 5.25.3 MAKE ZONE

Make the guard zone.

The mode of the zone is "Display" while making zone.



After you selected Make Zone1 or Make Zone2, appear "Guard Zone" below the cursor. This means in make zone mode.

Procedure 1: Adjust to move ① side toward bearing by Multi. Press Multi and decide position.

2: Adjust to move ② side toward bearing by Multi. Press Multi and decide position.

3: Adjust to move ③ side toward range by Multi. Press Multi and decide position.

4: Adjust to move ④ side toward range by Multi. Press Multi and decide position.

At the same time, the display of "Guard Zone" disappear and finish.

If you could not draw the guard zoon as you want, please one more time above procedure.

## 5.26 WAYPOINT DISPLAY

When waypoint information is received from the navigation equipment, the waypoint mark appears on the radar display.

Set the display on/off.

- ① Press the MENU button to open the Main Menu.

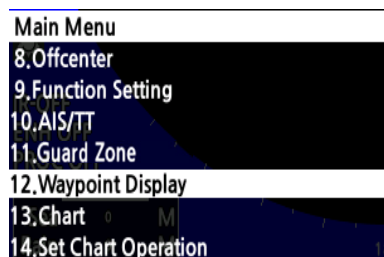

- ② Select "Waypoint Display."

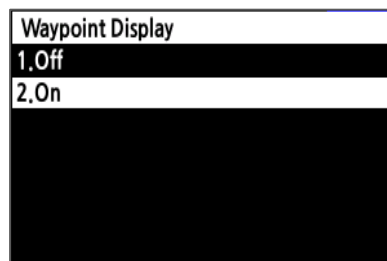

When the function is turned on, the waypoint mark is displayed on the radar screen as red circle. It is connected Onwship and a Waypoint with a straight red line.

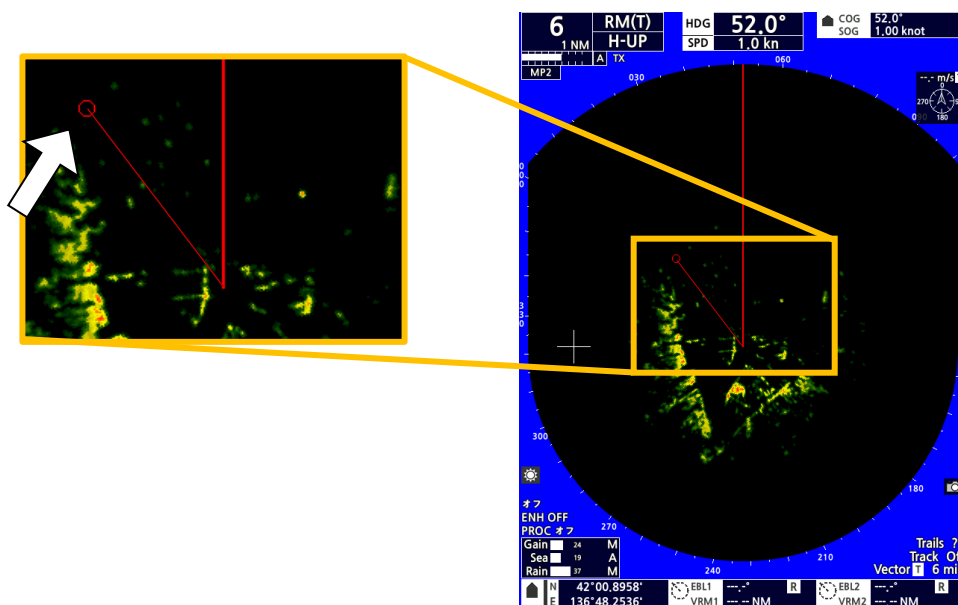



## 5.27 CHART

Set the display of chart.

To display the chart, need to insert chart card into SD card slot on the equipment beforehand.

① Press the MENU button.



② Select "Chart."

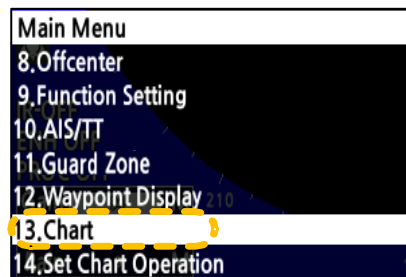

### Note:

In case of Navionics+, it can not use "3.Symbol" and "5.Show extend Data".

Because Navionics+ is inseparable chart data structure at present.

③ Select each menu.

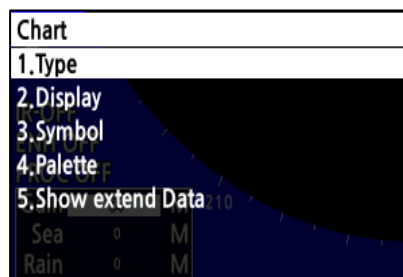

<p>Display</p> <table border="1"> <tbody> <tr> <td><b>Display</b></td> </tr> <tr> <td>1.Off</td> </tr> <tr> <td>2.On</td> </tr> </tbody> </table>	<b>Display</b>	1.Off	2.On	<p>Type</p> <table border="1"> <tbody> <tr> <td><b>Type</b></td> </tr> <tr> <td>1.new pec</td> </tr> <tr> <td>2.Navionics+</td> </tr> </tbody> </table>	<b>Type</b>	1.new pec	2.Navionics+	<p>Symbol</p> <table border="1"> <tbody> <tr> <td><b>Symbol</b></td> </tr> <tr> <td>1.Lat/Lon grid</td> </tr> <tr> <td>2.Depth Grid</td> </tr> <tr> <td>3.Lighthouse</td> </tr> <tr> <td>4.Buoy</td> </tr> <tr> <td>5.Wreck Ship</td> </tr> <tr> <td>6.Fish Haven</td> </tr> <tr> <td>7.Sea Lane</td> </tr> </tbody> </table>	<b>Symbol</b>	1.Lat/Lon grid	2.Depth Grid	3.Lighthouse	4.Buoy	5.Wreck Ship	6.Fish Haven	7.Sea Lane
<b>Display</b>																
1.Off																
2.On																
<b>Type</b>																
1.new pec																
2.Navionics+																
<b>Symbol</b>																
1.Lat/Lon grid																
2.Depth Grid																
3.Lighthouse																
4.Buoy																
5.Wreck Ship																
6.Fish Haven																
7.Sea Lane																
<p>Palette</p> <table border="1"> <tbody> <tr> <td><b>Palette</b></td> </tr> <tr> <td>1.Day</td> </tr> <tr> <td>2.Night</td> </tr> <tr> <td>3.Day-Black Sea</td> </tr> </tbody> </table>	<b>Palette</b>	1.Day	2.Night	3.Day-Black Sea	<p>Show extend Data</p> <table border="1"> <tbody> <tr> <td><b>Show extend Data</b></td> </tr> <tr> <td>1.Off</td> </tr> <tr> <td>2.On</td> </tr> </tbody> </table>	<b>Show extend Data</b>	1.Off	2.On								
<b>Palette</b>																
1.Day																
2.Night																
3.Day-Black Sea																
<b>Show extend Data</b>																
1.Off																
2.On																

### 5.27.1 TYPE

Select the kind of chart displayed from new pec or Navionics+.

## 5.27.2 DISPLAY

Select the chart display on/off.

## 5.27.3 SYMBOL

**Note: This function for only new pec. Navionics+ is not supported.**

Select the chart symbol display on/off.

The symbols which can be selected the display on/off are in following list.

Symbol	Default Setting
Lat/Lon grid	Off
Depth Grid	Off
Lighthouse	Off
Buoy	Off
Wreck Ship	Off
Fish Haven	Off
Sea Lane	Off
Restricted Area	Off
Fishing Area	Off
Sea Cable	Off
Name	Off
Mark Attribute	Off
etc. (For example, Tide Station)	Off

Display of depth grid depends on range scale setting, so it is thinned out.

To display all, set "Show extend Data (5.27.5)."

## 5.27.4 PALETTE

Set the display color of chart.

## 5.27.5 SHOW EXTEND DATA

**Note: This function for only new pec. Navionics+ is not supported.**

Set to display of depth grid all regardless of range scale setting.

## 5.28 SET CHART OPERATION

Select the operation of “Delete Chart/Echo Temporarily” in “Set Operation.”

To perform this setting operation, the chart card is required.

① Press the MENU button.



② Select “Set Chart Operation.”

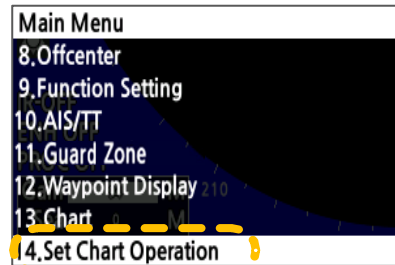

③ Select each menu.

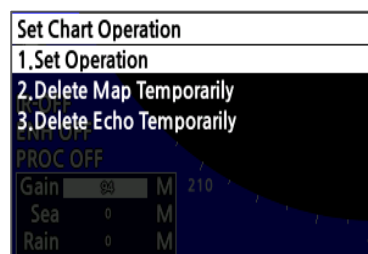

Set Operation menu	Screen display while “Delete Chart Temporarily”	Screen display while “Delete Echo Temporarily”				
<table border="1"> <thead> <tr> <th>Set Operation</th> </tr> </thead> <tbody> <tr> <td>1. Press 1 time, recover 3 seconds later</td> </tr> <tr> <td>2. Press once, delete mutual</td> </tr> <tr> <td>3. Press 1 time, recover 8 seconds later</td> </tr> </tbody> </table>	Set Operation	1. Press 1 time, recover 3 seconds later	2. Press once, delete mutual	3. Press 1 time, recover 8 seconds later		
Set Operation						
1. Press 1 time, recover 3 seconds later						
2. Press once, delete mutual						
3. Press 1 time, recover 8 seconds later						

Press 1 time, recover 3 seconds later: Performing “Delete Chart Temporarily” while select the mode, chart is disappeared for 3 seconds and displayed again.

Performing “Delete Echo Temporarily” while select the mode, radar echo image is disappeared for 3 seconds and displayed again.

Press once, delete mutual: Chart and radar echo image are disappeared mutually.

Performing “Delete Chart Temporarily” while select the mode, chart is disappeared for 3 seconds. Radar echo image is also disappeared for 3 seconds after chart is displayed again. After that, both chart and radar echo are displayed.

Performing “Delete Echo Temporarily” while select the mode, Radar echo image is disappeared for 3 seconds. Chart is also disappeared for 3 seconds after radar echo image is displayed again. After that, both chart and radar echo are displayed.

Press 1 time, recover 8 seconds later: Performing “Delete Chart Temporarily” while select the mode, chart is disappeared for 8 seconds and displayed again.  
 Performing “Delete Echo Temporarily” while select the mode, radar echo image is disappeared for 8 seconds and displayed again.

## 5.29 MARK SETTING

Set the size, color and type for marks (about the mark function, see “5.9 MARK”).  
 Only marks of a specific color or type can be displayed.

① Press the MENU button.



② Select “Mark.”

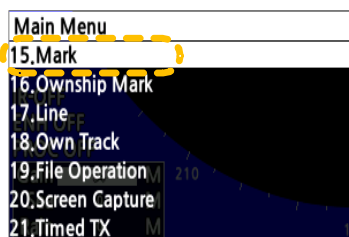

③ Select each menu.



If “Mark List” is selected, the list of marks is open. See 5.29.6

<p>Mark Size</p>	<p>Mark Color</p>	<p>Mark Type</p>	<p>Display Mark Color/Type (This image is Display Mark Type)</p>
------------------	-------------------	------------------	--

To  
 5.29.4  
 5.29.5

### 5.29.1 MARK SIZE

Select the size of mark.

### 5.29.2 MARK COLOR

Select the color of mark.

The color of mark can be selected from following 7 colors.

White/Cyan/Blue/Green/Yellow/Pink/Red

### 5.29.3 MARK TYPE

Select the type of mark.

The type of mark can be selected from ×, +, Y or ☒

### 5.29.4 DISPLAY MARK COLOR

Display the marks with the specified color.

When “All” is set to All, the setting of “All” is prior to individual settings.

When “All” is set to Individual, individual settings are prior to the setting of “All.”

### 5.29.5 DISPLAY MARK TYPE

Display the marks with the specified type.

When “All” is set to All, the setting of “All” is prior to individual settings.

When “All” is set to Individual, individual settings are prior to the setting of “All.”

### 5.29.6 MARK LIST

Display the list of marks which are on the radar screen.

Num	Shape	Color	Latitude	Longitude
001	+	Cyan	N035°23.0081'	E139°46.8425'
002	X	White	N035°22.9005'	E139°46.9634'
003	Y	Blue	N035°22.6058'	E139°47.2774'

■ The mark can be created or modified by operating on the list.

#### Procedure for creating new mark

1. Press the GAIN control.
2. The dialog as below is displayed.

Mark List	
1.Number	1
2.Mark Type	x
3.Mark Color	White
4.Latitude	N 00°00.0000'
5.Longitude	E 000°00.0000'
6.Enter	

3. Input the No.2 to No.5 items.
4. Select No.6 “Enter”, the mark can be created.

**Procedure for modifying a mark**

1. Press the cross key (up/down) or turn the MULTI control, move the focus on the mark to be modified.
2. Press the SEA control.
3. The dialog as below is displayed.

Mark List	
1.Number	1
2.Mark Type	x
3.Mark Color	White
4.Latitude	N 00° 00.0000'
5.Longitude	E 000° 00.0000'
6.Enter	

4. Input the No.2 to No.5 items.
5. Select No.6 "Enter", the mark can be modified.

■ The marks can be deleted by operating on the list.

**Procedure for individual deletion**

1. Press the cross key (up/down) or turn the MULTI control to move the focus.
2. Press the RAIN control.
3. The selected mark is deleted.

All the marks can be deleted at once.

**Procedure for deleting all**

1. Press the BRILL control.
2. The following delete confirmation is displayed.  
Select YES to delete.

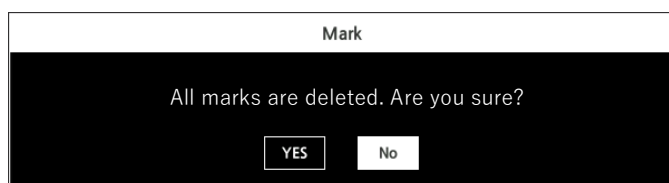

3. All the marks are deleted.

## 5.30 OWNSHIP MARK SETTING

Set the size, colors and types for ownship marks (about the ownship mark function, see “5.11 OWNSHIP MARK”).

Only ownship marks of a specific color or type can be displayed.

① Press the MENU button.



② Select “Ownship Mark.”

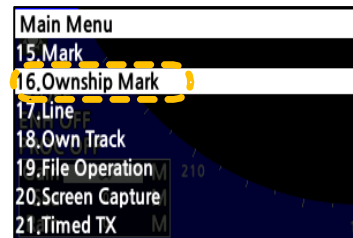

③ Select each menu.



<p>Own Ship Position Mark Size</p>	<p>Own Ship Position Mark Color</p>	<p>Display Mark Color</p>
<p>Display Mark Type</p>	<p>Own Ship Position Mark Type</p>	<p>Own Ship Position Mark List</p>

### 5.30.1 OWN SHIP POSITION MARK SIZE

Select the size of mark.

### 5.30.2 OWN SHIP POSITION MARK COLOR

Select the color of mark.

The color of mark can be selected from following 7 colors.

White/Cyan/Blue/Green/Yellow/Pink/Red

### 5.30.3 OWN SHIP POSITION MARK TYPE

Select the type of mark.

The type of mark can be selected from ×, +, Y or ☒

### 5.30.4 DISPLAY MARK COLOR

Display the marks with the specified color.

When “All” is set to All, the setting of “All” is prior to individual settings.

When “All” is set to Individual, individual settings are prior to the setting of “All.”

### 5.30.5 DISPLAY MARK TYPE

Display the marks with the specified type.

When “All” is set to All, the setting of “All” is prior to individual settings.

When “All” is set to Individual, individual settings are prior to the setting of “All.”

### 5.30.6 OWN SHIP POSITION MARK LIST

Display the list of the ownship marks which are on the radar screen.

Num	Shape	Color	Latitude	Longitude
001	X	Orange	N035°22.9108'	E139°48.2889'
002	+	Purple	N035°22.9176'	E139°48.2989'
003	Y	Red	N035°22.9223'	E139°48.3057'

■ The ownship mark can be created or modified by operating on the list.

#### Procedure for creating new mark

1. Press the GAIN control.
2. The dialog as below is displayed.

Mark List	
1.Number	1
2.Mark Type	×
3.Mark Color	White
4.Latitude	N 35°00.8049'
5.Longitude	E 136°48.2000'
6.Enter	

3. Input the No.2 to No.5 items.
4. Select No.6 “Enter”, the ownship mark can be created.



**Procedure for modifying a mark**

1. Press the cross key (up/down) or turn the MULTI control, move the focus on the mark to be modified.
2. Press the SEA control.
3. The dialog as below is displayed.

Mark List	
1.Number	1
2.Mark Type	x
3.Mark Color	White
4.Latitude	N 35°00.8049'
5.Longitude	E 136°48.2000'
6.Enter	

4. Input the No.2 to No.5 items.
5. Select No.6 "Enter", the ownship mark can be modified.

■ The ownship marks can be deleted by operating on the list.

**Procedure for individual deletion**

1. Press the cross key (up/down) or turn the MULTI control to move the focus.
2. Press the RAIN control.
3. The selected ownship mark is deleted.

All the ownship marks can be deleted at once.

**Procedure for deleting all**

1. Press the BRILL control.
2. The following delete confirmation is displayed.  
Select YES to delete.



3. All the ownship marks are deleted.

## 5.31 LINE SETTING

Set the colors and types for lines (about the line function, see “5.10 LINE”).  
Only lines of a specific color or type can be displayed.

① Press the MENU button.



② Select “Line”.

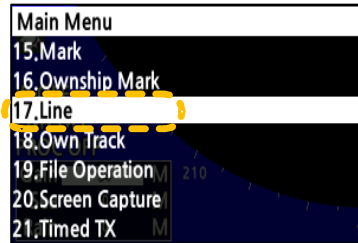

③ Select each menu.



Line Color	Line Type	Display Line Color	Display Line Type	Line List																																																													
<table border="1"> <thead> <tr> <th>Line Color</th> </tr> </thead> <tbody> <tr><td>1.White</td></tr> <tr><td>2.Cyan</td></tr> <tr><td>3.Blue</td></tr> <tr><td>4.Green</td></tr> <tr><td>5.Yellow</td></tr> <tr><td>6.Pink</td></tr> <tr><td>7.Red</td></tr> </tbody> </table>	Line Color	1.White	2.Cyan	3.Blue	4.Green	5.Yellow	6.Pink	7.Red	<table border="1"> <thead> <tr> <th>Line Type</th> </tr> </thead> <tbody> <tr><td>1. —————</td></tr> <tr><td>2. - - - - -</td></tr> <tr><td>3. - - - - -</td></tr> </tbody> </table>	Line Type	1. —————	2. - - - - -	3. - - - - -	<table border="1"> <thead> <tr> <th>Display Line Color</th> </tr> </thead> <tbody> <tr><td>1.All</td></tr> <tr><td>2.White</td></tr> <tr><td>3.Cyan</td></tr> <tr><td>4.Blue</td></tr> <tr><td>5.Green</td></tr> <tr><td>6.Yellow</td></tr> <tr><td>7.Pink</td></tr> </tbody> </table>	Display Line Color	1.All	2.White	3.Cyan	4.Blue	5.Green	6.Yellow	7.Pink	<table border="1"> <thead> <tr> <th>Display Line Type</th> </tr> </thead> <tbody> <tr><td>1.All</td></tr> <tr><td>2. —————</td></tr> <tr><td>3. - - - - -</td></tr> <tr><td>4. - - - - -</td></tr> </tbody> </table>	Display Line Type	1.All	2. —————	3. - - - - -	4. - - - - -	<table border="1"> <thead> <tr> <th>Line List</th> </tr> </thead> <tbody> <tr> <td>Item</td> <td>Shape</td> <td>Color</td> <td>Latitude</td> <td>Longitude</td> </tr> <tr> <td>001</td> <td>○</td> <td></td> <td>N035°22.2152'</td> <td>E139°48.0131'</td> </tr> <tr> <td>002</td> <td>○</td> <td></td> <td>N035°22.0676'</td> <td>E139°47.9611'</td> </tr> <tr> <td>003</td> <td>○</td> <td></td> <td>N035°22.0922'</td> <td>E139°47.9479'</td> </tr> <tr> <td>004</td> <td>○</td> <td></td> <td>N035°22.0853'</td> <td>E139°47.9478'</td> </tr> <tr> <td>005</td> <td>○</td> <td></td> <td>N035°22.2184'</td> <td>E139°47.7838'</td> </tr> <tr> <td>006</td> <td>○</td> <td></td> <td>N035°22.6725'</td> <td>E139°47.7531'</td> </tr> </tbody> </table>	Line List	Item	Shape	Color	Latitude	Longitude	001	○		N035°22.2152'	E139°48.0131'	002	○		N035°22.0676'	E139°47.9611'	003	○		N035°22.0922'	E139°47.9479'	004	○		N035°22.0853'	E139°47.9478'	005	○		N035°22.2184'	E139°47.7838'	006	○		N035°22.6725'	E139°47.7531'
Line Color																																																																	
1.White																																																																	
2.Cyan																																																																	
3.Blue																																																																	
4.Green																																																																	
5.Yellow																																																																	
6.Pink																																																																	
7.Red																																																																	
Line Type																																																																	
1. —————																																																																	
2. - - - - -																																																																	
3. - - - - -																																																																	
Display Line Color																																																																	
1.All																																																																	
2.White																																																																	
3.Cyan																																																																	
4.Blue																																																																	
5.Green																																																																	
6.Yellow																																																																	
7.Pink																																																																	
Display Line Type																																																																	
1.All																																																																	
2. —————																																																																	
3. - - - - -																																																																	
4. - - - - -																																																																	
Line List																																																																	
Item	Shape	Color	Latitude	Longitude																																																													
001	○		N035°22.2152'	E139°48.0131'																																																													
002	○		N035°22.0676'	E139°47.9611'																																																													
003	○		N035°22.0922'	E139°47.9479'																																																													
004	○		N035°22.0853'	E139°47.9478'																																																													
005	○		N035°22.2184'	E139°47.7838'																																																													
006	○		N035°22.6725'	E139°47.7531'																																																													

### 5.31.1 LINE COLOR

Select the color of line.

The color of line can be selected from following 7 colors.

White/Cyan/Blue/Green/Yellow/Pink/Red

### 5.31.2 LINE TYPE

Select the type of line.

The type of line can be selected from Solid Line, Dashed Line (Short) or Dashed line (Long.)

### 5.31.3 DISPLAY LINE COLOR

Display the lines with the specified color.

When “All” is set to All, the setting of “All” is prior to individual settings.

When “All” is set to Individual, individual settings are prior to the setting of “All.”

### 5.31.4 DISPLAY LINE TYPE

Display the lines with the specified type.

When “All” is set to All, the setting of “All” is prior to individual settings.

When “All” is set to Individual, individual settings are prior to the setting of “All.”

### 5.31.5 LINE LIST

Display the list of lines which are on the radar screen.

List(Line)				
Num	Shape	Color	Latitude	Longitude
001			N035°22.0152'	E139°48.0133'
002			N035°22.0676'	E139°47.9611'
003			N035°22.0922'	E139°47.9475'
004			N035°22.0853'	E139°47.8478'
005			N035°22.2184'	E139°47.7838'
006			N035°22.6725'	E139°47.7531'

■ The line vertex can be created or modified by operating on the list.

#### Procedure for creating new line vertex

1. Press the GAIN control.
2. The dialog as below is displayed.

Line List	
1.Number	1
2.Line Type	
3.Line Color	White
4.Latitude	N 00°00.0000'
5.Longitude	E 000°00.0000'
6.Enter	

3. Input the No.2 to No.5 items.
4. Select No.6 “Enter”, the vertex can be created.

**Procedure for modifying a line vertex**

1. Press the cross key (up/down) or turn the MULTI control, move the focus on the vertex to be modified.
2. Press the SEA control.
3. The dialog as below is displayed.

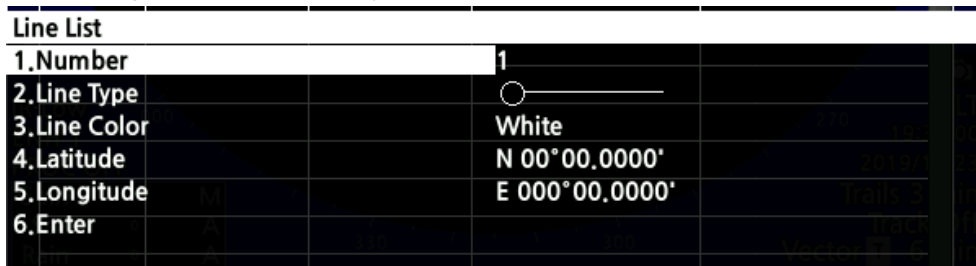

4. Input the No.2 to No.5 items.
5. Select No.6 “Enter”, the vertex can be modified.

■ The lines can be deleted by operating on the list.

**Procedure for individual deletion**

1. Press the cross key (up/down) or turn the MULTI control to move the focus.
2. Press the RAIN control.
3. The selected line vertex is deleted.

All the lines can be deleted at once.

**Procedure for deleting all**

1. Press the BRILL control.
2. The following delete confirmation is displayed.

Select YES to delete.



3. All the lines are deleted.

## 5.32 OWN TRACK SETTING

① Press the MENU button.



② Select "Own Track".

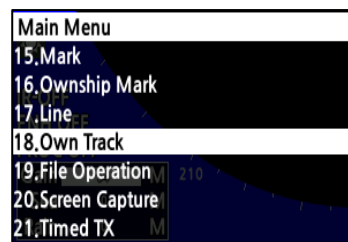

③ Select each menu.

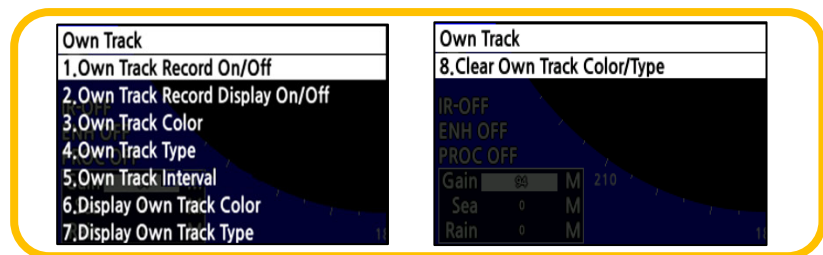

<p>Own Track Record On/Off</p> <table border="1"> <tr><th>Own Track Record On/Off</th></tr> <tr><td>1. Off</td></tr> <tr><td>2. On</td></tr> </table>	Own Track Record On/Off	1. Off	2. On	<p>Own Track Record Display On/Off</p> <table border="1"> <tr><th>Own Track Record Display On/Off</th></tr> <tr><td>1. Off</td></tr> <tr><td>2. On</td></tr> </table>	Own Track Record Display On/Off	1. Off	2. On	<p>Own Track Color</p> <table border="1"> <tr><th>Own Track Color</th></tr> <tr><td>1. White</td></tr> <tr><td>2. Cyan</td></tr> <tr><td>3. Blue</td></tr> <tr><td>4. Green</td></tr> <tr><td>5. Yellow</td></tr> <tr><td>6. Pink</td></tr> <tr><td>7. Red</td></tr> </table>	Own Track Color	1. White	2. Cyan	3. Blue	4. Green	5. Yellow	6. Pink	7. Red	<p>Own Track Type</p> <table border="1"> <tr><th>Own Track Type</th></tr> <tr><td>1. _____</td></tr> <tr><td>2. - - - - -</td></tr> <tr><td>3. - - - - -</td></tr> </table>	Own Track Type	1. _____	2. - - - - -	3. - - - - -							
Own Track Record On/Off																												
1. Off																												
2. On																												
Own Track Record Display On/Off																												
1. Off																												
2. On																												
Own Track Color																												
1. White																												
2. Cyan																												
3. Blue																												
4. Green																												
5. Yellow																												
6. Pink																												
7. Red																												
Own Track Type																												
1. _____																												
2. - - - - -																												
3. - - - - -																												
<p>Own Track Interval</p> <table border="1"> <tr><th>Own Track Interval</th></tr> <tr><td>1. 3Seconds</td></tr> <tr><td>2. 5Seconds</td></tr> <tr><td>3. 10Seconds</td></tr> <tr><td>4. 30Seconds</td></tr> <tr><td>5. 1Minutes</td></tr> <tr><td>6. 3Minutes</td></tr> <tr><td>7. 5Minutes</td></tr> </table>	Own Track Interval	1. 3Seconds	2. 5Seconds	3. 10Seconds	4. 30Seconds	5. 1Minutes	6. 3Minutes	7. 5Minutes	<p>Display Own Track Color</p> <table border="1"> <tr><th>Display Own Track Color</th></tr> <tr><td>1. All</td></tr> <tr><td>2. White</td></tr> <tr><td>3. Cyan</td></tr> <tr><td>4. Blue</td></tr> <tr><td>5. Green</td></tr> <tr><td>6. Yellow</td></tr> <tr><td>7. Pink</td></tr> </table>	Display Own Track Color	1. All	2. White	3. Cyan	4. Blue	5. Green	6. Yellow	7. Pink	<p>Display Own Track Type</p> <table border="1"> <tr><th>Display Own Track Type</th></tr> <tr><td>1. All</td></tr> <tr><td>2. _____</td></tr> <tr><td>3. - - - - -</td></tr> <tr><td>4. - - - - -</td></tr> </table>	Display Own Track Type	1. All	2. _____	3. - - - - -	4. - - - - -	<p>Clear Own Track Color/Type</p> <table border="1"> <tr><th>Clear Own Track Color/Type</th></tr> <tr><td>1. Clear Own Track Color</td></tr> <tr><td>2. Clear Own Track Type</td></tr> <tr><td>3. Clear Own Track</td></tr> </table>	Clear Own Track Color/Type	1. Clear Own Track Color	2. Clear Own Track Type	3. Clear Own Track
Own Track Interval																												
1. 3Seconds																												
2. 5Seconds																												
3. 10Seconds																												
4. 30Seconds																												
5. 1Minutes																												
6. 3Minutes																												
7. 5Minutes																												
Display Own Track Color																												
1. All																												
2. White																												
3. Cyan																												
4. Blue																												
5. Green																												
6. Yellow																												
7. Pink																												
Display Own Track Type																												
1. All																												
2. _____																												
3. - - - - -																												
4. - - - - -																												
Clear Own Track Color/Type																												
1. Clear Own Track Color																												
2. Clear Own Track Type																												
3. Clear Own Track																												

### 5.32.1 OWN TRACK RECORD ON/OFF

Turn on/off own track record function.

When this function is turned off, recording own track is stopped.

### 5.32.2 OWN TRACK RECORD DISPLAY ON/OFF

Display own track on/off.

When this function is turned on, own track display depends on settings of "Display Own Track Color" and "Display Own Track Type."

Own track is recorded while this function is turned off.

### 5.32.3 OWN TRACK COLOR

Select the color of own track line.

Own track line color can be selected from following 7 colors.

White/Cyan/Blue/Green/Yellow/Pink/Red

### 5.32.4 OWN TRACK TYPE

Select the type of own track line.

Own track line type can be selected from Solid Line, Dashed Line (Short) or Dashed line (Long).

### 5.32.5 OWN TRACK INTERVAL

The storage interval of the own ship's track is changed.

A preset time interval or preset distance interval can be selected as the storage interval. The distance setting varies depending on the range scale unit setting.

### 5.32.6 DISPLAY OWN TRACK COLOR

Display the line of own ship's track with the specified color.

When "All" is set to All, the setting of "All" is prior to individual settings.

When "All" is set to Individual, individual settings are prior to the setting of "All."

### 5.32.7 DISPLAY OWN TRACK TYPE

Display the line of own ship's track with the specified type.

When "All" is set to All, the setting of "All" is prior to individual settings.

When "All" is set to Individual, individual settings are prior to the setting of "All."

### 5.32.8 CLEAR OWN TRACK COLOR/TYPE

Clear the line of own ship's track.

Select color and type to clear in "Clear Own Track Color" and "Clear Own Track Type."

Execute "Clear Own Track", the own ship's track lines with the color and type that are set in "Clear Own Track Color/Type" are deleted.

For example, when you select Red in "Clear Own Track Color" and All in "Clear Own Track Type", red lines are deleted regardless of type by "Clear Own Track" execution.

## 5.33 FILE OPERATION

Marks, lines and own tracks stored in the equipment can be output via USB terminal.

① Press the MENU button.



② Select "File Operation".

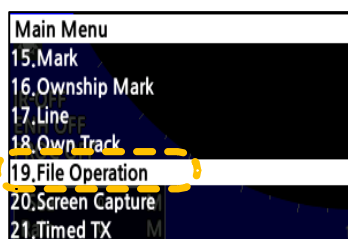

③ Select each menu.

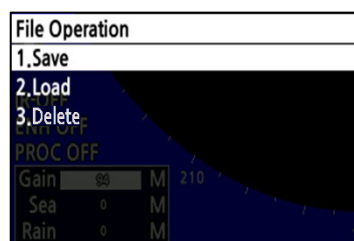

### Note:

Even if the display unit is power on with the USB memory inserted in the USB port, the USB memory is not recognized.

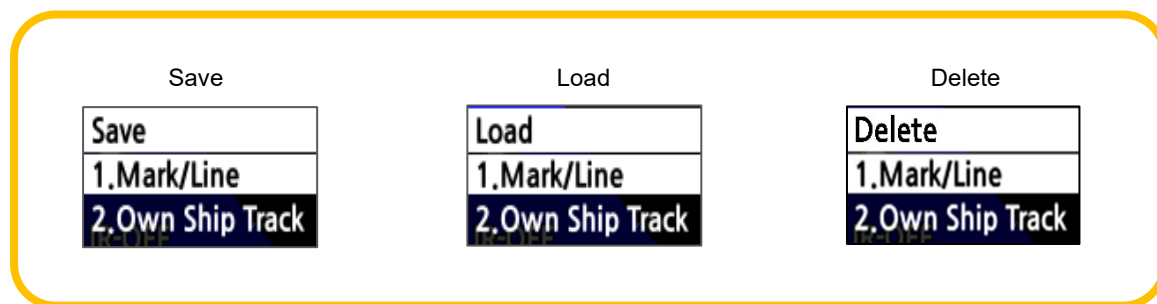

### 5.33.1 SAVE

Marks, lines and own tracks stored in the equipment can be output via USB terminal.

This operation can be worked while USB memory is inserted into the USB port on the front side.

### Note:

The rear USB port is for mouse / trackball connection only.

### 5.33.2 LOAD

Load marks, lines and own tracks from USB.

Loading the data, stored data is overwritten.

### 5.33.3 DELETE

Delete marks, lines and own tracks via USB.

## 5.34 SCREEN CAPTURE

This equipment has the screen capture function.

This function only works while the USB memory is inserted into the front USB port.

**Note:**

The rear USB port is for mouse / trackball connection only.

The captured images are saved to “JMA-3400\CAPTURE” folder in the USB memory.

① Press the MENU button.



② Select “Screen Capture”.

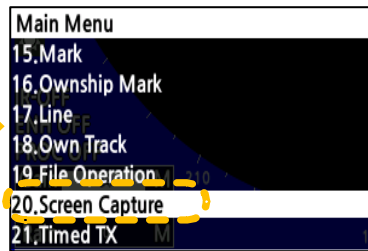

③ Select each menu.

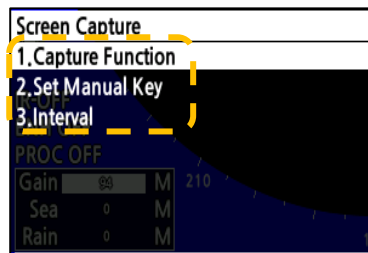

Capture function	Set Manual Key	Interval
<b>Capture Function</b> 1.OFF 2.Manual 3.Auto	<b>Set Manual Key</b> 1.USER1 2.USER2	<b>Interval</b> 10-999 10 sec ▲ Value Up ▼ Value Down ◀ Input Figure Left ▶ Input Figure Right Trails Off Track Off Vector 6 min



### 5.34.1 CAPTURE FUNCTION

Select the mode of capture function.

Off: Turn off the function.

Manual: When this mode is set, you can capture screen image by pressing User key assigned the function.

Assignment of the function can be set on "Set Manual Key."

Auto: When this mode is set, screen image is captured automatically.

The interval of screen capture can be set "Interval."

There is a capture icon at the bottom right of the screen.

Select "Manual", the capture icon turn to . Select "Auto", the icon turn to



While capturing image, a part of the capture icon color turn like this image. 

If screen capture is failed, the error message is displayed.

### 5.34.2 SET MANUAL KEY

Allocate the function to manually capture to the User key.

By initial setting, it is assigned to the USER1 key.

### 5.34.3 INTERVAL

Set the interval of screen capture automatically. Use the cross key or the MULTI control to change the value.

The interval can be set between 10 and 999 sec.

**Note:**

Radar drawing appears to stop momentarily when executing manual or automatic capture function, but this is not a malfunction. It is the moment of Digital image file is generating.

## 5.35 TIMED TX

This function reduces power consumption. When using timed TX function, the operation state is repeatedly changed between TX and standby state.

During the “Standby Time” state, non-transmission is performed and the antenna rotation stops.

① Press the MENU button.



② Select “Timed TX”.

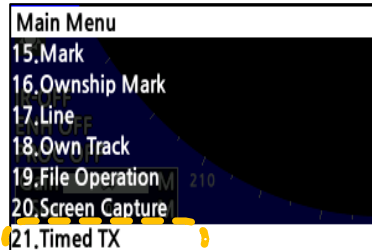

③ Select each menu.

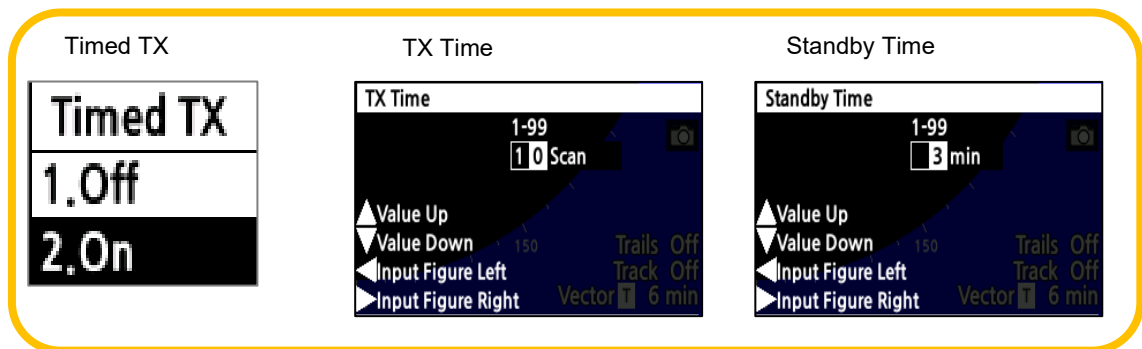
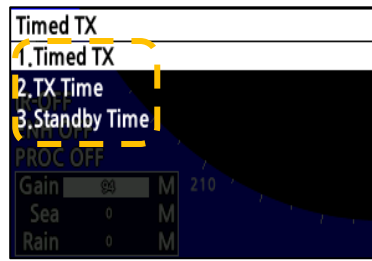

### 5.35.1 TIMED TX

Turn on/off the timed TX function.

The timed TX function can be turned off only in TX state. It cannot be turned off in standby state.

### 5.35.2 TX TIME

Set the number of antenna rotation. Use the cross key or the MULTI control to change the value.

TX time can be adjusted between 1 and 99 Scan.

### 5.35.3 STANDBY TIME

Set the time for standby state. Use the cross key or the MULTI control to change the value.

The standby time can be adjusted between 1 and 99 min.

**Note:**

If you execute function of the Timed TX, please be careful.

Because if you forget to execute the Timed TX, you will misunderstand that radar transmitting was stopped and radar echo disappeared in the transmitting. You must be remembered that you had set on function of Timed TX. Please use Timed TX with caution fully.

### 5.36 TLL TX "USER2"

This function set whether outputting TLL sentence of ownship position with pressing the User2 key.

The output port of TLL is set at "Adjust Menu/7.COM Port Setting/4.TX Port/2.TLL".

In case, you set the output port of TLL, show ON/ Off of this function at the next.

Off: Normal TLL sentence outputs from the TX Port as you set.

ON: One TLL sentence of Ownship L/L position outputs from the TX Port as you set with at the time of pressing the User2 key once.

If another function is allocated "User2 Short Press", both the assigned function and TLL TX are performed by pressing the User2 key.

### 5.37 CERTIFICATION INFORMATION

Display the certification information.

# Chapter 6 OPTION AND OTHER FUNCTIONS

## 6.1 NMEA CABLE

The JMA-3400 series has 4 channels NMEA0183 signal input and 1 channel CAN signal input allowing connecting to navigation equipment, such as GPS, for own position, waypoints and speed.

It also allows connecting a GPS compass for your heading and/or AIS for displaying targets.

In order to use the above function, CAN cable (option or commercial) is required.

- Using JRC GPS receiver, please connect NMEA4 (GPS port).
- AIS connects all NMEA port available.

<NMEA0183>

The data are received by IEC61162-1/2.

Telecommunications standard	NMEA0183 / IEC61162-1/2 is not conformity at all
Communications protocol	4800 bps, start 1bit, data 8bit, stop 1bit, With no parity
Input sentence	NMEA0183: V1.5: GGA/ GLL/ RMC V2.0: GGA/ GLL/ RMC/ ZDA V2.3: GGA/ GLL/ RMC/ GNS/ ZDA (Talker= "G P" etc.)
Information classification	about a ship -- the time entry; -- GGA/ GNS/ GLL/ RMC Day and time entry: ZDA Time entry of equipment: ZDA/ GGA/ GNS/ GLL/ RMC

IEC61162-1 / 2 (considerable) Priority of data :

Lat/Lon: GGA>RMC>RMA>GNS>GLL

SOG/COG: RMC>RMA>VTG

Log speed: VBW>VHW

Bearing signal

HEADING: THS>HDT>HDG>HDM>VHW

IEC61162-1/2(considerable)

DEPTH: DPT>DBT

4800bps/38400bps:THS>HDT>HDG>HDM>VHW

WATER TEMP: MTW

AIS: VDM,VDO,ALR

WIND: MWV>VWT,VWR

Speed signal

WAYPOINT: RMB>BWC>BWR

IEC61162 4800 bps :VBW, VHW

<CAN>

For the CAN PGN supported by the JMA-3400 series, see "13.7 INPUT/OUTPUT SIGNAL."

NMEA signal line connector wiring table

GPS

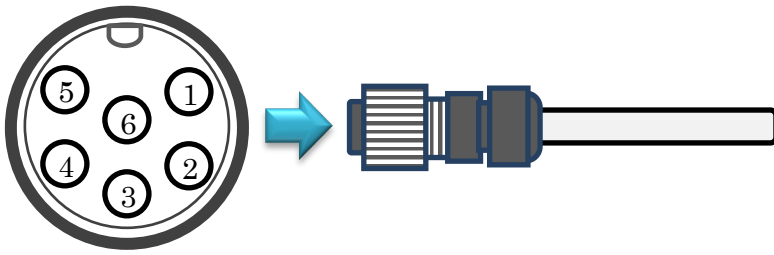

Name	Pin No.	Signal	I/O	Color
GPS	1	+12V	Out	Red
	2	GND	—	Black
	3	GPS	RXD—	White
	4		RXD+	Green
	5		TXD+	Yellow
	6		TXD—	Brown

NMEA0183

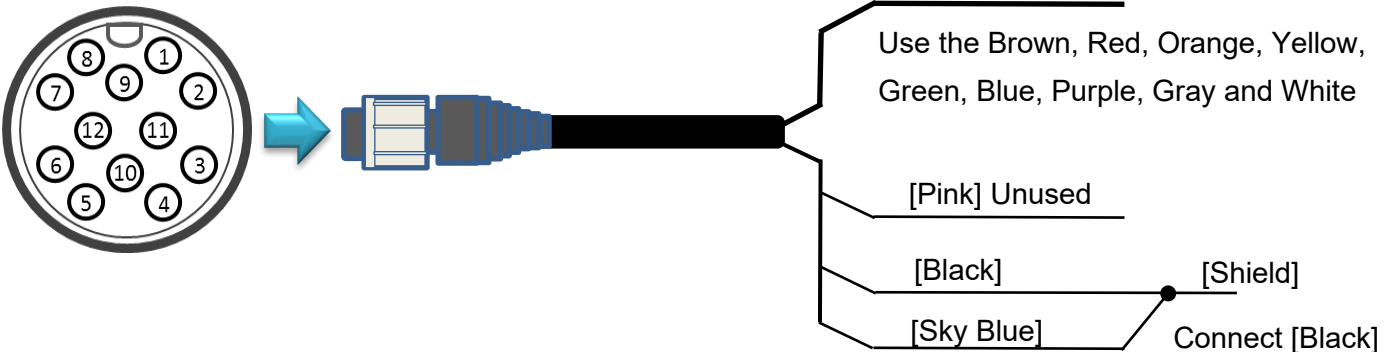

Name	Pin No.	Signal	I/O	Color
NMEA0183	1	NMEA1	RX+(A)	Brown
	2		RX—(B)	Red
	3		TX+(A)	Orange
	4		TX—(B)	Yellow
	5	NMEA2	RX+(A)	Green
	6		RX—(B)	Blue
	7		TX+(A)	Purple
	8		TX—(B)	Gray
	9	GND	—	White
	10	Shield	—	Black
	11			Pink
	12			Sky Blue

Connect [Black] and [Sky Blue] cables and use them as shield wires.

**NMEA ALARM**

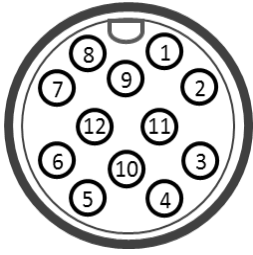

Use the Brown, Red, Orange, Yellow, Green, Blue, Purple, Gray and White cables alone.

[Pink] Unused

[Black]

[Shield]

[Sky Blue]

Connect [Black] and [SKY Blue] cables and use them as shield wires.

Name	Pin No.	Signal	I/O	Color	
NMEA_ALARM	1	NMEA3	RX+(A)	Brown	
	2		RX-(B)	Red	
	3		TX+(A)	Orange	
	4		TX-(B)	Yellow	
	5	EVENT	+	Green	
	6		-	Blue	
	7	ALARM	COM	Purple	
	8		NO	Gray	
	9	GND	-	White	
	10	Shield	-	Black	
	11				Pink
	12				Sky Blue

## 6.2 EXTERNAL MONITOR OUTPUT

### ⚠ CAUTION



If you installed the External monitor output, waterproofing (IPX5) of rear side of display unit is no guaranteed.

Through the additional interface, you can lead out the video signal to an external monitor. Additional external port is using a DVI connector. External monitor's display pixels are 800x600 dots (SVGA). It is necessary that power supply to the external monitor separately. Since the output screen is a vertical screen, use a monitor that can hold the display vertically. DVI output signal can use 5m by driver IC specification but this length also lay on the DVI cable kinds. (This is not guaranteeing the DVI cable length.)

#### External monitor mounting



Loosen the screws (2 pcs.), and remove the cover.  
Connect DVI cable.

#### Displaying one example

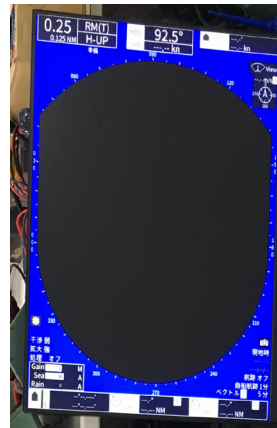

<With \*stretch>  
The screen is slightly stretched vertically.

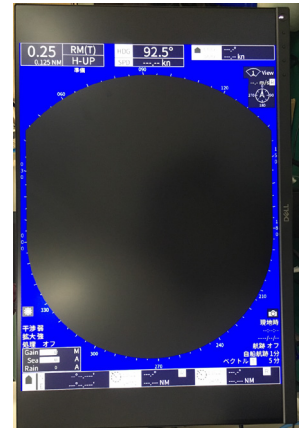

<Without \*stretch>  
Not displayed the part at the top and bottom are filled with black.

\*The stretch function is a function on the external monitor side.

## 6.3 RECTIFIER UNIT

The input voltage range is from DC +10.8V to DC +31.2V. (DC12-24V, -10%+30%).

The power consumption varies depending on the radar model name. Check the maximum power consumption described in the "12.4 GENERAL SPECIFICATIONS."

If ship's DC battery power supply is not enough to the operation of this radar, we strongly recommended that to you use following option rectifier unit.

Rectifier unit NBA-5111:	For JMA-3404, JMA-3406/HS and JMA-3412-4/4HS/6/6HS
Rectifier unit NBD-865:	For JMA-3404 and JMA-3406

# Chapter 7 INITIAL SETTINGS

The JMA-3400 series radar can observe images at the factory. However, in order to obtain optimal performance, "INITIAL SETTINGS" are required after installation. When performing the initial setting yourself, refer to this chapter and check the radar image before setting. It is recommended that you save to USB memory (see 8.5.6.1) or you keep a note of the setting by the user for return to the previous setting. Please note that improper initial settings will adversely affect performance.

① Long press MENU button.



② Input 0 and press ENT.

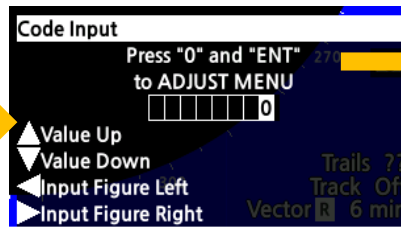

③ Select "Basic Adjustment."

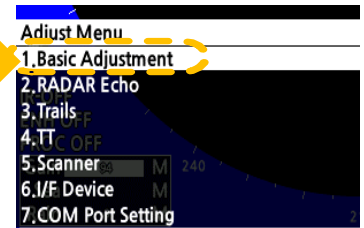

④ Select each setting item.



## Bearing Adjustment

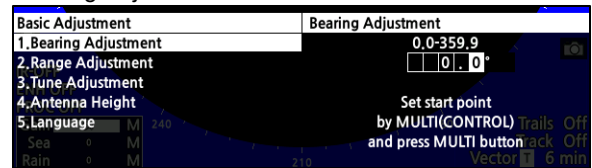

## Range Adjustment

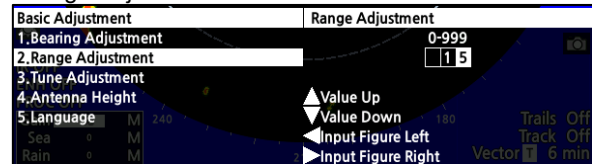

## Tune Adjustment

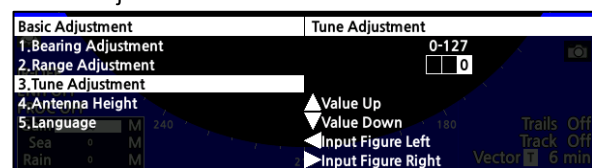

## Antenna Height

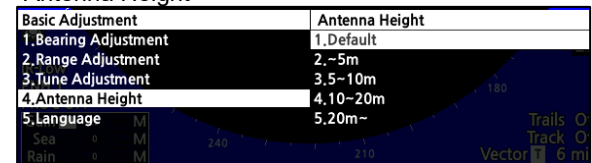

## Language

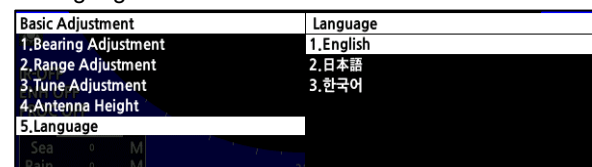



# 7.1 LANGUAGE SELECTION

① Select "Language."

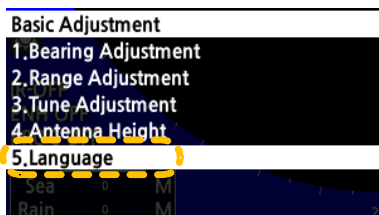

② Select preferred language.

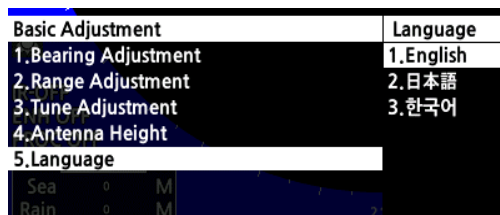

In case of choosing non-understand language, it is able to return to the English menu to input "2364" at the code input menu. At that time, please reselect the language.

# 7.2 BEARING ADJUSTMENT

Adjust the bearing so that bearing of the target measured with the ship's compass matches that of the target echo on the radar display.

Before adjustment

Measure the bearing of an adequate target (for example, a ship at anchor, a breakwater or a buoy) relative to own ship's heading.

Procedure

- (1) Radar is set to TX mode.
- (2) Adjust GAIN, RAIN and SEA to find the known target on the screen.
- (3) Adjust the bearing at the end point to display the target described in "Before adjustment" at the same direction as measured.

① Select "Bearing Adjustment."

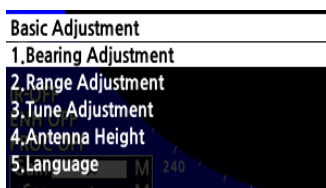

② MULTI control or cross key change the value.



③ Adjust the value so that the known target is on the set EBL.



## 7.3 RANGE ADJUSTMENT

Adjust the range so that the range of the target on the radar video is indicated correctly. This set up is make the target RANGE coincident with the VRM readout data. Read out the target range by the VRM function. The target has the same height with the radar scanner should be better. Range unit is using the NM in marine radar usually (1 NM = 1,852 m).

### Before adjustment

Select a target which range is already known.

### Procedure

- (1) Radar is set to TX mode.
- (2) Adjust GAIN, RAIN and SEA to find the known target on the screen.
- (3) Adjust the range on the radar to match to the range of the target described in “Before adjustment.”

- ① Select “Range Adjustment.”
- ② MULTI control or cross key change the value.
- ③ Adjust the value so that the known target is on the set VRM.

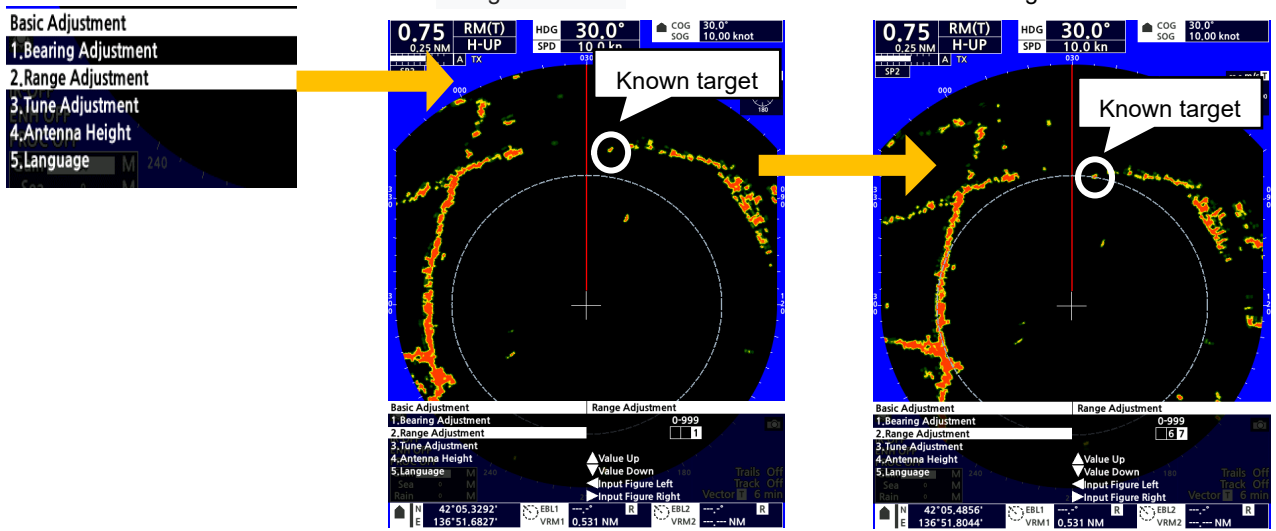

## 7.4 TUNING ADJUSTMENT

The physical dimensions of the magnetron tube in the transmitter dictate the precise transmitter output frequency of the particular set.

The tuning function control fine-tunes the receiver circuits to match their maximum sensitivity to that transmitted signal. Tuning adjustment is necessary for maintaining a high performance.

But the tuning adjustment had been already set at the factory. This adjustment value should not be changed greatly when started up the radar at first.

① Select "Tune Adjustment."



② MULTI control or cross key change the value.

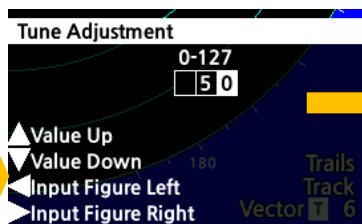

③ Adjust the tuning adjustment bar to more than 8 scales.

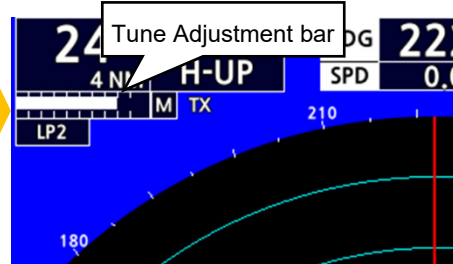

## 7.5 ANTENNA HEIGHT SET UP

Set up the antenna height.

This set up is related to sea clutter rejection control.

At a short range, sea clutter level is proportion to the height of the scanner.

Thus, an optimum sea clutter rejection constant must be selected according with the height of antenna.

① Select "Antenna Height."

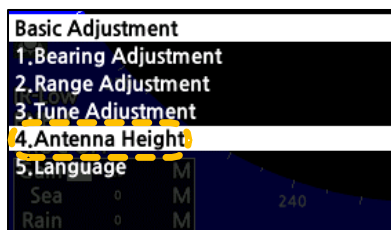

② Select an appropriate antenna height.

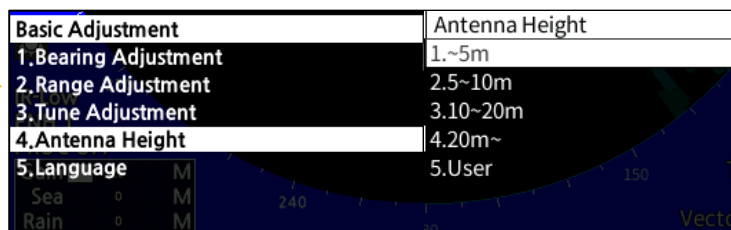

# 7.6 COMMUNICATION PORT SETUP

Set up the communication port to communicate external device.

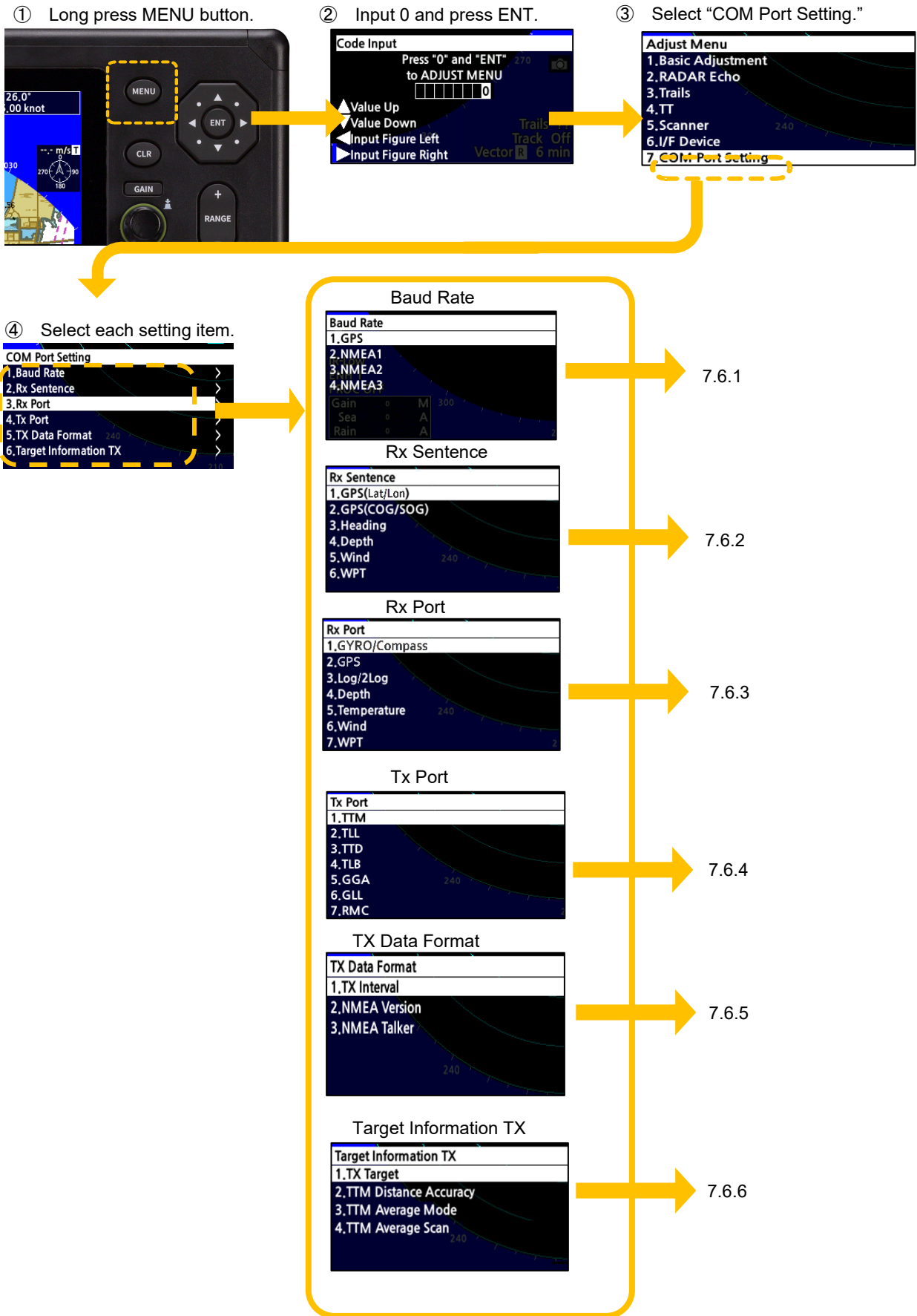

## 7.6.1 BAUD RATE

Data speed setting of communication.

Auto: Switching automatically between 4800bps and 38400bps.

① Select the GPS and NMEA port to be set.

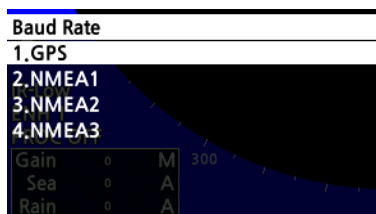

② Select Baud Rate.

The same setting is possible for other ports.

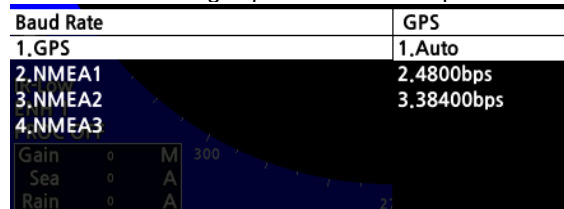

## 7.6.2 RX SENTENCE

Select whether to receive each sentence. The default value is all On.

① Select the type of sentence to be set.



② Select the sentence to be set.

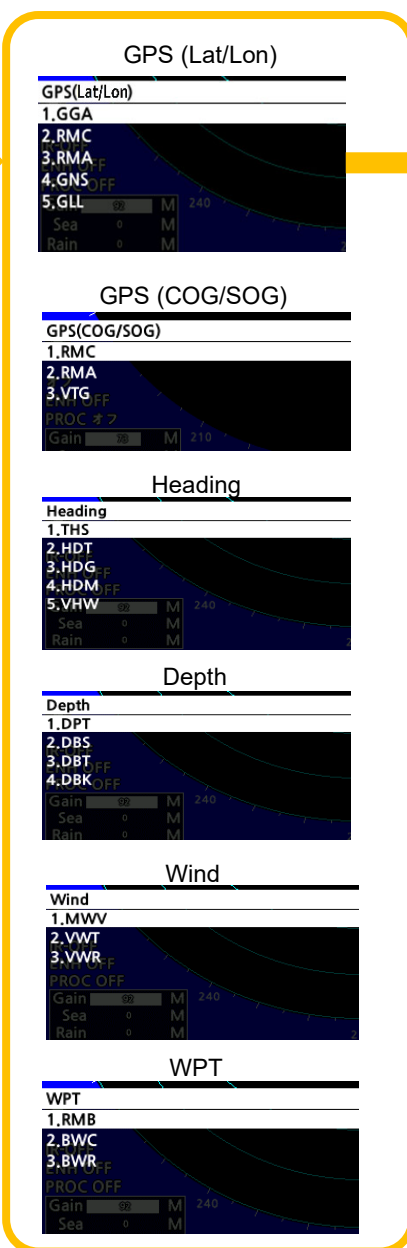

③ Set sentence reception On/Off.

The same setting is possible for other sentence.

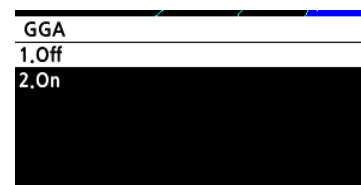

### 7.6.3 RX PORT

Choose the receive port of each signal. Set to automatic when there is no particular problem.  
 Auto: Switching automatically between CAN, GPS, NMEA1, NMEA2, and NMEA3.

(Some items, such as gyro compass, cannot select CAN.)

① Select each setting item.

Rx Port	
1.Gyro · Compass	Auto
2.GPS	Auto
3.Log · 2Log	Auto
4.Depth	Auto
5.Temperature	Auto
6.Wind	Auto
7.WPT	Auto

② Select Rx Port.

Rx Port	Gyro · Compass
1.Gyro · Compass	1.Auto
2.GPS	2.GPS
3.Log · 2Log	3.NMEA1
4.Depth	4.NMEA2
5.Temperature	5.NMEA3
6.Wind	
7.WPT	

Press cross key (down) or turn MULTI control to the right to display the next page.

Rx Port	
8.Rate of Turn	Auto
9.Rudder	Auto
Gain	M 300
Sea	M
Rain	M 270

### 7.6.4 TX PORT

Choose the transmit port of each signal.

① Select each setting item.

Tx Port	
1.TTM	
2.TLL	
3.TTD	
4.TLB	
5.GGA	
6.GLL	
7.RMC	

② Select Tx Port.

Tx Port	TTM
1.TTM	1.Off
2.TLL	2.GPS
3.TTD	3.NMEA1
4.TLB	4.NMEA2
5.GGA	5.NMEA3
6.GLL	
7.RMC	

Press cross key (down) or turn MULTI control to the right to display the next page.

Tx Port	
8.VTG	
9.OSD	
10.RSD	
11.THS	
12.HDT	M 240
Sea	M
Rain	M

## 7.6.5 TX DATA FORMAT

It sets the NMEA format of the data to be transmitted from the transmission port.

Select each setting item.

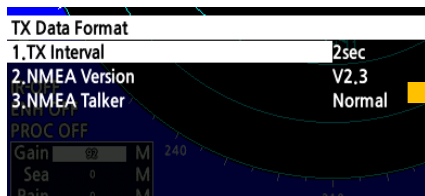

TX Interval

TX Data Format	TX Interval
1. TX Interval	1-9
2. NMEA Version	2sec
3. NMEA Talker	

NMEA Version

TX Data Format	NMEA Version
1. TX Interval	1.V2.3
2. NMEA Version	2.V2.0
3. NMEA Talker	3.V1.5

NMEA Talker

TX Data Format	NMEA Talker
1. TX Interval	1.Normal
2. NMEA Version	2.GP
3. NMEA Talker	

## 7.6.6 TARGET INFORMATION TX

Set this menu to transmit from the NMEA port the information of the ship and target that was acquired by the AIS and target tracking function (TT).

Select each setting item.

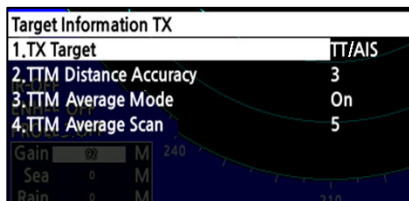

TX Target

Target Information TX	TX Target
1. TX Target	1.TT
2. TTM Distance Accuracy	2.AIS
3. TTM Average Mode	3.TT/AIS
4. TTM Average Scan	

TTM Distance Accuracy

Target Information TX	TTM Distance Accuracy
1. TX Target	1.1
2. TTM Distance Accuracy	2.2
3. TTM Average Mode	3.3
4. TTM Average Scan	

TTM Average Mode

Target Information TX	TTM Average Mode
1. TX Target	1.Off
2. TTM Distance Accuracy	2.On
3. TTM Average Mode	
4. TTM Average Scan	

TTM Average Scan

Target Information TX	TTM Average Scan
1. TX Target	2-10
2. TTM Distance Accuracy	5
3. TTM Average Mode	
4. TTM Average Scan	

## 7.7 I/F DEVICE

Make an appropriate setting for each type of equipment when inputting true bearing signals, true bearing data, and speed data.

Settings and parameters are different for each type of equipment.

Make settings for the type of equipment to be connected.





## 7.7.1 HEADING EQUIPMENT

**Note:** When you selected GPS for the heading data of heading equipment, the COG obtained from the GPS receiver is adopted as the own ship heading equipment.

Note : If you select GPS for the heading equipment, should be used temporarily only. If you want to use it, please understand below note items for safety.

Note item: If you selected GPS for the heading equipment, when the ship is stopped, the COG value will change randomly due to the position error of the GPS resulting in an undetermined bearing. Be sure to understand the following precautions before use.

- The heading direction is not fixed when the own ship is stopped, which affects the AIS and vector display.
- The heading direction which own ship moved will be the bow. Own ship heading course is not correct when the ship is drifting.
- There is in case that COG or SOG set "Null" depending on GPS equipment. If COG or SOG is set to "Null", the own ship heading numerical cannot display, AIS displaying and vector displaying.

Selects the input of the heading data of own ship. The heading data of own ship can be selected from the heading information of manual input, GYRO/Compass and GPS.

For automatic input, select an equipment which can receive the following sentences.

THS>HDT>HDG>HDM>VHW

For manual input, the heading information manually set in "7.7.2 MANUAL HEADING" can be used.

GYRO/Compass: Input the heading data of own ship from GYRO interface, GPS compass or electronic compass

GPS: Input the heading data of own ship from GPS receiver.

## 7.7.2 MANUAL HEADING

When 7.7.1(HEADING EQUIPMENT) is selected manual, please input heading direction value. Some functions that require heading information by the manual setting value set will be operational, but please do never forget that it is running in head up always.

## 7.7.3 SPEED EQUIPMENT

Selects the input of the speed data of own ship.

GPS: Input the speed data of own ship from GPS receiver.

Log/2axis Log: Input the speed through water data of own ship from Log (1-axis log) or 2Log (2-axis log).

For manual input, the speed information manually set in “7.7.4 MANUAL SPEED” can be used.

## 7.7.4 MANUAL SPEED

When 7.7.3 (SPEED EQUIPMENT) is selected manual, please input speed value. Manual setting value is used in the processing of internal. The value that affects the relative length of radar trail and vector. Please do not use it in the actual operation.

## 7.7.5 MAGNETIC COMPASS

Select each setting item.

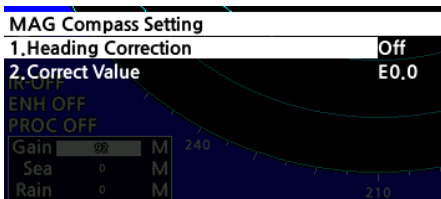

When this setting is ON, the magnetic compass value can be corrected.  
Set to OFF when no correction is performed.

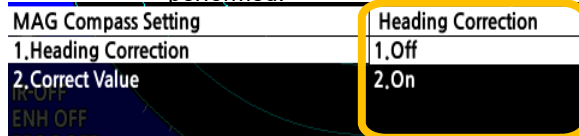

**Note:**

This setting is compensated for HDM sentence.

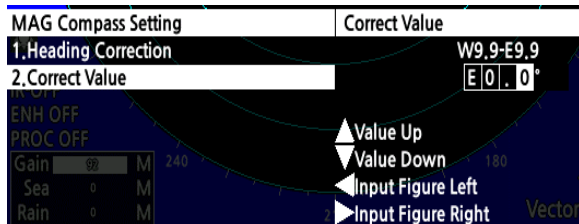

## 7.8 JRC GPS

This setting is available only JRC GPS receivers directly connected to the connector for which “GPS” is engraved at the rear of the cabinet.

① Long press MENU button.



② Input 0 and press ENT.

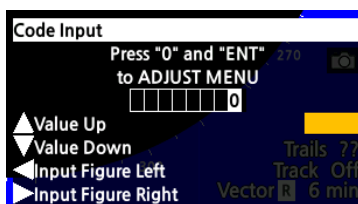

③ Select “GPS.”

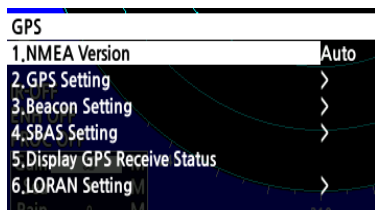
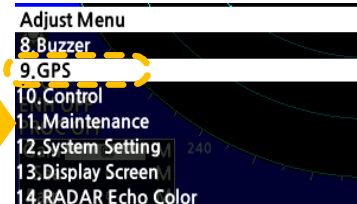

④ Select each setting item.

To 7.8.6

### NMEA Version

GPS	NMEA Version
1.NMEA Version	1.Auto
2.GPS Setting	2.V1.5
3.Beacon Setting	3.V2.1
4.SBAS Setting	4.V2.3
5.Display GPS Receive Status	
6.LORAN Setting	

### LORAN Setting

1.Display Time Zone	Off
2.LORAN A	>
3.LORAN C	>

### GPS Setting

1.Correction Method	GPS Single
2.Fix Mode	AUTO
3.Elevate Mask	5°
4.HDOP	20
5.Smooth Lat/Lon	10sec
6.Smooth SOG	10sec
7.Smooth COG	10sec

### Beacon Setting

1.Select	AUTO
2.Frequency	321.0kHz
3.Baud Rate	200bps
4.Send Data	

### SBAS Setting

1.Satellite Search	AUTO
2.Type0 Information	Off
3.Ranging	Off
4.SBAS Satellite Number	120
5.Send Data	

### Display GPS reception status

### 7.8.1 NMEA VERSION

Set the NMEA version of output GPS sentence. When the “Auto” mode is selected, NMEA version of the connected equipment is automatically detected.

## 7.8.2 GPS SETTING

GPS Setting	
1. Correction Method	GPS Single
2. Fix Mode	AUTO
3. Elevate Mask	5°
4. HDOP	20
5. Smooth Lat/Lon	10sec
6. Smooth SOG	10sec
7. Smooth COG	10sec

Press cross key (down) or turn MULTI control to the right to display the next page.

GPS Setting	
8. Smoothing1	10sec
9. Smoothing2	10sec
10. RAIM Accuracy Level	100m
11. Exclusion Satellite	>
12. Send Data	>
13. GPS Adjust	>

Select each setting item.

**Correction Method**

Correction Method

1. GPS Single
2. SBAS
3. Beacon
4. AUTO

**Fix Mode**

Fix Mode

1. 2D
2. 3D
3. AUTO

**Elevate Mask**

Elevate Mask

5-89

5°

▲ Value Up  
▼ Value Down  
◀ Input Figure Left  
▶ Input Figure Right

**HDOP**

HDOP

1. 4
2. 10
3. 20

**Smooth Lat/Lon**

Smooth Lat/Lon

0-99

10 sec

▲ Value Up  
▼ Value Down  
◀ Input Figure Left  
▶ Input Figure Right

**Smooth SOG**

Smooth SOG

0-99

10 sec

▲ Value Up  
▼ Value Down  
◀ Input Figure Left  
▶ Input Figure Right

**Smooth COG**

Smooth COG

0-99

10 sec

▲ Value Up  
▼ Value Down  
◀ Input Figure Left  
▶ Input Figure Right

**Smoothing1**

Smoothing1

0-99

10 sec

▲ Value Up  
▼ Value Down  
◀ Input Figure Left  
▶ Input Figure Right

**Smoothing2**

Smoothing2

1. 0sec
2. 10sec
3. 40sec

**RAIM Accuracy Level**

RAIM Accuracy Level

1. Off
2. 10m
3. 30m
4. 50m
5. 100m

**Exclusion Satellite**

Exclusion Satellite

1. Exclusion Satellite1	0
2. Exclusion Satellite2	0
3. Exclusion Satellite3	0
4. Exclusion Satellite4	0
5. Exclusion Satellite5	0
6. Exclusion Satellite6	0

**GPS Send Data**

Send Data

Are you sure?

YES No

**GPS Adjust**

GPS Adjust

1. Position
2. Antenna Height 10m
3. Time 00:00:00
4. Date 2010-01-01
5. Master Reset
6. Send Data

7.8.2.11

7.8.2.13

148

### 7.8.2.1 CORRECTION METHOD

Set the correction method. When SBAS is selected, the GPS receiver must be compatible with SBAS.

- GPS Single: Fix a position only with single GPS. Does not perform fixing with SBAS or beacon.
- SBAS: Fix a position with SBAS or single GPS. Does not perform fixing with beacon.
- Beacon: Fix a position with beacon or single GPS. Does not perform fixing with SBAS.
- AUTO: The optimum setting is selected from single GPS, SBAS and beacon.

### 7.8.2.2 FIX MODE

Set the GPS fix mode.

- 2D: 2D positioning can be done with height acquired.
- 3D: 3D positioning can be done with height acquired.
- AUTO: 2D positioning and 3D positioning can automatically be selected with optimum.

### 7.8.2.3 ELEVATE MASK

Limit the satellite to be used with elevation angle.

### 7.8.2.4 HDOP

Set the HDOP level of the GPS receiver.

The smaller the value, the higher the accuracy although fixing a position becomes difficult.

### 7.8.2.5 SMOOTHING LAT/LON

Smoothing can be applied to measured positions. The higher the smoothing value, the smoother the results will be, but the greater the time lag. Conversely, if the smoothing value is set low, a great number of changes will occur, but there will be little time lag. As such, it is important to choose the optimal value for own usage situation.

### 7.8.2.6 SMOOTHING SOG

Smoothing can be applied to measured speeds. The higher the smoothing value, the smoother the results will be, but the greater the time lag. Conversely, if the smoothing value is set low, a great number of changes will occur, but there will be little time lag. As such, it is important to choose the optimal value for own usage situation.

### 7.8.2.7 SMOOTHING COG

Smoothing can be applied to measured courses. The higher the smoothing value, the smoother the results will be, but the greater the time lag. Conversely, if the smoothing value is set low, a great number of changes will occur, but there will be little time lag. As such, it is important to choose the optimal value for own usage situation.

### 7.8.2.8 SMOOTHING1

This setting is corresponding to relatively new JRC GPS model.

**Note:** The smoothing setting range is depending on the JRC GPS software version.

- 0 to 99 sec (R29.04~R33.99)
- 1 to 99 sec (R26.01~R29.03)

Smoothing function can be applied to measured positions, speeds and courses.

However, if the set value of the smoothing is too high, it is possible to obtain a smooth result, but a large time lag is generated at the same time.

Conversely, if the set value of the smoothing is too low, many changes will be generated, but the time lag will be reduced considerably. Thus, it is important to choose an optimal value for own usage function.

### 7.8.2.9 SMOOTHING2

This setting is corresponding to relatively old JRC GPS model.

**Note:** The smoothing setting range is as below.

0/10/40 sec

Smoothing function can be applied to measured positions, speeds and courses. However, if the set value of the smoothing is too high, it is possible to obtain a smooth result, but a large time lag is generated at the same time.

Conversely, if the set value of the smoothing is too low, many changes will be generated, but the time lag will be reduced considerably. Thus, it is important to choose an optimal value for own usage situation.

### 7.8.2.10 RAIM ACCURACY LEVEL

Set the RAIM accuracy level to be used. RAIM is the function that the receiver judges whether the accuracy of GPS position information meets the conditions or not. The higher the accuracy level is, the wider the judgment range is. When off is selected, RAIM accuracy level function is stopped and the judgment cannot be performed. For single GPS, set to 30m or more.

### 7.8.2.11 EXCLUSION SATELLITE

It uses the GPS satellites to get position information. But in this setting it sets for a satellite to disable. Please set when the failed GPS satellite was found.

① Select each setting item.

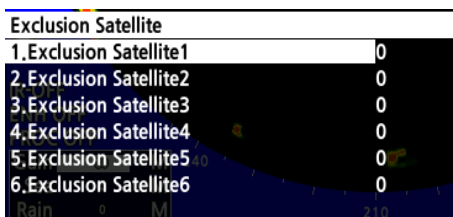

② Change the value.

Exclusion Satellite 1~6 can be set in the same way

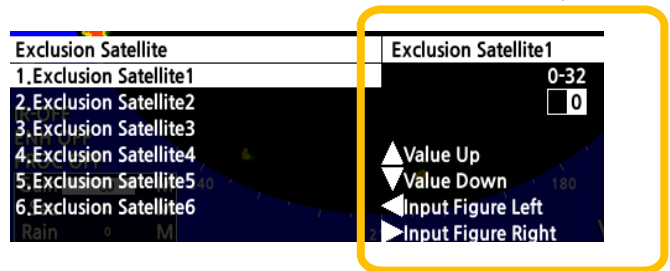

① Use the cross key or MULTI control to set a value between 0 and 32.

### 7.8.2.12 GPS SETTING SEND DATA

Send GPS setting Data to the GPS receiver.



### 7.8.2.13 GPS ADJUST

Select each setting item.

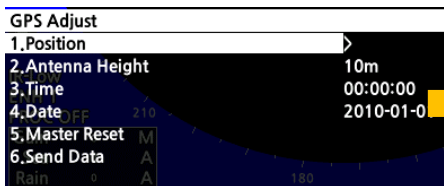

#### Position

Enter latitude and longitude.



#### Antenna Height

Set the height of the antenna.

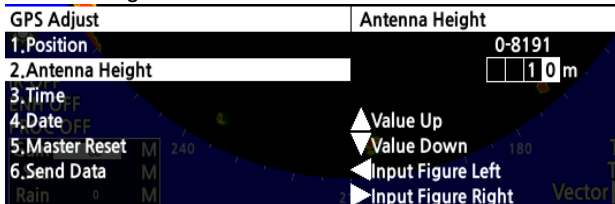

#### Time

Enter the current time in UTC.

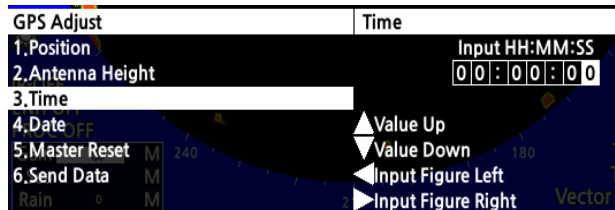

#### Date

Enter the Date in UTC.

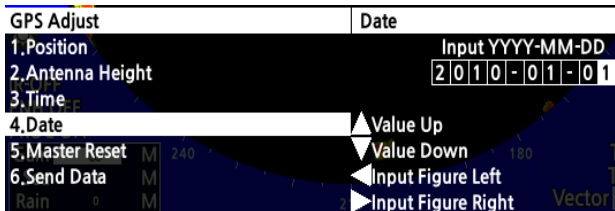

#### GPS Adjust Master Reset

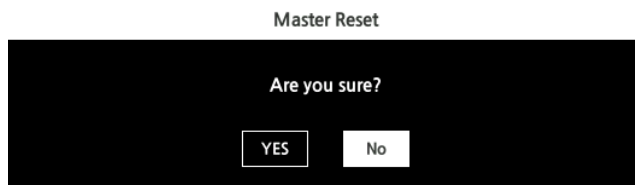

#### GPS Adjust Send Data



### 7.8.3 BEACON SETTING

Set for a JRC Beacon (DGPS receiver). This setting is available only for JRC Beacon receiver (DGPS receiver).

AUTO: Select an optimum beacon station automatically.

Manual: The beacon frequency and baud rate need to be set manually.

**Note:** This setting is enabled when “Station Select” is set to “Manual.”

Select each setting item.

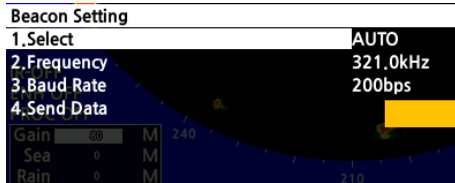

Select

Automatic/manual selection of stations.

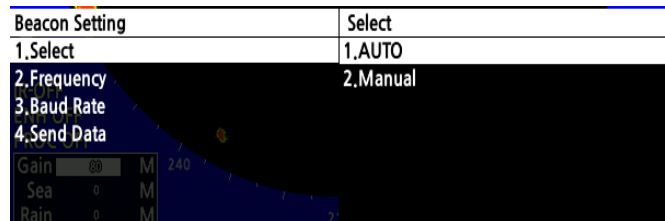

Frequency

Set “beacon frequency.”

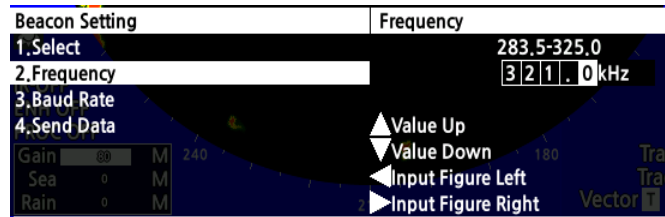

Baud Rate

Selection of beacon bit rate.

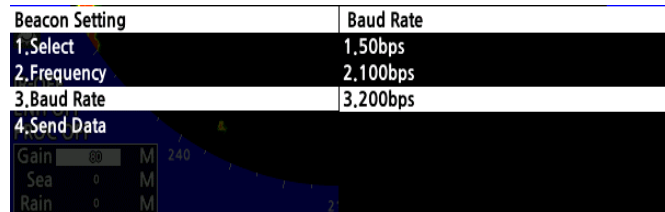

Send Data





## 7.8.4 SBAS SETTING

AUTO: Automatically selects the SBAS satellite number.

Manual: Manually enter the SBAS satellite number.

**Note:** This setting is enabled when "Station Select" is set to "Manual."

Select each setting item.

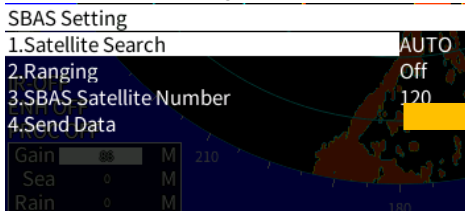

Satellite Search

Select satellite search mode.

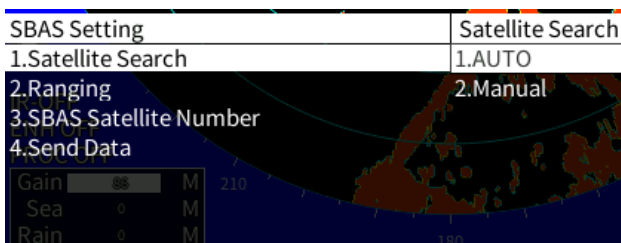

Ranging

Select ranging.

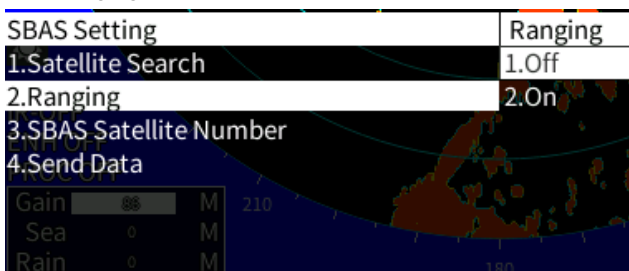

SBAS Satellite Number

Select SBAS satellite number.

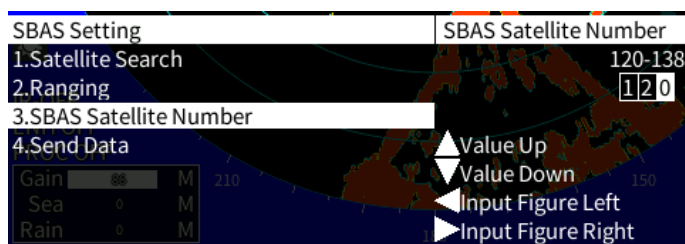

Send Data

Sends the SBAS set value.



## 7.8.5 GPS STATUS DISPLAY

Display the reception status of the GPS receivers ( GPS, DGPS and WAAS receivers) currently connected. This setting is available only for JRC GPS/DGPS/WAAS receiver directly connected to the connector for which “GPS” is engraved at the cabinet. This function cannot indicate with transmission state.

## 7.8.6 LORAN SETTING

Set up LORAN.

Select each setting item.

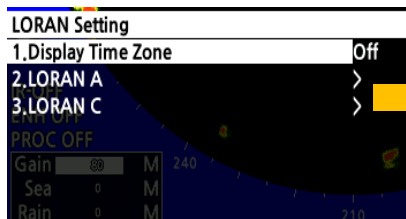

Display Time Zone

Set the time difference display.

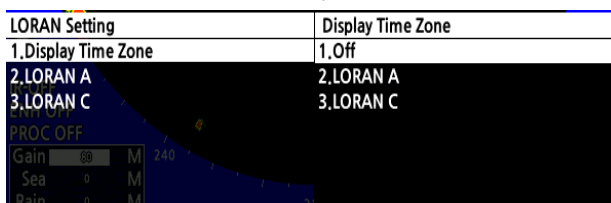

LORAN A

Set LORAN A.

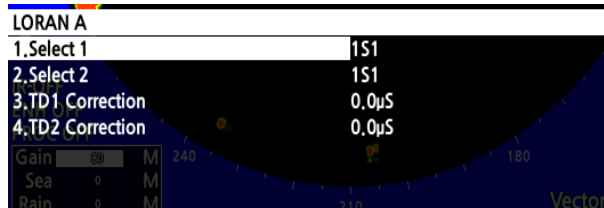

LORAN C

Set LORAN C.

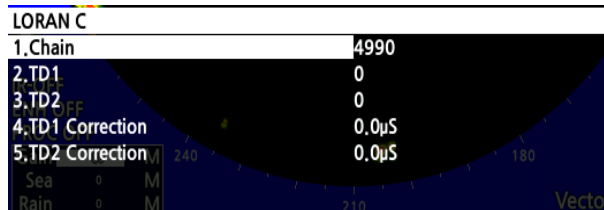

# Chapter 8 DETAIL PERFORMANCE SETTINGS

## 8.1 RADAR ECHO

This setting are items that greatly affects the radar image. When you want to change, please change while observing the radar image carefully.

- ① Long press the MENU button.
- ② Input "0" and press ENT button.
- ③ Select "RADAR Echo."

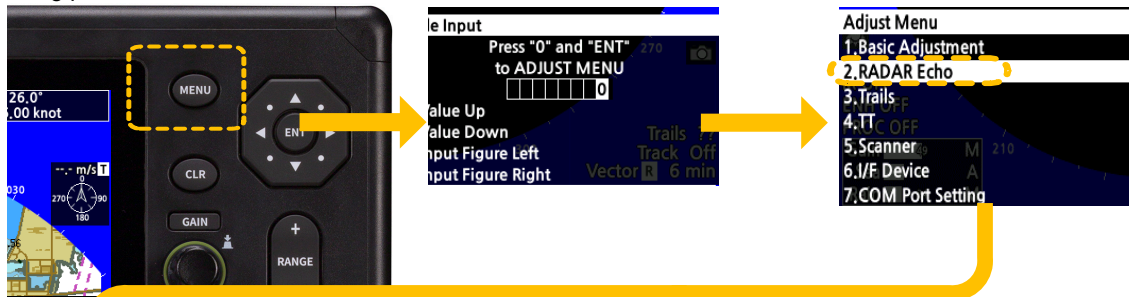

- ④ Select each setting item.

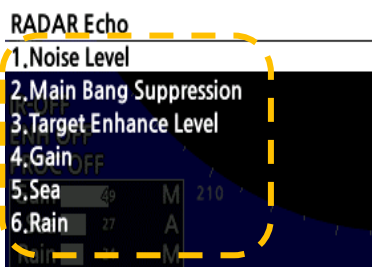

**Noise Level**

Noise Level 0-255  
1 3 3

▲ Value Up  
▼ Value Down 150  
▶ Input Figure Left  
◀ Input Figure Right Vector 30 mi

---

**Main Bang Suppression**

Main Bang Suppression

1. Main Bang Suppression Area  
2. Main Bang Suppression Slope  
3. Main Bang Suppression Level

PROC OFF

---

**Target Enhance Level**

Target Enhance Level

1. Level1  
2. Level2  
3. Level3  
4. Level4

---

**Gain**

Gain

1. Preset

IR-OFF

---

**Sea**

Sea

1. STC Curve Select  
2. STC Slope Correction  
3. STC Offset

PROC OFF

---

**Rain**

Rain

1. FTC Curve Select  
2. FTC Slope Correction  
3. FTC Offset

PROC OFF

\* Press the cross key or turn the MULTI control to set the value.

8.1.2

8.1.3

8.1.4

8.1.5

8.1.6

## 8.1.1 NOISE LEVEL

Adjust the noise level.

The noise level is adjusted at the factory. When adjusting the noise level after installation, perform only fine-tuning within  $\pm 5$ .

## 8.1.2 MAIN BANG SUPPRESSION

Main Bang Suppression is adjusted to suppress main bang, a reflection signal from 3D circuit including wave guide tube, that generally appears as a circular image focusing on the center of the radar display. Optimum adjustment allows main bang image to remain lightly on the display.

If the main bang is not so big, use the default setting at factory.

Before adjustment:

1. Set the range to 0.125NM.
2. Set the radar video enhance function.
3. Set the radar video process function.
4. Turn the [GAIN] control to the maximum position.
5. Turn the [RAIN] control to the minimum position.
6. Turn the [SEA] control to achieve the strength with which main bang can be judged.



# WARNING



**Do not change suppression level/area unless absolutely necessary. Incorrect adjustment will result in deletion of nearby target images and thus collisions may occur resulting in accidents.**

Select each setting item.

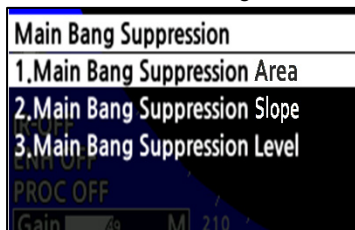

Main Bang Suppression Area

Main Bang Suppression Slope

Main Bang Suppression Level

※Enter values with the cross key or MULTI control.

### 8.1.3 TARGET ENHANCE LEVEL

Sets the level of target enhancement.

Target enhance level can be set from level1 to level4.If the level is set too high, the range resolution may be declined. Thus, it is necessary to set a value properly.

### 8.1.4 GAIN

Adjust the minimum sensitivity level of the [GAIN] control.

Do not change this adjusted level carelessly.

The value is usually set to 0 and should not be changed unless there is problem.

Before performing this adjustment, perform the operation described in "NOISE LEVEL."

## CAUTION



If sensitivity is set too high, unnecessary signals such as noises in the receiver and false echoes increase to lower target visibility. At the same time, if sensitivity is set too low, detection of targets such as ships and dangerous objects may be hindered. Therefore, sensitivity must always be set to an optimal level.

### 8.1.5 SEA

Set the STC Curve. User selects the "river" or "sea" of the curve selection. Please do not change the STC offset and slope correction. If the value changed, affects sea clutter suppression function drastically.

## CAUTION



When using the sea clutter suppression function, never set the suppression level too high canceling out all image noises from the sea surface at close range. Detection of not only echoes from waves but also targets such as other ships or dangerous objects will become inhibited. When using the sea clutter suppression function, make sure to choose the most appropriate image noise suppression level.

Select each setting item.

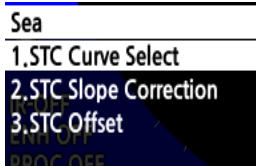

STC Curve Select

STC Curve Select

1.Sea

2.River

STC Slope Correction

STC Slope Correction

0.0-2.0

1.0

▲ Value Up

▼ Value Down

◀ Input Figure Left

▶ Input Figure Right

STC Offset

STC Offset

0-FF

0

▲ Value Up

▼ Value Down

◀ Input Figure Left

▶ Input Figure Right

\* Press the cross key or turn the MULTI control to set the value.

## 8.1.6 RAIN

Set the FTC Curve. User selects the "river" or "sea" of the curve selection. Please do not change the FTC offset and slope correction. If the value changed, affects rain clutter suppression function drastically.



**CAUTION**

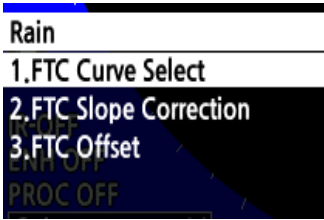

**When using the rain clutter suppression function, never set the suppression level too high canceling out all image noises from the sea surface at close range. Detection of not only echoes from waves but also targets such as other ships or dangerous objects will become inhibited. When using the sea clutter suppression function, make sure to choose the most appropriate image noise suppression level.**

Select each setting item.





FTC Curve Select

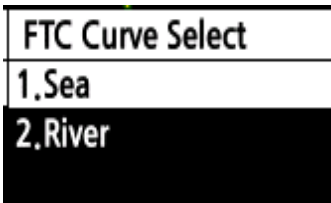

FTC Slope Correction

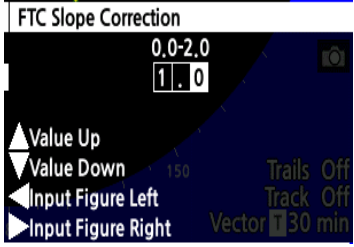

FTC Offset

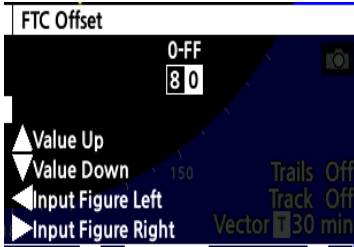

\* Press the cross key or turn the MULTI control to set the value.

## 8.2 TRAILS

Set the radar trails setting.

① Long press the MENU button. ② Input "0" and press ENT button. ③ Select "Trails".

④ Select each setting item.

**Trails**

- Trails Suppression Distance
- Max Interval
- Range Limit

**Trails Suppression Distance**

Trails Suppression Distance  
0-1000  
0 m

Value Up  
Value Down  
Input Figure Left  
Input Figure Right

**Max Interval**

Max Interval

- Short
- Middle
- Long
- Super Long

**Range Limit**

Range Limit

- No Limit
- Under 2 Range
- Under 3 Range
- Under 4 Range

\* Press the cross key or turn the MULTI control to set the value.

### 8.2.1 TRAILS SUPPRESSION DISTANCE

Set the suppression distance of trails.

Trail of target that is closer from own ship than the value of this function setting is not created.

## 8.2.2 MAX INTERVAL

Set the group of trails. Selected group is displayed in the main menu.

Use Short if you use short radar tracks a lot, such as in the bay.

Use Super Long if you need a long radar track, such as in open sea voyages.

Middle is an intermediate specification between Short and Long. In addition, continuous track can be used for all set values.

Short: OFF/15sec/30sec/1min/2min/3min/4min/5min/6min/10min/15min/Continuous

Middle: OFF/30sec/1min/2min/3min/4min/5min/6min/10min/15min/30min/Continuous

Long: OFF/1min/2min/3min/4min/5min/6min/10min/15min/30min/1hour/Continuous

Super Long: OFF/30min/1hour/2hour/3hour/4hour/5hour/6hour/10hour/12hour/24hour/Continuous

## 8.2.3 RANGE LIMIT

Set the range to take over trails.



## 8.3 TARGET TRACKING (TT)

# ⚠ CAUTION



Do not change the settings of this function unless absolutely necessary. If set at an inappropriate value, the acquisition or tracking function of the target tracking function (TT) deteriorates, and this may lead to accidents.

① Long press the MENU button.



③ Input "0" and press ENT button.

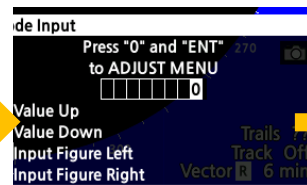

② Select "TT".

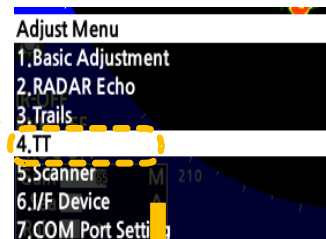

④ Select each setting item.

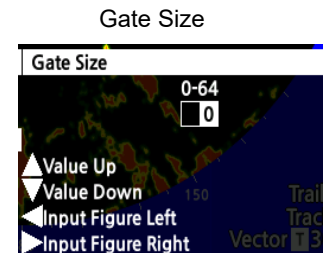
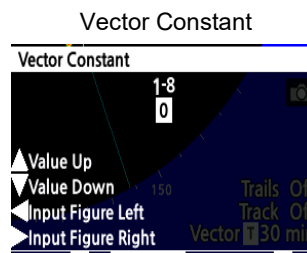
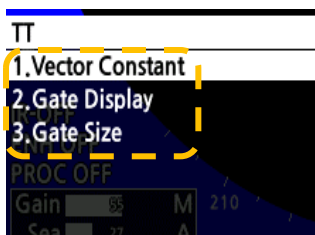

Gate Display

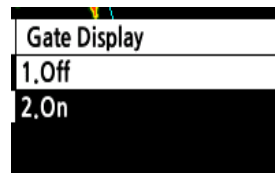

\* Press the cross key or turn the MULTI control to set the value in "Vector Constant" and "Gate Size".

**Vector Constant:** Vector shows the movement of the target. When Vector Constant is large, vector is stable, but the response is slow. When Vector Constant is small, vector is unstable, but the response is quick.

**Gate Size:** Set up the region size which can search the movement target automatically. When region is wide, possible to track fast moving target, but many clutters are included. Sometime do miss tracking because of much noise. When region is narrow, possible to track stable, but fast moving targets are tend to lost. Because of fast target soon goes outside of the region.

**Gate Display:** Set the display on/off of target detection area (gate) for target trail function.

### Note:

The TT function requires own ship's heading and GPS signal (COG/SOG) information. If there are not these information, TT function does not function correctly.

# 8.4 SCANNER

- ① Long press the MENU button.
- ② Input "0" and press ENT button.
- ③ Select "Scanner."

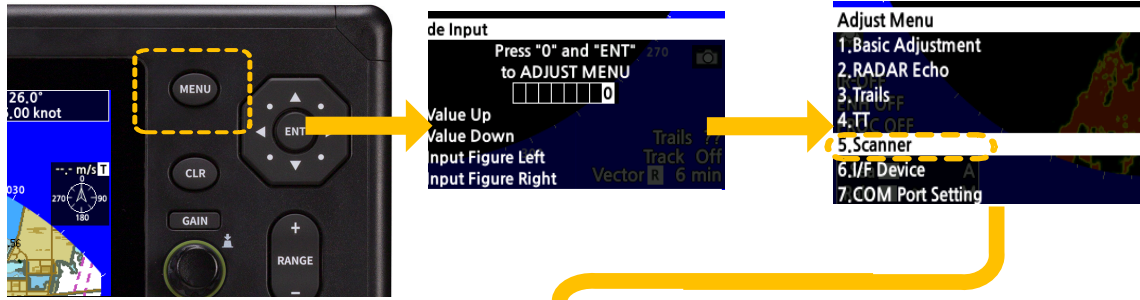

- ④ Select each setting item.

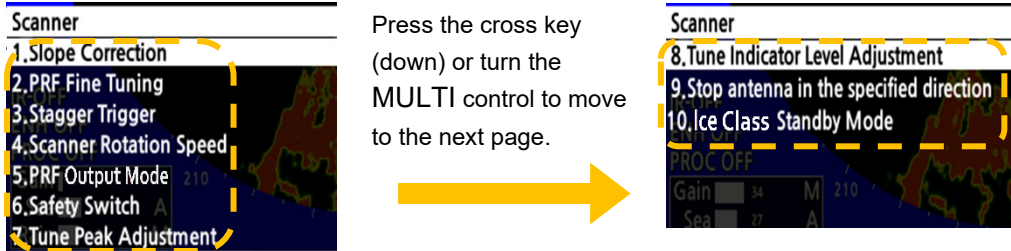

**Slope Correction**

**Pulse Repetition Frequency Fine Tuning (PRF Fine Tuning)**

**Stagger Trigger**

**Scanner Rotation Speed**

**PRF Output Mode**

**Safety Switch**

**Tune Peak Adjustment**

**Tune indicator Level Adjustment**

**Stop antenna in the specified direction**

**Ice Class Standby Mode**

\* Press the cross key or turn the MULTI control to set the value.

To 8.4.4

To 8.4.9

## 8.4.1 SLOPE CORRECTION

The dynamic range of scanner receiver is different.

Therefore, adjust the characteristics with this function.

## 8.4.2 PULSE REPETITION FREQUENCY FINE TUNING (PRF FINE TUNING)

If radar's interference patterns are concentrically displayed, increment or decrement the set value by 3 to 4 in order to heighten the effect of interference rejection.

PRF Fine Tuning:

Fine-tune the transmitting repetition frequency of the transmitter in the range 90% to 100%.

This setting cannot be performed simultaneously with the setting of "STAGGER TRIGGER."

## 8.4.3 STAGGER TRIGGER

Turn on/off the interference reduction function controlled by the transmission repetition frequency control of the transmitter.

This function is effective when radar interference does not go away.

This setting cannot be performed simultaneously with the setting of "PRF FINE TUNING."

## 8.4.4 SCANNER ROTATION SPEED

Set the scanner rotation speed for each pulse width. The radar sensitivity is higher when antenna is rotating in low speed.

Short range operation requires a high speed antenna rotation to refresh the screen as soon as possible.

Long range operation requires a low speed antenna rotation to maintain a high sensitivity.

You can select a rotational speed according to your request.

### Note:

The following setting values of the rotation speed are the setting values for the motor, and the actual rotation speed of the antenna will cause a slight error toward the setting value.

In addition, this value is a guide when there is no wind, and errors may occur depending on the wind direction and wind speed.

- JMA-3406, JMA-3411-4, JMA-3411-6  
0=27.0rpm, 1=25.4rpm, 2=23.8rpm, 3=22.2rpm, 4=20.6rpm, 5=19.0rpm, 6=17.4rpm, 7=16.0rpm
- JMA-3404, JMA-3406HS, JMA-3411-4HS, JMA-3411-6HS  
0=48rpm, 1=42rpm, 2=36rpm, 3=30rpm, 4=27rpm, 5=24rpm, 6=20rpm, 7=16rpm

## 8.4.5 PRF OUTPUT MODE

Select the operation mode of the transmitting repetition frequency of the transmitter.

Normal: Default setting is Normal. Both appropriate sensitivity and magnetron life expectancy are considered.

Economy: Sensitivity lowers, but the service life of magnetron is prolonged when short pulses are used.

High Power: Sensitivity improves when long pulse is used, but the service life of magnetron is slightly shortened.

## 8.4.6 SAFETY SWITCH

Set the status of safety switch.

You can select the status from the following items.

TX-Off/Standby/TX-On/Ignore Error

### 8.4.7 TUNE PEAK ADJUSTMENT

## CAUTION



**Don't adjust the tune peak adjustment value unless the serviceman. This value is already setting in the factory. If change this value in unnecessary, Auto Tune function will be influenced, and radar echo will become weak at Auto Tune, and this may lead to accidents.**

Please make adjustments tuning indicator bar to be swing largest at the tuning position of the maximum sensitivity. This adjustment must be done with (8.4.8 Tuning indicator) alternately.

Set the range to 48NM.

**Note:**

Always to be set the tune-peak-adjustment value of near the 64 at the factory.

When the equipment is used for a long time and automatic tuning function no longer works properly, adjusting the tune peak adjustment value may result in improvement of the automatic tuning function.

It should be noted that an optimal adjustment value is required for proper operation of the automatic tuning function.

### 8.4.8 TUNE INDICATOR LEVEL

## CAUTION



**Don't adjust the tune indicator level value to 100% tune bar. This value is already setting in the factory. If change this value in unnecessary, Auto Tune function will be influenced, and radar echo will become weak at Auto Tune, and this may lead to accidents.**

If the tuning level is too low, then you need to adjust the tune indicator level.

Set the range to 48NM.

**Note:**

Do not let the tune indicator bar reach 100% while adjusting the tune level.

The automatic tuning function may not perform properly if the bar reaches 100%.

Set the level such that the tune indicator bar always reads 80% to 90%.

### 8.4.9 STOP ANTENNA IN THE SPECIFIED DIRECTION

Stop antenna in the specified direction when switching from TX mode to STBY mode.

Select "ON/OFF", and turn the function on/off.

Select "Angle", and specify the direction of stopping antenna.

It will be the relative direction from your ship, so please measure and adjust the direction with EBL.

### 8.4.10 ICE CLASS STANDBY MODE

In this mode, the scanner is rotated when transmission is in the standby state.

This mode is effective to prevent the antenna's rotating shaft from freezing.

## 8.5 CONTROL

You can adjust the function button and control.

① Long press the MENU button.

② Input "0" and press ENT button.

③ Select "Control."

④ Select each setting item.

\* Press the cross key or turn the MULTI control to set the value.

\* Sea Control/Rain Control menu are the same as Gain control.

### 8.5.1 MULTI CONTROL MENU TIME OUT

If no operation is made after the MULTI control menu is displayed, the menu display can be turned off after the specified time has elapsed.

If 0 second is set, the menu display will not be turned off in no operation.

### 8.5.2 CROSS KEY GAIN

Set the cursor acceleration when the cross key is pressed and held.

The larger the value is, the faster the acceleration is, or vice versa.

### 8.5.3 MULTI CONTROL

Set the cursor movement amount when MULTI control is operated.

The larger the value is, the greater the amount of movement is, or vice versa.

EBL: Set the amount of movement when turning the dial to set EBL.

VRM: Set the amount of movement when turning the dial to set VRM.

Common: Set the amount of movement when turning the dial for Parallel cursor.

### 8.5.4 GAIN CONTROL/SEA CONTROL/RAIN CONTROL

Set the settings of GAIN/SEA/RAIN control.

Select "Response Level", and set the response level. If you set a large value, the amount of movement will also increase.

Select "Min Preset", and set the gain when turning the control to minimum position.

Select "Max Preset", and set the gain when turning the control to maximum position.

## 8.6 BUZZER

You can adjust the buzzer volume.

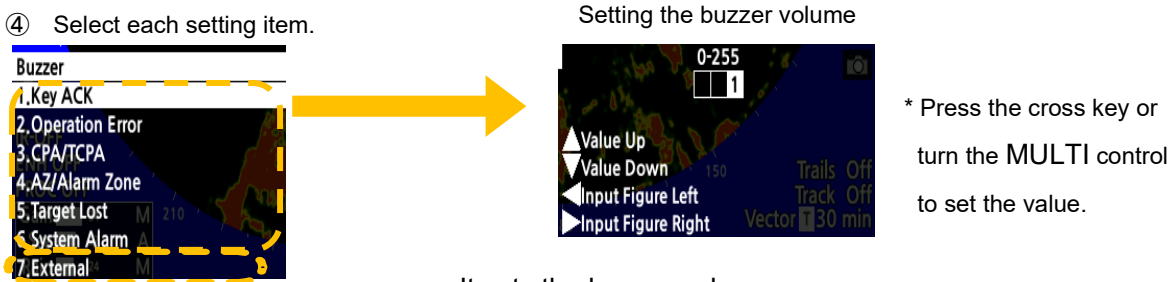
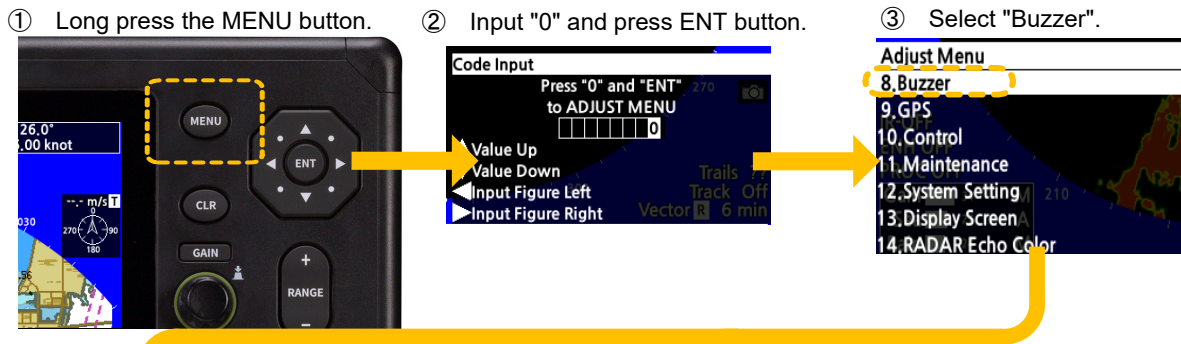

It sets the buzzer volume.  
The "0" is muted.

**Note :**  
If set to "0", you may be delay that realize the danger of the capability. And you may be mistaken not to run functions. Please set by considering enough.

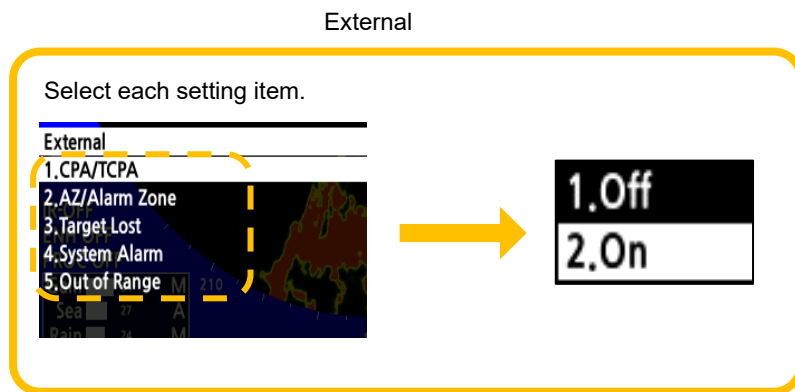

Turn on/off the buzzer in "External".

# 8.7 MAINTENANCE

Performs maintenance.

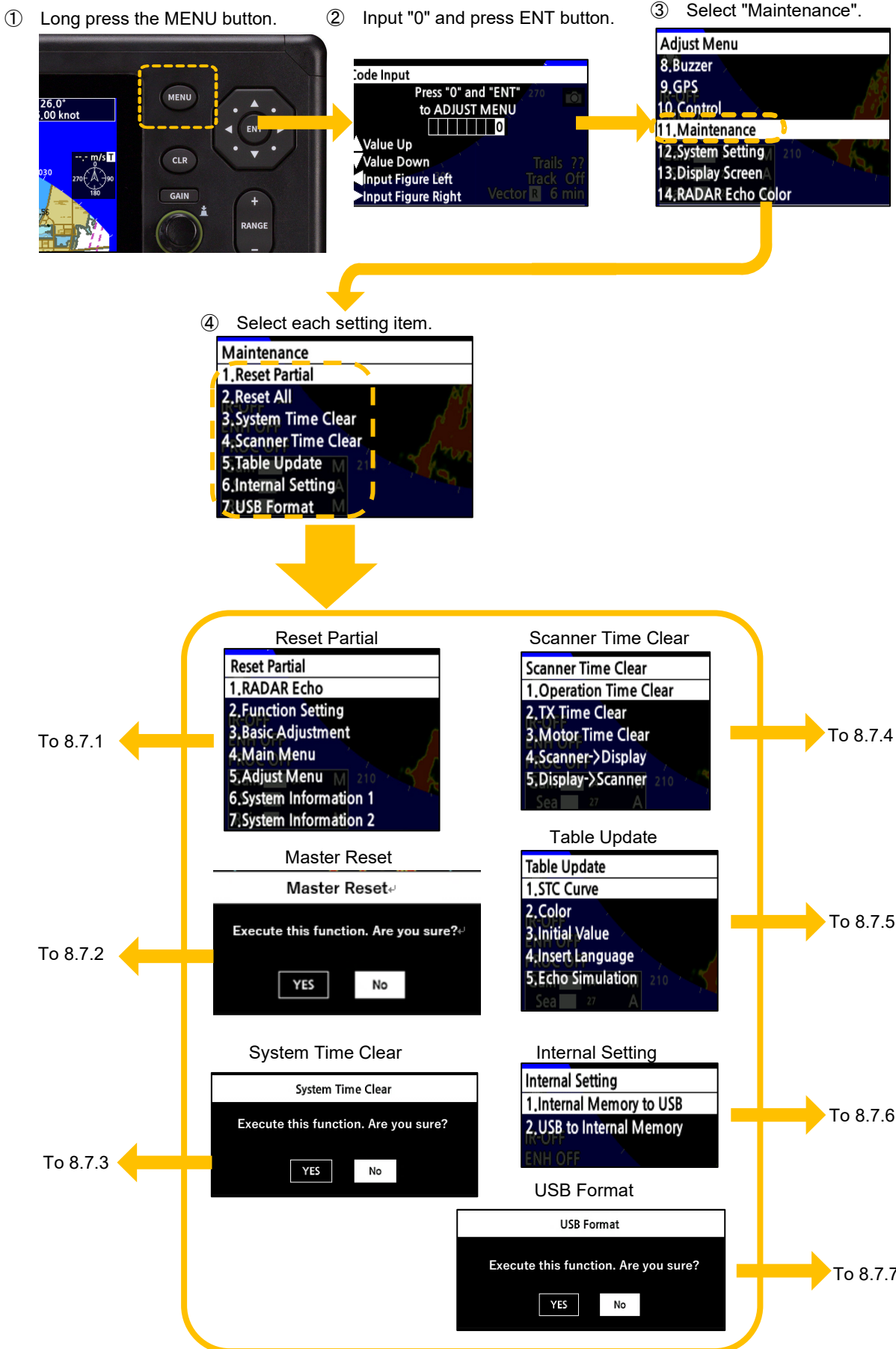



## 8.7.1 RESET PARTIAL

### CAUTION



If you press YES, the operation will be executed immediately.  
When executed, the display unit will automatically restart.  
The partial reset is the function to read out table update value (see 8.7.5).

#### Reference:

Initialization function of the reset partial is the function to read out table update value (see 8.7.5).

Select each setting item.

Items which can be reset.

RADAR Echo: Initialize the RADAR Echo settings in the Main Menu and the Initial Setting Menu.

Function Setting: Initialize the Function Settings.

Basic Adjustment: Initialize the Basic adjustment settings in the Adjust Menu.

Main Menu: Initialize the settings of the Main Menu, MULTI control menu, soft key menu and radar screen settings (except RADAR Echo and Function Setting).

Adjust Menu: Initialize the settings of Adjust Menu (except RADAR Echo and Basic Adjustment).

System Information 1: Initialize the Utility Menu.

System Information 2: Initialize the Engineer Menu.

All Menu: Initialize all settings (except marks, lines and own ship's track data).

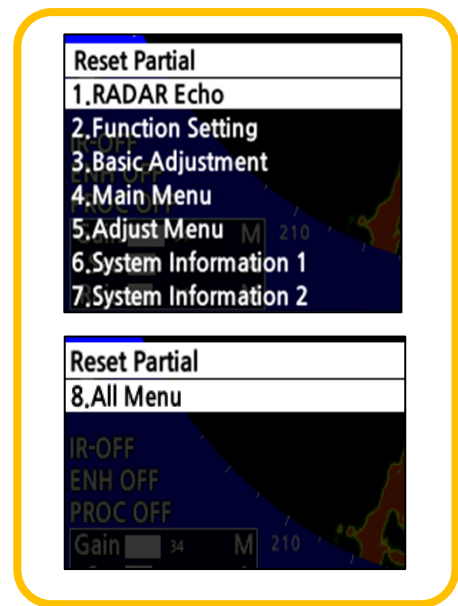

Display the dialogue.

If you press YES, the operation will be executed.

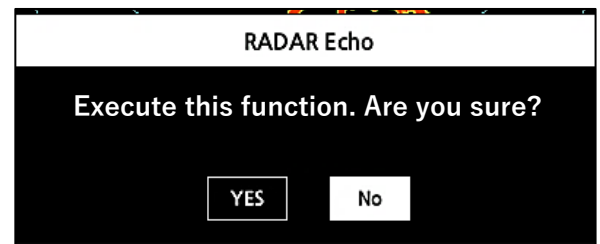

\* The same dialogue is shown about each menu.

## 8.7.2 MASTER RESET

If system operation is unstable, it may be stabilized by initializing the memory area. To initialize the memory area, the all settings become to the factory inspection settings. It is recommended that you save to USB storage internal settings before to run the "Master Reset." (see 8.7.6.1)

For your information, Mark, Line and Own Track are not deleted by "Master Reset". Please delete Mark, Line and Own Track by each menu.

 <b>CAUTION</b>	
	<p>If you press <b>YES</b>, the operation will be executed immediately. When executed, the display unit will automatically restart. Note that performing "Master Reset" erases data, such as marks/lines. "Master Reset" make to initialize the memory area, the all settings become to the factory inspection settings.</p>

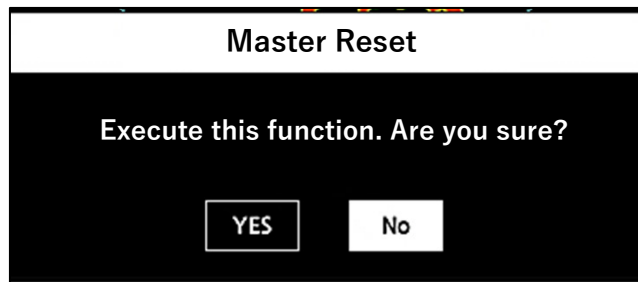

## 8.7.3 SYSTEM TIME CLEAR

 <b>CAUTION</b>	
	<p>If you press <b>YES</b>, the operation will be executed immediately.</p>

The operating time of the display unit can be initialized.

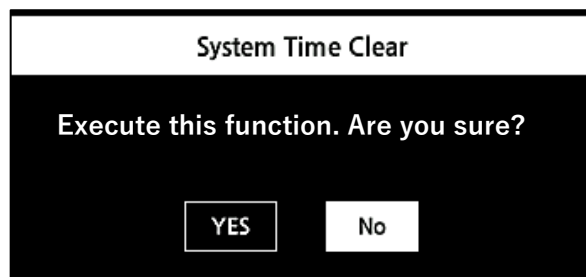

## 8.7.4 SCANNER TIME CLEAR

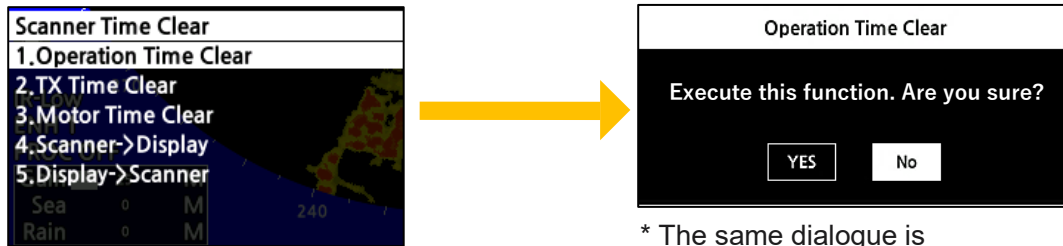

\* The same dialogue is shown about each menu.

Save the following scanner time data stored in the scanner into the display unit.

Scanner Transmit Time

Motor Rotating Time

When replacing the scanner internal control circuit, perform the procedure below to inherit scanner time data.

1. Save the scanner time data.
2. Replace the scanner internal control circuit.
3. Restore the scanner time data.

Restore the scanner time data stored in the display unit into the scanner internal control circuit.

Initialize those operating time above when magnetron or scanner motor is replaced.

### 8.7.5 TABLE UPDATE

CAUTION

The following data can be uploaded.

- STC Curve
- Color
- Initial Value
- Insert Language
- Echo Simulation

It is recommended that, when you installed the radar and the radar adjustment has been completed, run the table update by selecting of the all menu in initial value of this item. It becomes possible to restore the settings at the time of the update table by the reset partial function (see 8.5.1).

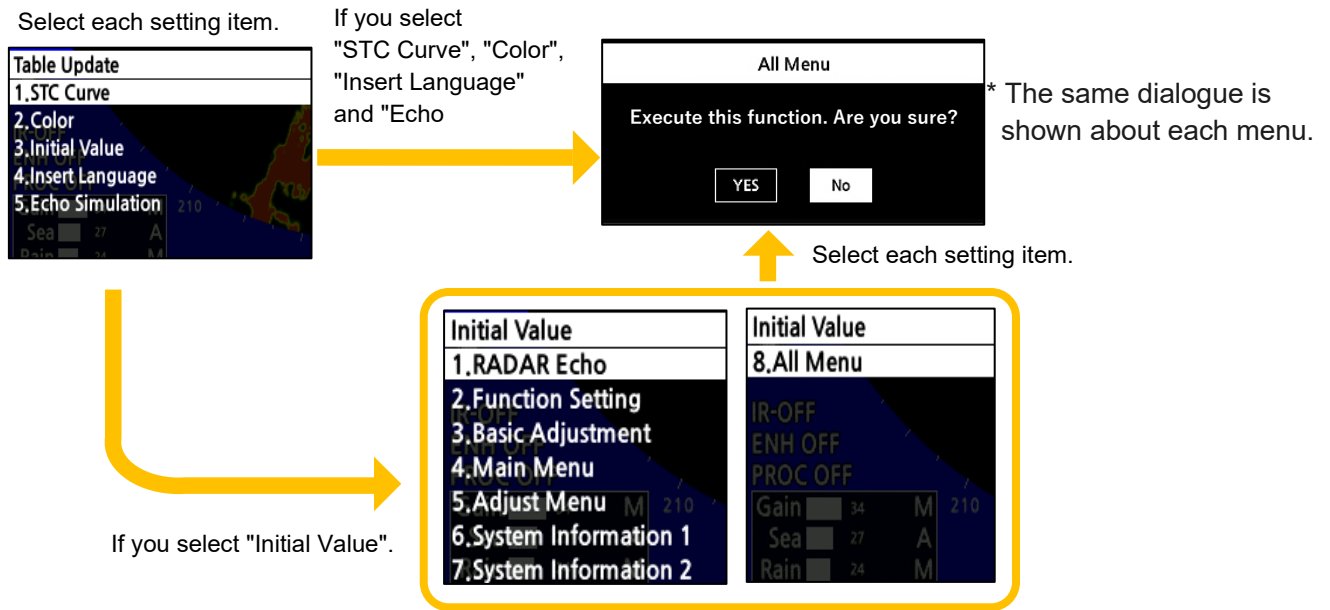

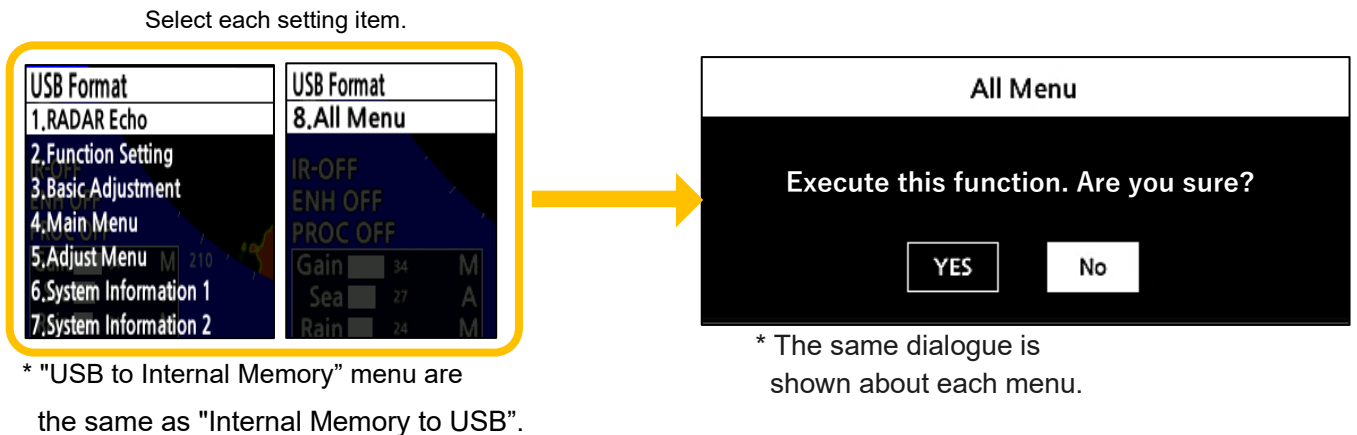

### 8.7.6 INTERNAL SETTING

You can store in the internal settings to the USB memory by using the USB port or read out the internal settings from USB memory.



### 8.7.6.1 INTERNAL MEMORY TO USB

 <b>CAUTION</b>	
	<p><b>USB flash memory is not recognized when you inserted USB flash memory from display unit power off state.</b></p> <p><b>It may take long time to access USB flash memory during transmission.</b></p> <p><b>We recommend that you use USB flash memory during stand-by.</b></p>

You can copy the system settings which were saved in the internal memory (such as various item settings of menus, etc.) to a USB flash memory. To copy the settings which were saved in the internal memory, a USB flash memory must be inserted into "USB" port on the control panel beforehand. When you replaced the processing circuit inside the display unit, you can restore the system by load the data stored in the USB flash memory and write it to the system memory.

It should be saved to USB flash memory when the system settings are completed. And we strongly recommend that you save the operating conditions to a USB flash memory on a regular basis.

Items which can be saved to a USB flash memory are following.

RADAR Echo:	RADAR Echo settings in Main Menu and Adjust Setting will be saved to the USB.
Function Setting:	Function Setting settings will be saved to the USB.
Basic Adjustment:	Basic Adjustment settings will be saved to the USB.
Main Menu:	Main Menu, MULTI control menu, and radar screen settings (except RADAR Echo and Function Setting settings) will be saved to the USB.
Adjust Setting:	Adjust Setting Menu (except RADAR Echo and Basic Adjustment settings) will be saved to the USB.
System Information 1:	Utility Menu will be saved to the USB.
System Information 2:	Engineer Menu will be saved to the USB.
All Menu:	Internal all settings will be saved to the USB.

**Note:**

When the USB flash memory is inserted, the dedicated folder to save / read the internal value will be created. However, as the capacity of the USB flash memory is large, it takes time to create the dedicated folder.

### 8.7.6.2 USB TO INTERNAL MEMORY

 <b>CAUTION</b>	
	<p><b>When executed, the display unit will automatically restart.</b></p>

Load the data stored in the USB flash memory and write it to the system internal memory. Through this operation, you can return the system to the previous operation condition after replaced the processing circuit.

### 8.7.7 USB FORMAT

 <b>CAUTION</b>	
	<b>It may take long time to access USB flash memory during transmission. We recommend that you use USB flash memory during standby.</b>
	<ul style="list-style-type: none"><li>• During formatting, please do not disconnect the USB flash memory.</li><li>• Quick format does not support.</li></ul>

Insert USB flash memory to USB port.



**Note:**

It takes time to format the USB flash memory. Format time is very similar to the time you want to format the PC.

# 8.8 SYSTEM SETTING

It not only sets the system to boot but it sets also the displayed units and own ship outline, the radar range to be used.

- ① Long press the MENU button.
- ② Input "0" and press ENT button.
- ③ Select "System Setting."

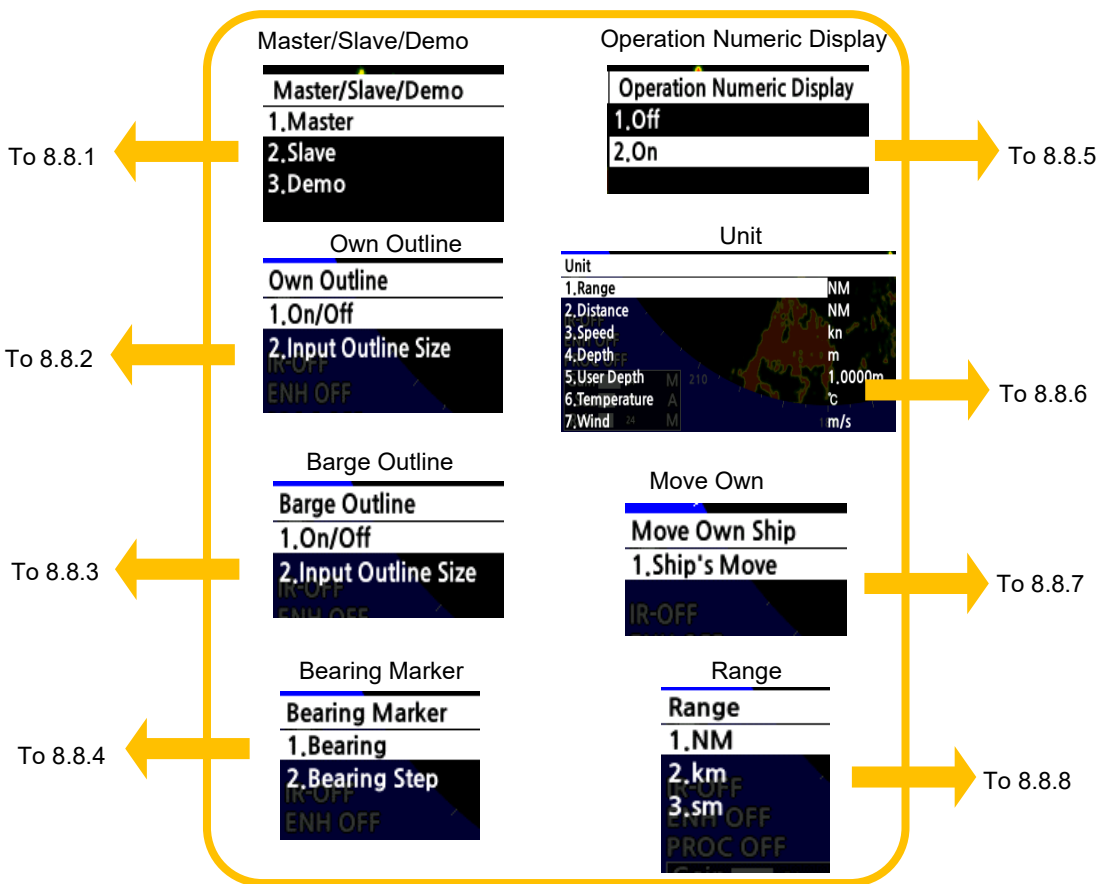
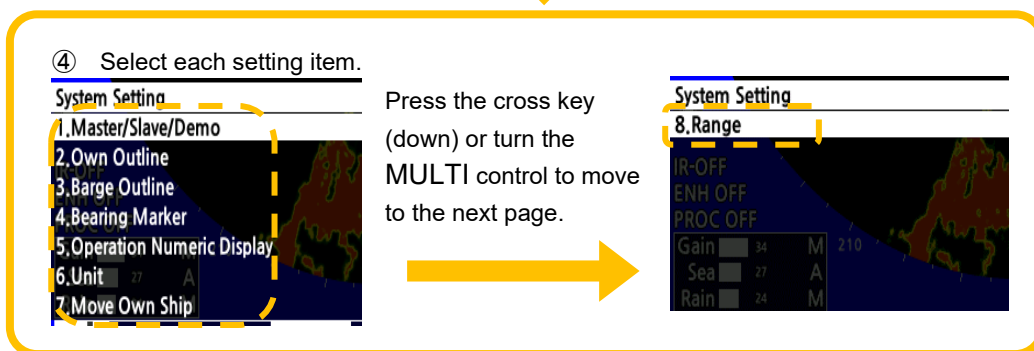
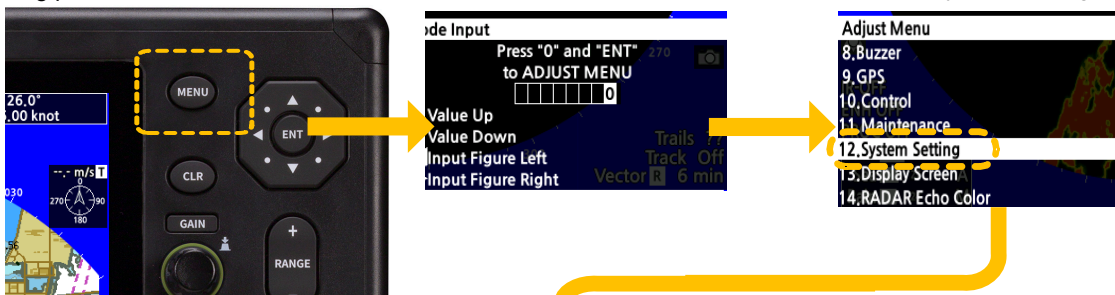

### 8.8.1 MASTER/SLAVE/DEMO

Master: Set to this item when connecting to scanner.

Slave: Set to this item when input video signal of external source to display echo without scanner.

Demo: Set to this item when no video signal is input from external source and no scanner is connected.

### 8.8.2 OWN OUTLINE

Select the own ship outline display on/off.

You can set the outline of the own ship in meters. In order to reduce the distance measurement error due to radar, please also set the installation position of the scanner.

Select each setting item.

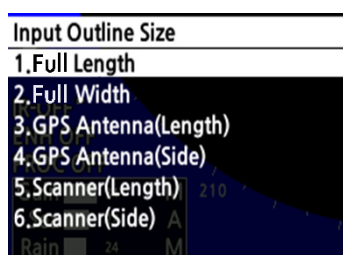

Press the cross key or turn the MULTI control to set the value.

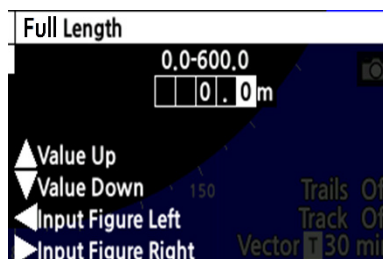

\* The same operation can be used to enter  
2. Full Width ~ 6.Scanner (side).

### 8.8.3 BARGE OUTLINE

Select the own ship outline display on/off.

You can set the outline and position of the barge ship in meters.

### 8.8.4 BEARING MARKER

Set the bearing marker to display rotated image along the bearing signal.

Select "Rotate Step" and set the unit of angle for rotating the marker.

This function only works in Head Up (H-UP) mode.

### 8.8.5 OPERATION NUMERIC DISPLAY

Turn on/off the numeric display.

If this function is turned on, numeric information is displayed when following operation performed.

EBL/VRM/Parallel Cursor/Gain/Sea/Rain/Brill/PRF fine tuning

Numeric display is disappeared after the operation.



## 8.8.6 UNIT

Set the unit that you have accustomed.

Select each setting item.

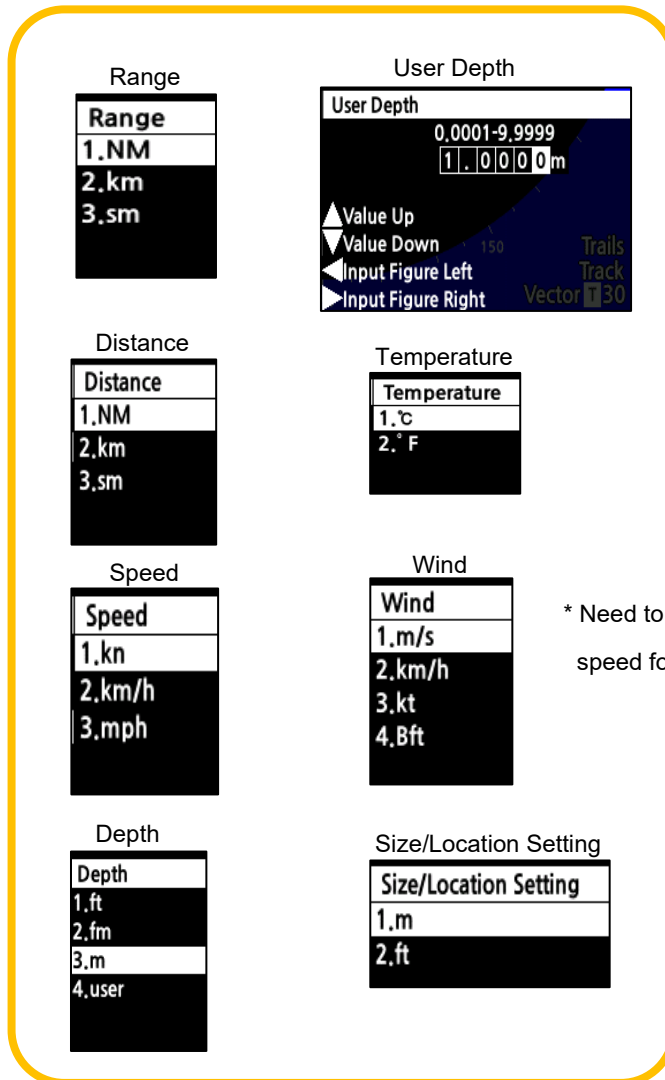
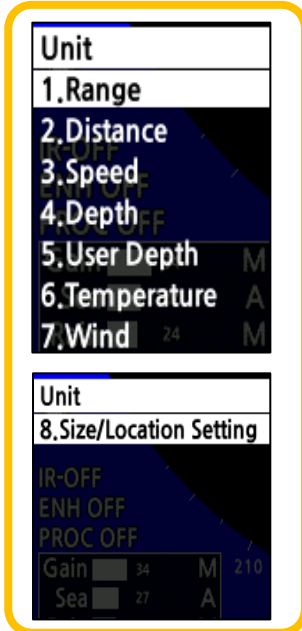

\* Need to receive True wind speed for using Bft.

## 8.8.7 MOVE OWN SHIP

It sets the used signal to a reference of how to move the ship. "Lat/Lon (latitude and longitude)" is initial value. There is no need to change it if you have a stable operation of the radar.

### 8.8.8 RANGE

Turn on/off the range display.

\* The maximum range of JMA-3404 is 48NM (48sm), and JMA-3406/HS JMA-3411 are 72NM (72sm).

Select each setting item.

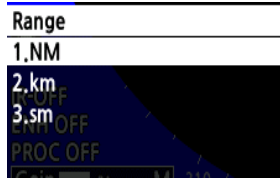

**NM**

NM	
1,0.0625NM	Off
2,0.125NM	On
3,0.25NM	On
4,0.5NM	On
5,0.75NM	On
6,1NM	Off
7,1.5NM	On
NM	
8,2NM	Off
9,3NM	On
10,4NM	Off
11,6NM	On
12,8NM	Off
13,12NM	On
14,16NM	Off
NM	
15,24NM	On
16,32NM	Off
17,48NM	On
18,64NM	Off
19,72NM	On
km	
km	
1,0.15km	Off
2,0.3km	On
3,0.5km	On
4,0.8km	On
5,1.2km	On
6,1.6km	On
7,2km	On
km	
8,4km	On
9,8km	On
10,16km	On
11,32km	On
sm	
sm	
1,0.0625sm	Off
2,0.125sm	On
3,0.25sm	On
4,0.5sm	On
5,0.75sm	On
6,1sm	Off
7,1.5sm	On
sm	
8,2sm	Off
9,3sm	On
10,4sm	Off
11,6sm	On
12,8sm	Off
13,12sm	On
14,16sm	Off
sm	
15,24sm	On
16,32sm	Off
17,48sm	On
18,64sm	Off
19,72sm	On



Select ON/OFF.

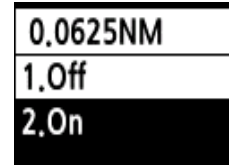

# 8.9 DISPLAY SCREEN

You can set the display screen color.

- ① Long press the MENU button.
- ② Input "0" and press ENT button.
- ③ Select "Display Screen".

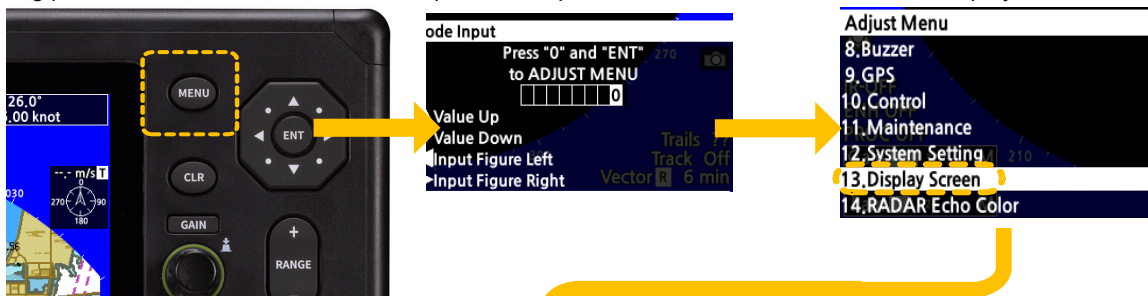

- ④ Select each setting item.

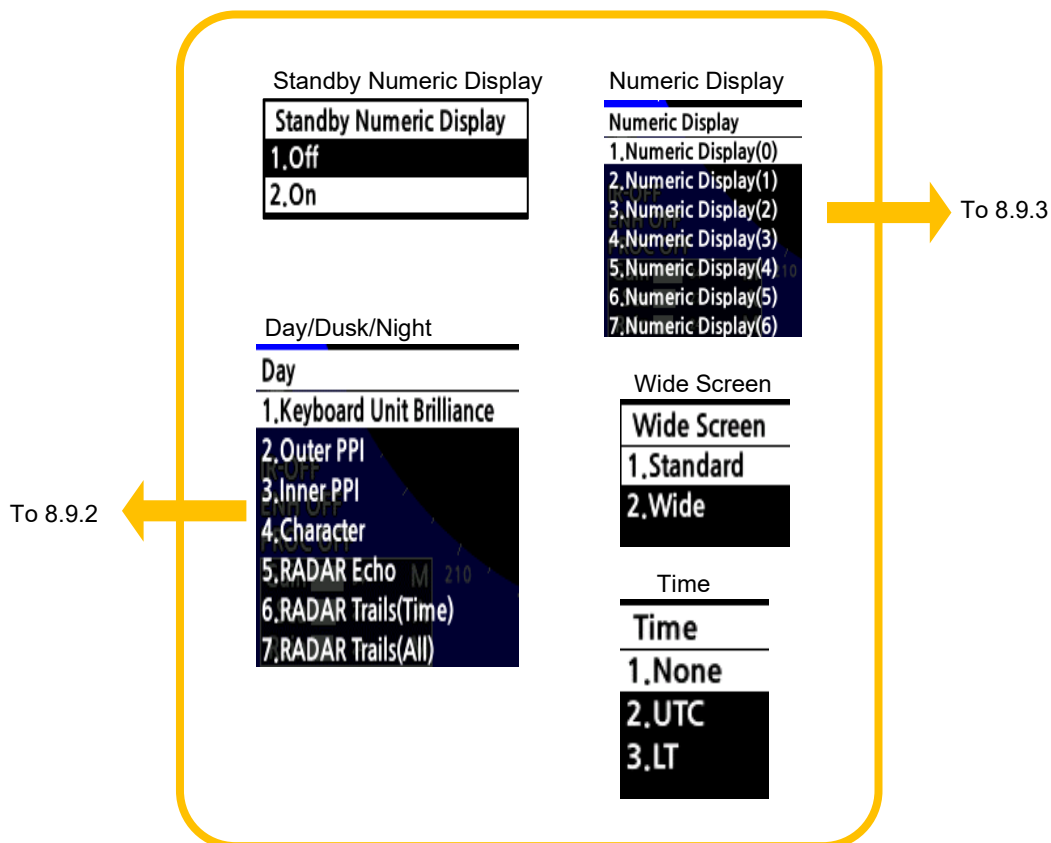
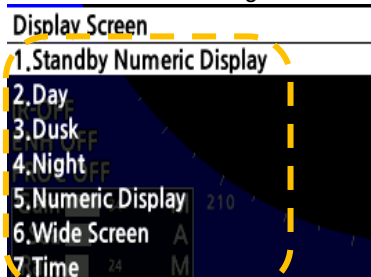

## 8.9.1 STANDBY NUMERIC DISPLAY

Switch on/off for numerical information display in standby mode.

If you turn on, numeric information is displayed in standby mode. Default is off.

Refer to “2.4.1 STANDBY SCREEN” for how to operate the standby screen.

## 8.9.2 DISPLAY COLOR

Select each setting item.

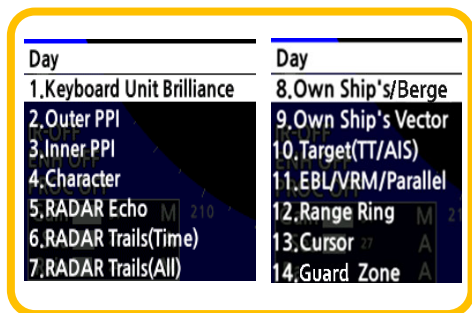

Select "Color" and "Brilliance".



\* "Keyboard Unit Brilliance" has only Brilliance setting.



The color that can be set vary depending on the item.

Dusk and Night can be set in the same way.

There is that you cannot select the color combination. For example, PPI color is black and Character color is black.

## 8.9.3 OPERATION NUMERIC DISPLAY

Set the numerical information on the screen by setting Numeric Display (0) ~ (12).

Setting each item, display will be such following image.

Set items on Numeric Display



Numeric Display is turned Off



### Reference:

When the numerical display is set, it is displayed at the following positions.

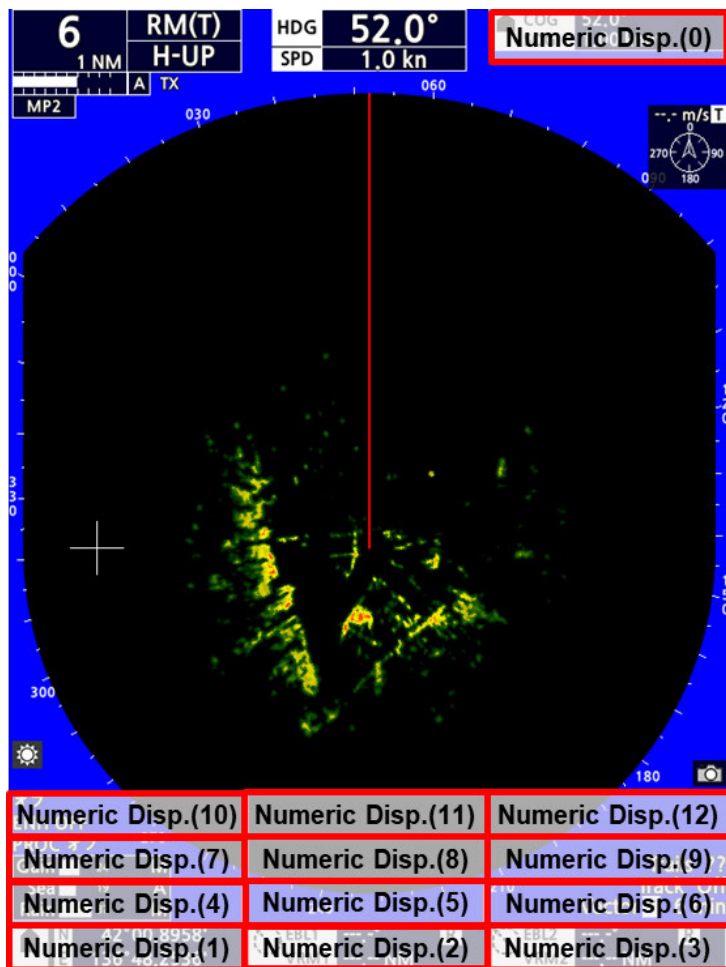

If you set item on (4) ~ (12), numerical information is displayed over the PPI. In this case, numeric information is displayed translucently.

Set items on Numeric Display (4), (5)

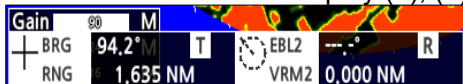

Select the display on/off in other items.

You can switch wind mode true or relative in "Wind mode."

## 8.9.4 WIDE SCREEN

Set the display of radar echo to wide.

Default is "Standard." If you select "Wide", radar echo image extend to outer PPI.

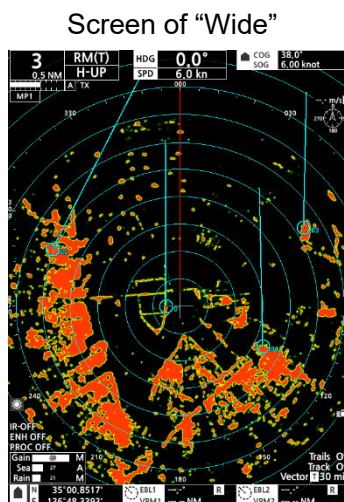
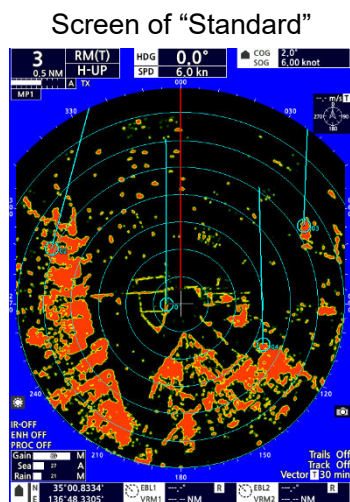

## 8.9.5 TIME

You can select the type of time to be displayed when a ZDA sentence is received.

Set the kind of time displayed.

You can select display time from "UTC", "LT", "None." Time display is not shown if you set "None."

# 8.10 RADAR ECHO COLOR

Set the color of radar image.

Adjust the color so that easy to see while checking the display.

① Long press the MENU button.



② Input "0" and press ENT button.

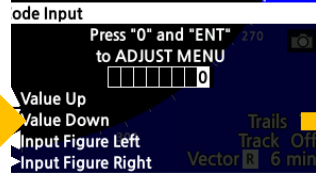

③ Select "RADAR Echo Color".

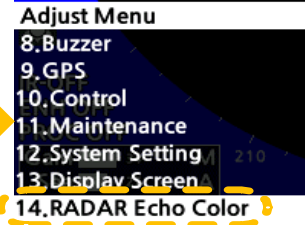

④ Select each setting item.

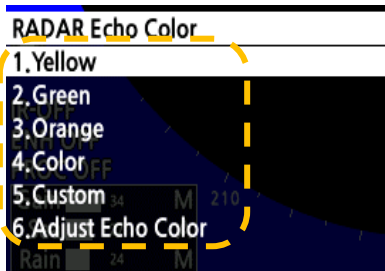

<p>Yellow</p> <hr/> <p>Yellow</p> <p>1. Yellow1</p> <p>2. Yellow2</p> <p>3. Yellow3</p>	<p>Orange</p> <hr/> <p>Orange</p> <p>1. Orange</p> <p>2. Orange</p> <p>3. Orange</p>	<p>Custom</p> <hr/> <p>Custom</p> <p>1. Custom 1</p> <p>2. Custom 2</p> <p>3. Custom 3</p>
<p>Green</p> <hr/> <p>Green</p> <p>1. Green 1</p> <p>2. Green 2</p> <p>3. Green 3</p>	<p>Color</p> <hr/> <p>Color</p> <p>1. Color 1</p> <p>2. Color 2</p> <p>3. Color 3</p>	<p>Adjust Echo Color</p> <hr/> <p>Adjust Echo Color</p> <p>1. Pattern 1</p> <p>2. Pattern 2</p> <p>3. Pattern 3</p>

# 8.11 ERROR ALARM MASK

Even if error is detected, it can be set not to display an error on the screen.

⚠ CAUTION

!

Do not change the setting value carelessly.

When alarm detection is turned off or the detection time is changed, it is serious alarm occurs or possibilities delay in alarm occurrence etcetera.

- ① Long press the MENU button.
- ② Input "0" and press ENT button.
- ③ Turn the cross key (down) or the MULTI control right to move the page and select "Error Alarm Mask".

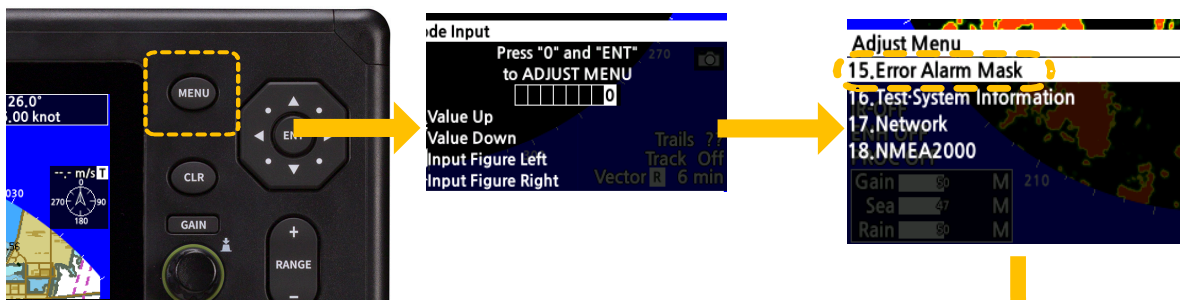

- ④ Select each setting item.

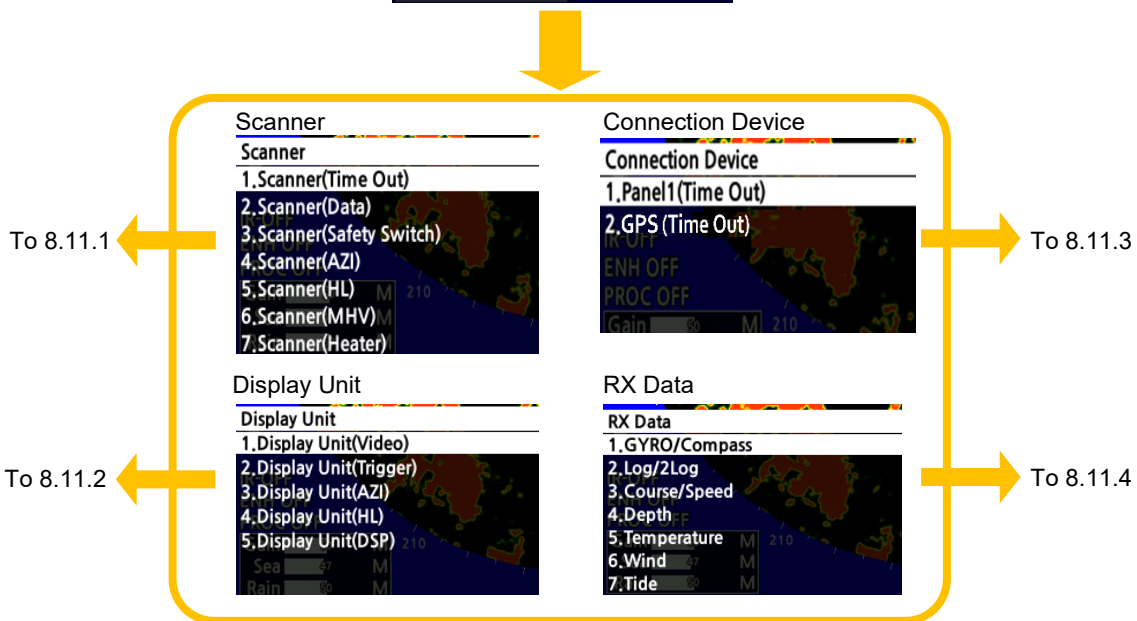
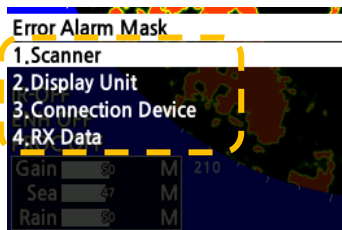



## 8.11.1 SCANNER

Select each setting item



Select an item and change the setting.

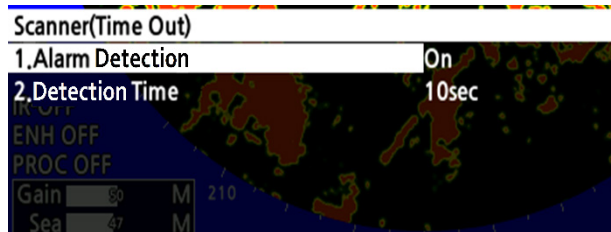

\*The setting items that are displayed are the same even if you select something other than "Scanner(Time Out)".

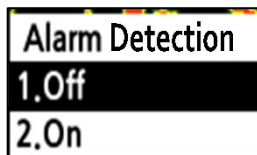

Alarm Detection

On: An abnormal condition is detected and an alarm is generated.

Off: An alarm does not occur.



"Detection Time" the time from when an abnormality is detected until an alarm occurs.

You can set between 0 and 999 seconds. 0 second dose not occur an alarm.

If a normal condition is detected within a set time after an error is detected, no alarm is generated.

### Note :

The communication cycle for reporting the status varies depending on the device.

If a detection time shorter than the communication cycle is set, an abnormal condition may be recognized incorrectly.

## 8.11.2 DISPLAY UNIT

Set alarm detection for the Display Unit.



The contents that can be set by selecting each item and the operation method are the same as for 8.11.1 SCANNER.

### 8.11.3 CONNECTION DEVICE

Set alarm detection for the Connection Device.

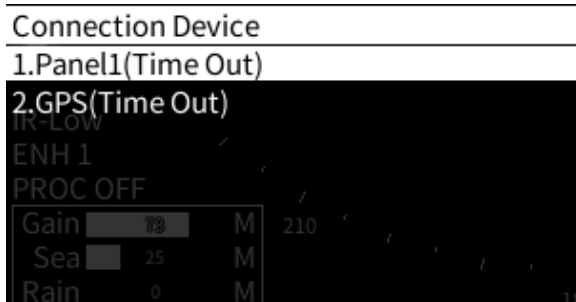

The contents that can be set by selecting each item and the operation method are the same as for 8.11.1 SCANNER.

### 8.11.4 RX DATA

Set alarm detection for the RX Data.

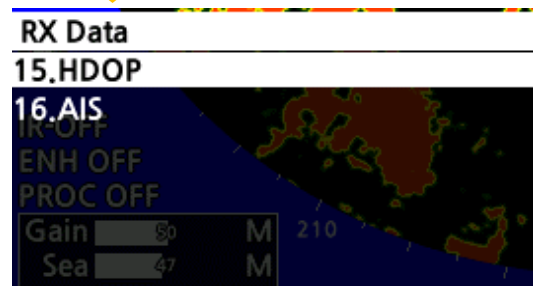
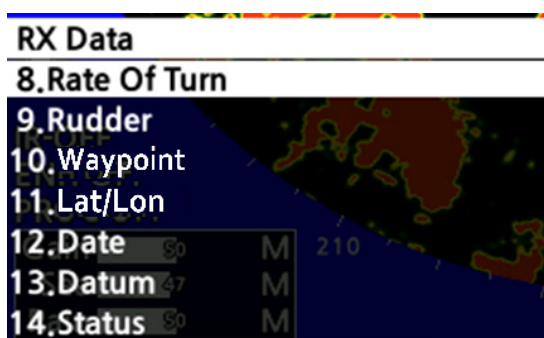

Press the cross key (down) or turn the MULTI control to move to the next page.

The contents that can be set by selecting each item and the operation method are the same as for 8.11.1 SCANNER.

## 8.12 NETWORK

**Note:** This function was implemented for the display software Ver.3.07 or later.

The Network function is used for the display and operation of one antenna with two display units and the transmission of radar echoes.

Example: connection

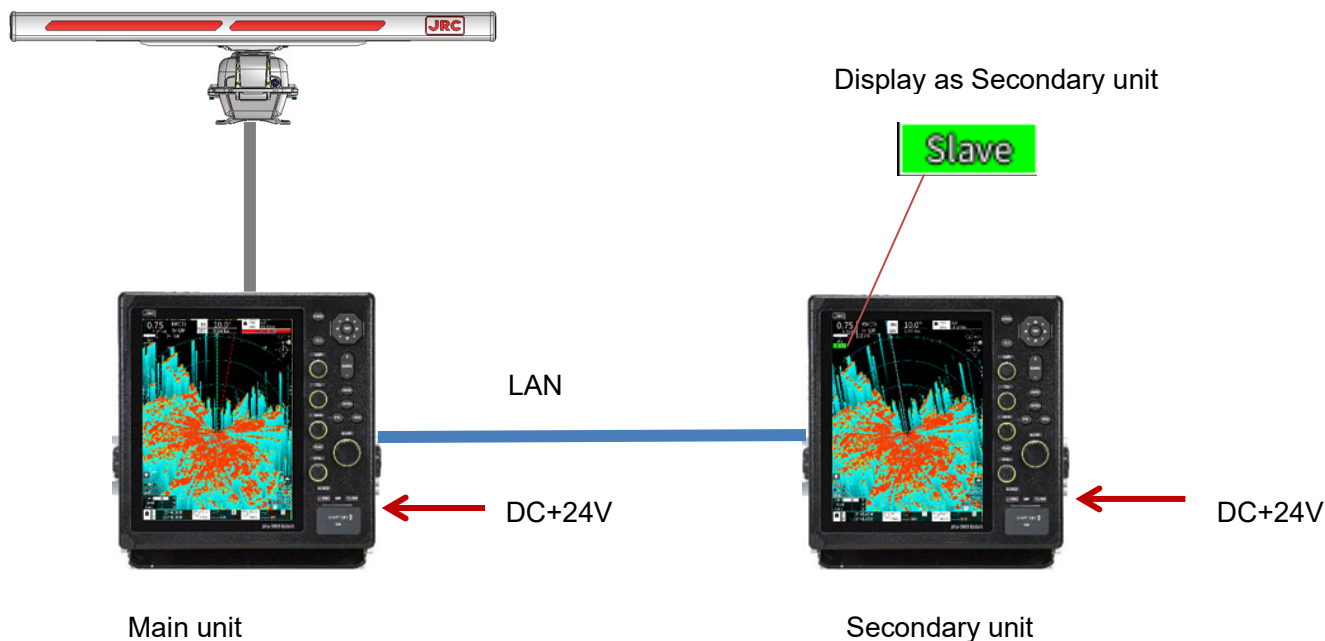

After network function setup, the secondary unit can also use the following functions. The functions synchronize with main unit.

- TX   • TX-off   • Standby screen   • The radar range   • Radar echo setting   • Function setting
- Trail Length   • SEA control   • RAIN control   • GAIN control   • Tuning

The following functions cannot use at the secondary unit.

- TT   • Guard Zone   • MOB   • Anchor watch   • Vector Length   • Off center

※Other unavailable menus are forced to be grayed out.

The following function also needs to input data the secondary unit.

- AIS displaying function

The map function of the secondary unit need a map card(newpec or navionics+) on the secondary unit, too.

## 8.12.1 NETWORK SETTING

### SETTING PROCEDURE

1. Set the Multicast IP address of display unit.  
(Multicast IP address set the same number to main display unit and secondary display unit.)
2. Turn on the function of radar echo transmission on main and secondary display unit.
3. Set the IP address of display unit.  
(Set different IP addresses for the main and secondary display unit.)
4. Turn on the network function on main and secondary display unit.
5. Set the secondary unit to the slave.  
(Menu location is "Adjust Menu/12.System Setting/1.Master/Slave/Demo".)

Show below the menu for using the network setting.

- ① Long press the MENU button.
- ② Input "0" and press ENT button.
- ③ Press the cross key (down) or turn the MULTI control right to move the page and select "Network".

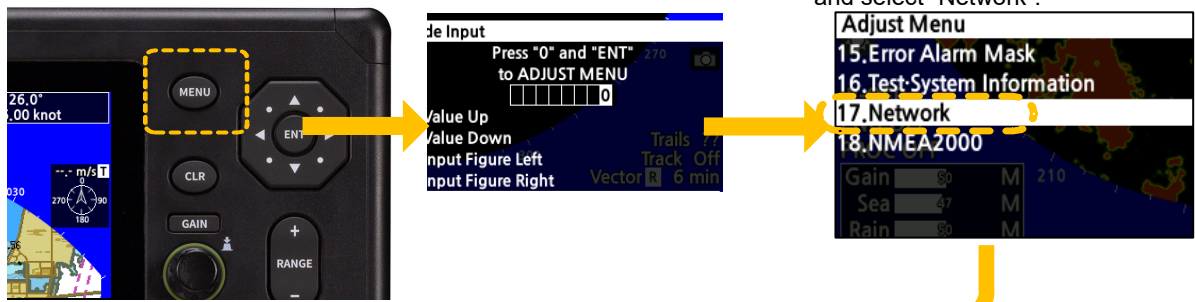

- ④ Select each setting item.

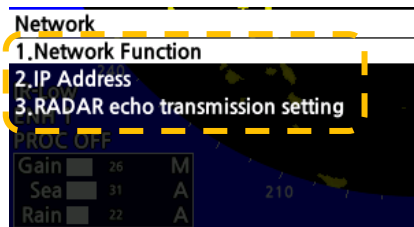

1.Network Function	3.RADAR echo transmission setting																		
<table border="1" style="width: 100%; border-collapse: collapse;"> <thead> <tr> <th>Network</th> <th>Network Function</th> </tr> </thead> <tbody> <tr> <td>1.Network Function</td> <td>1.Off</td> </tr> <tr> <td>2.IP Address</td> <td>2.On</td> </tr> <tr> <td>3.RADAR echo transmission setting</td> <td></td> </tr> </tbody> </table>	Network	Network Function	1.Network Function	1.Off	2.IP Address	2.On	3.RADAR echo transmission setting		<table border="1" style="width: 100%; border-collapse: collapse;"> <thead> <tr> <th colspan="2">RADAR echo transmission setting</th> </tr> </thead> <tbody> <tr> <td>1.RADAR echo transmission function</td> <td>Off</td> </tr> <tr> <td>2.Multicast IP</td> <td>239.0.17.1</td> </tr> <tr> <td>3.Output Form</td> <td>Quadrant</td> </tr> <tr> <td>4.Data Format</td> <td>Normal</td> </tr> </tbody> </table>	RADAR echo transmission setting		1.RADAR echo transmission function	Off	2.Multicast IP	239.0.17.1	3.Output Form	Quadrant	4.Data Format	Normal
Network	Network Function																		
1.Network Function	1.Off																		
2.IP Address	2.On																		
3.RADAR echo transmission setting																			
RADAR echo transmission setting																			
1.RADAR echo transmission function	Off																		
2.Multicast IP	239.0.17.1																		
3.Output Form	Quadrant																		
4.Data Format	Normal																		
<table border="1" style="width: 100%; border-collapse: collapse;"> <thead> <tr> <th>Network</th> <th>IP Address</th> </tr> </thead> <tbody> <tr> <td>1.Network Function</td> <td>Input XXX.XXX.XXX.XXX</td> </tr> <tr> <td>2.IP Address</td> <td>192.168.060.011</td> </tr> <tr> <td>3.RADAR echo transmission setting</td> <td></td> </tr> </tbody> </table>	Network	IP Address	1.Network Function	Input XXX.XXX.XXX.XXX	2.IP Address	192.168.060.011	3.RADAR echo transmission setting												
Network	IP Address																		
1.Network Function	Input XXX.XXX.XXX.XXX																		
2.IP Address	192.168.060.011																		
3.RADAR echo transmission setting																			

To 8.12.2
To 8.12.3
To 8.12.4

Example) Setting the IP Address and the Multicast IP.

**Main unit**

① Set the IP Address to 192.168.060.001

Network	
1.Network Function	Input XXX.XXX.XXX.XXX
2.IP Address	192.168.060.001
3.RADAR echo transmission setting	

↓

② Set the Multicast IP to 239.000.017.001

RADAR echo transmission setting	
1.RADAR echo transmission function	Input XXX.XXX.XXX.XXX
2.Multicast IP	239.000.017.001
3.Output Form	
4.Data Format	

↓

③ Turn on the radar echo transmission.

RADAR echo transmission setting	
1.RADAR echo transmission function	1.Off
2.Multicast IP	2.On
3.Output Form	
4.Data Format	

↓

④ Turn on the network function

Network	
1.Network Function	1.Off
2.IP Address	2.On
3.RADAR echo transmission setting	

**Secondary unit**

⑤ Set the IP Address to 192.168.060.002

Network	
1.Network Function	Input XXX.XXX.XXX.XXX
2.IP Address	192.168.060.002
3.RADAR echo transmission setting	

↓

⑥ Set the Multicast IP to 239.000.017.001

※ Set the same address as the main display unit.

RADAR echo transmission setting	
1.RADAR echo transmission function	Input XXX.XXX.XXX.XXX
2.Multicast IP	239.000.017.001
3.Output Form	
4.Data Format	

↓

⑦ Turn on the radar echo transmission.

RADAR echo transmission setting	
1.RADAR echo transmission function	1.Off
2.Multicast IP	2.On
3.Output Form	
4.Data Format	

↓

⑧ Turn on the network function

Network	
1.Network Function	1.Off
2.IP Address	2.On
3.RADAR echo transmission setting	

Can be set from either the main unit or the secondary unit.

At the last, Set the secondary unit to the slave by “Adjust Menu/12.System Setting/1Master/Slave/Demo”.

※ When the network connection is complete, the “Slave” part of the secondary unit lights up green on the left upper side of screen.

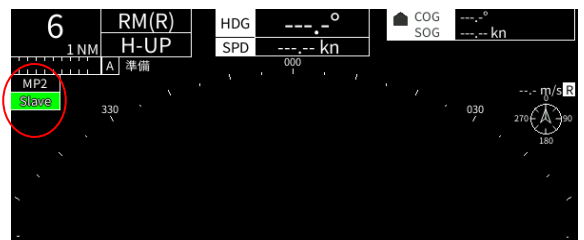

## 8.12.2 NETWORK FUNCTION

Toggle Network Function on and off.

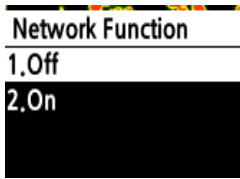

## 8.12.3 IP ADDRESS

Set the IP Address of display unit.

Valid only when the 8.12.1 NETWORK FUNCTION is on.

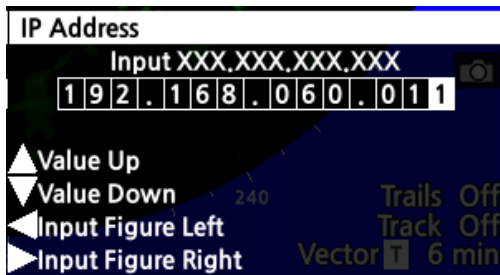

## 8.12.4 RADAR ECHO TRANSMISSION SETTING

Set the transmission of radar echo image.

Valid only when the 8.12.1 NETWORK FUNCTION is on.

Select each setting item.

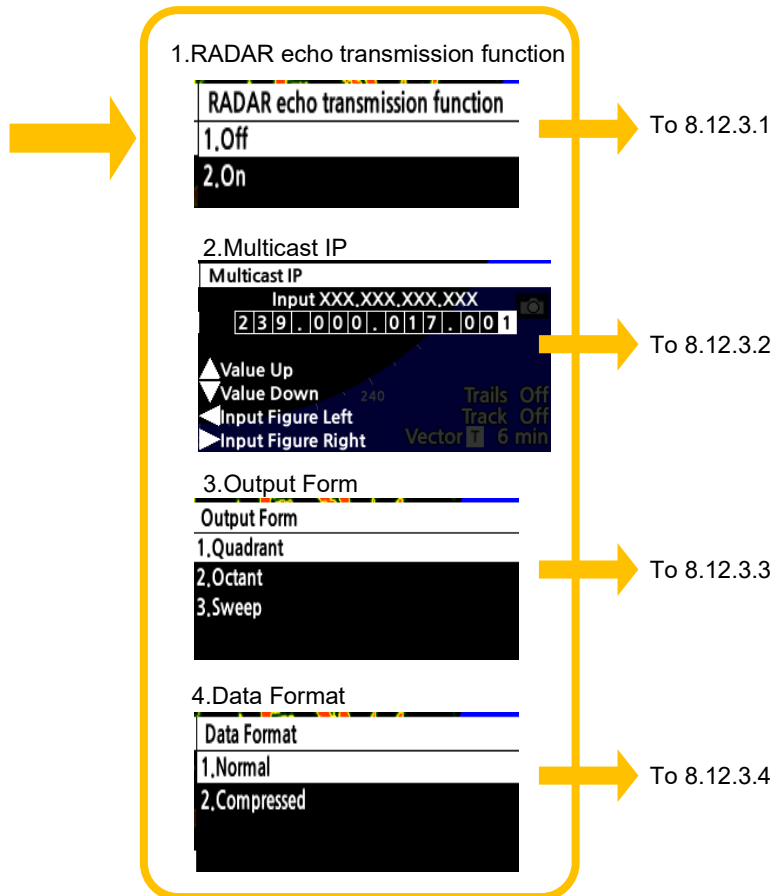
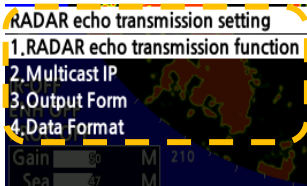

### 8.12.4.1 RADAR ECHO TRANSMISSION FUNCTION

Set the On/Off of radar echo transmission function.

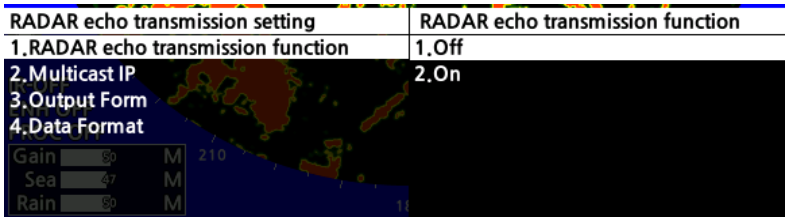

### 8.12.4.2 MULTICAST IP

Set the Multicast IP of radar echo transmission.

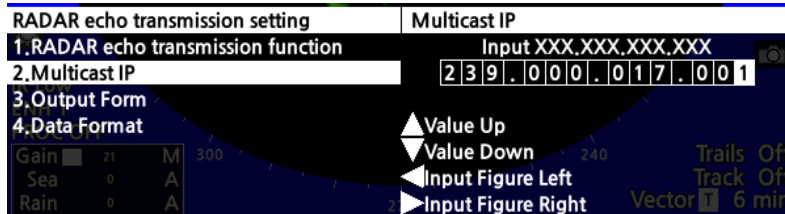

### 8.12.4.3 OUTPUT FORM

Set the Output Form of radar echo transmission.

※Cannot change the settings.

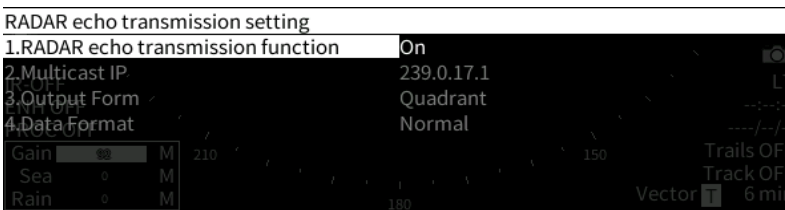

### 8.12.4.4 DATA FORMAT

Set the Data Format of radar echo transmission.

※Cannot change the settings.

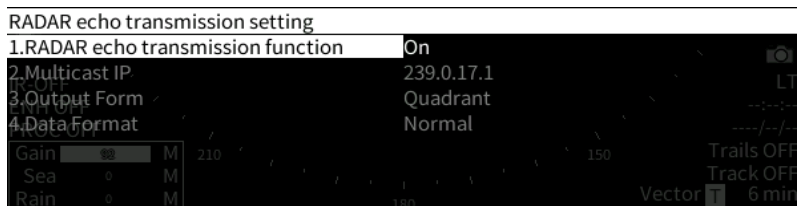

## 8.13 CAN

Set the CAN. (This radar display unit supports partly NMEA2000, not compliant fully NMEA2000, and not also fully IEC61162-3. Thus, we are describing “CAN” in this manual.)

To use CAN with the JMA-3400 series, a CAN cable (optional or commercial) is required.

- ① Long press the MENU button.
- ② Input "0" and press ENT button.
- ③ Turn the cross key (down) or the MULTI control right to move the page and select “NMEA2000”.

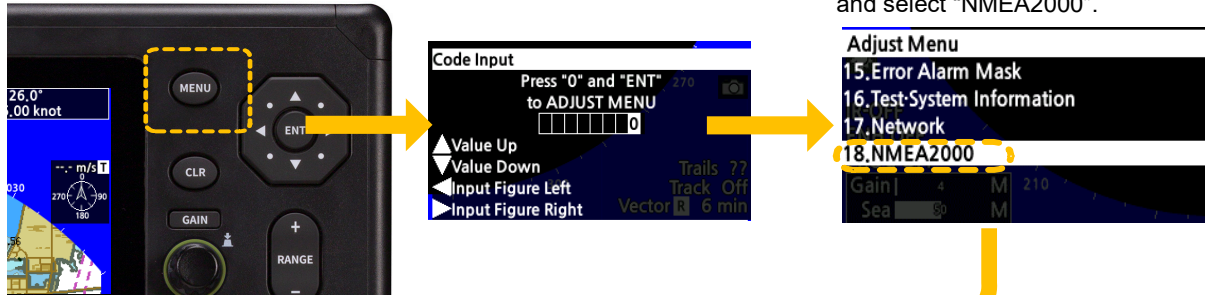

- ④ Select each setting item.

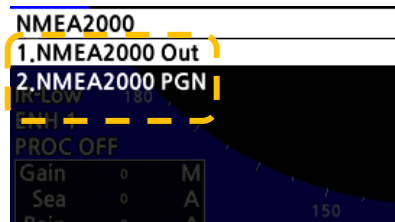

CAN Out	CAN PGN
NMEA2000 Out	NMEA2000 PGN
1. Off	1. Water Speed (128259) Off
2. On	2. Water depth (128267) Off
	3. XTE (129283) Off
	4. NAV. data (129284) Off
	5. NAV. Route/WP data (129285) Off
	6. COG & SOG (129026) Off
	7. GNSS position (129029) Off

← To 8.13.1
→ To 8.13.2

### 8.13.1 CAN OUT

Set whether to output CAN Out.

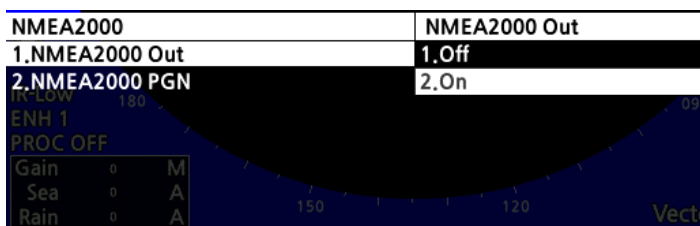



### 8.13.2 CAN PGN

Set whether to use this equipment for each CAN PGN.

For CAN PGN supported by this device, refer to 13.7 I/O SIGNALS.

Select each setting item.

NMEA2000 PGN	
1. Water Speed (128259)	
2. Water depth (128267)	
3. XTE (129283)	
4. NAV. data (129284)	
5. NAV. Route/WP data (129285)	
6. COG & SOG (129026)	
7. GNSS position (129029)	

Change ON / OFF.

NMEA2000 PGN	Water Speed (128259)
1. Water Speed (128259)	1. Off
2. Water depth (128267)	2. On
3. XTE (129283)	
4. NAV. data (129284)	
5. NAV. Route/WP data (129285)	
6. COG & SOG (129026)	
7. GNSS position (129029)	

Press the cross key (down) or turn the MULTI control to move to the next page.

\*The setting items that are displayed are the same even if you select something other than "Water Speed."

NMEA2000 PGN	
8. Water temp (130310)	
IR-OFF	
ENH OFF	
PROC OFF	
Gain   4 M 210	
Sea   M	
Dist   M	

# Chapter 9 TRUE OR FALSE ECHOS ON DISPLAY

The radar operator has a role of interpreting the radar displays to provide his best aid in maneuvering the ship. For this purpose, the operator has to observe the radar displays after fully understanding the advantages and disadvantages that the radar has.

For better interpretation of radar display, it is important to gain more experiences by operating the radar equipment in fair weathers and comparing the target ships watched with the naked eyes and their echoes on the radar display.

The radar is mainly used to monitor the courses of own ship and other ships in open seas, to check buoys and other nautical marks when entering a port, to measure own ship's position in the coastal waters relative to the bearings and ranges of the shore or islands using a chart, and to monitor the position and movement of a heavy rain if it appears on the radar display. Various types of radar display will be explained below.

## 9.1 RADAR WAVE WITH THE HORIZON

Radar beam radiation has the nature of propagating nearly along the curved surface of the earth. The propagation varies with the property of the air layer through which the radar beam propagates. In the normal propagation, the distance (D) of the radar wave to the horizon is approximately 10% longer than the distance to the optical horizon. The distance (D) is given by the following formula:

$$D = 2.23(\sqrt{h_1} + \sqrt{h_2}) \text{ (nm)}$$

$h_1$ : Height (m) of radar scanner above sea level

$h_2$ : Height (m) of a target above sea level

Fig. 9-1-1 is a diagram for determining the maximum detection range of a target that is limited by the curve of the earth surface in the normal propagation.

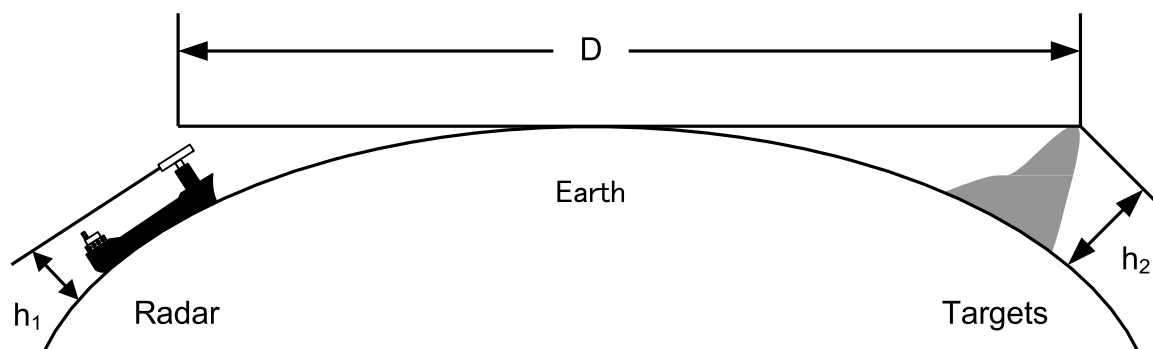
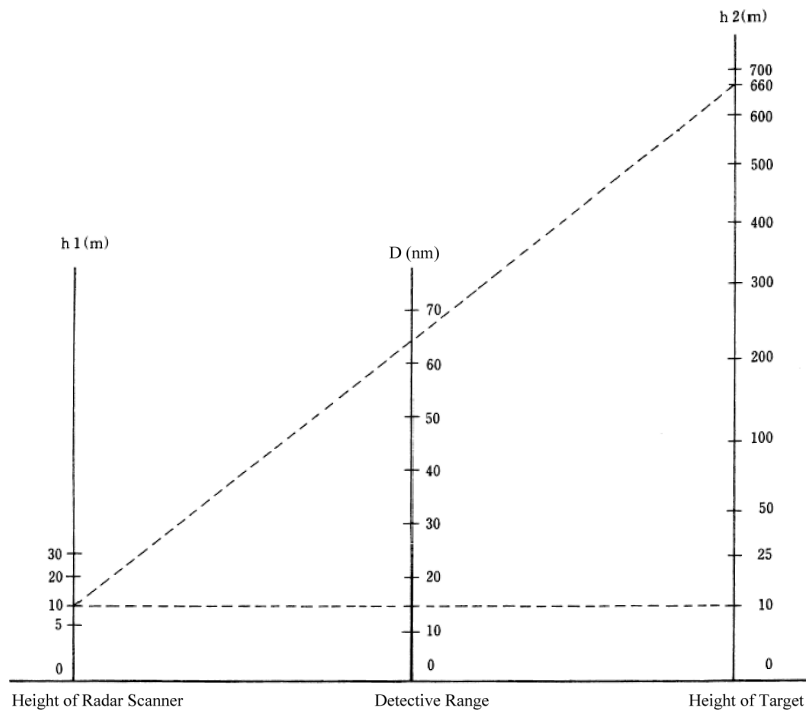

Fig. 9-1-1



When the height of own ship's scanner is 10 m for instance,

- A target that can be detected at the radar range of 64 NM on the radar display is required to have a height of 660 m or more.
- If the height of a target is 10 m, the radar range has to be approx. 15 NM.

However, the maximum radar range at which a target can be detected on the radar display depends upon the size of the target and the weather conditions, that is, the radar range may increase or decrease depending upon those conditions.

## 9.2 REFLECTION FROM TARGET

The signal intensity reflected from a target depends not only on the height and size of the target but also on its material and shape. The echo intensity from a higher and larger target is not always higher in general. In particular, the echo from a coast line is affected by the geographic conditions of the coast. If the coast has a very gentle slope, the echo from a mountain of the inland appears on the radar display, as shown in Fig. 9-1-2. Therefore, the distance to the coast line should be measured carefully.

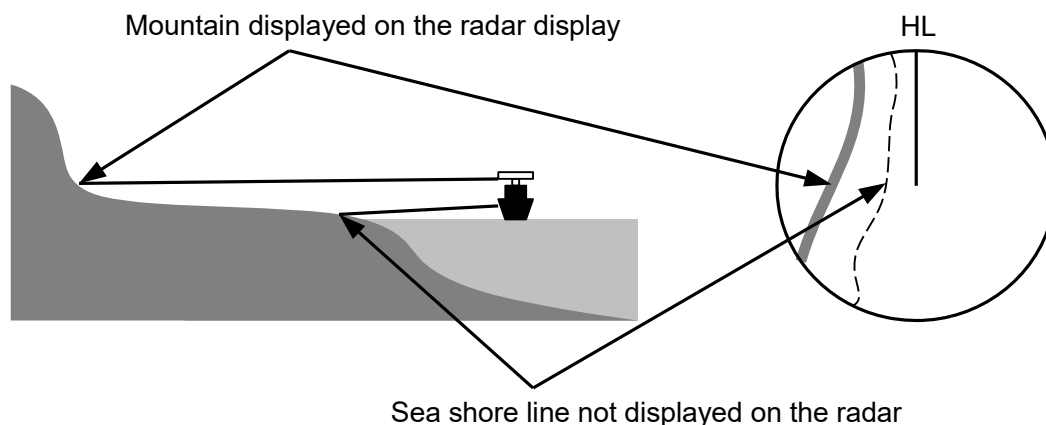

Fig. 9-1-2

## 9.3 SEA CLUTTER AND RAIN AND SNOW CLUTTER

In addition to the echo required for observing ships and land radar video image also includes unnecessary echo, such as reflection from waves on the sea surface and reflection from rain and snow. Reflection from the sea surface is called "sea clutter," and reflection from rain and snow is called "rain and snow clutter," and those spurious waves must be eliminated by the clutter rejection function.

### 9.3.1 SEA CLUTTER

Sea clutter appears as an image radiating outwardly from the center of the radar display and changing depending on the size and the shape of waves. Generally, as waves become larger, image level of the sea clutter is intensified and the clutter far away is also displayed. When waves are large and the sea clutter level is high, it is difficult to distinguish sea clutter from a small boat whose reflection intensity is weak.

### 9.3.2 RAIN AND SNOW CLUTTER

Rain and snow clutter is a video image that appears in a location where rain or snow is falling. The image changes according to the amount of rain (or the amount of snowfall). As precipitation increases, the image of rain and snow clutter becomes intensified on the radar display, and in the case of localized heavy rain, an image similar to the image indicating land is displayed in some cases. Furthermore, because radio waves tend to attenuate due to rain and snow, the ability to detect a target in the rain and snow clutter or a target beyond the rain and snow clutter may decrease.

### 9.3.3 COPING WITH SEA CLUTTER AND RAIN AND SNOW CLUTTER

When the weather is bad and the ocean is rough, reducing the pulse width will reduce the influence by spurious waves, and also the spurious wave rejection function effectively works; therefore, the use of short pulse is effective when the weather is bad. By using image processing functions "3Scan CORREL" to "5Scan CORREL", it is expected that spurious waves are further suppressed. Since optimal settings for those items can be automatically made by using the function mode, it is recommended that STORM or RAIN be used by selecting the function mode when the weather is bad. For details of the function mode, see Section "5.13 MODE FUNCTION" and "5.2.3 FUNCTION SETTING".

However, these functions may make some targets invisible, particularly targets with higher speeds.

## 9.4 FALSE ECHOES

The radar observer may be embarrassed with some echoes that do not exist actually. These false echoes appear by the following causes that are well known:

### 9.4.1 SHADOW

When the radar scanner is installed near a funnel or mast, the echo of a target that exists in the direction of the funnel or mast cannot appear on the radar display because the radar beam is reflected on the funnel or mast. Whether there are some false echoes due to shadows can be checked monitoring the sea clutter returns, in which there may be a part of weak or no returns. Such shadows appear always in the same directions, which the operator should have in mind in radar operation.

### 9.4.2 SIDE LOBE EFFECT

A broken-line circular arc may appear at the same range as the main lobe of the radar beam on the radar display. This type of false echo can easily be discriminated when a target echo appears isolated. (See Fig. 9-4-2-1)

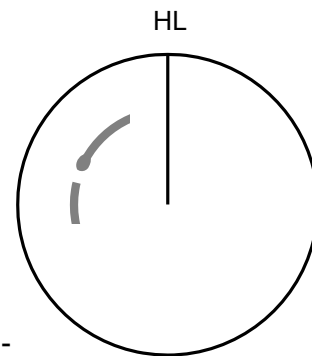

Fig. 9-4-

2-1

### 9.4.3 FALSE ECHO BY SECONDARY REFLECTION

When a target exists near own ship, two echoes from the single target may appear on the radar display. One of those echoes is the direct echo return from the target and the other is the secondary reflection return from a mast or funnel that stands in the same direction as shown in Fig. 9-4-3-1.

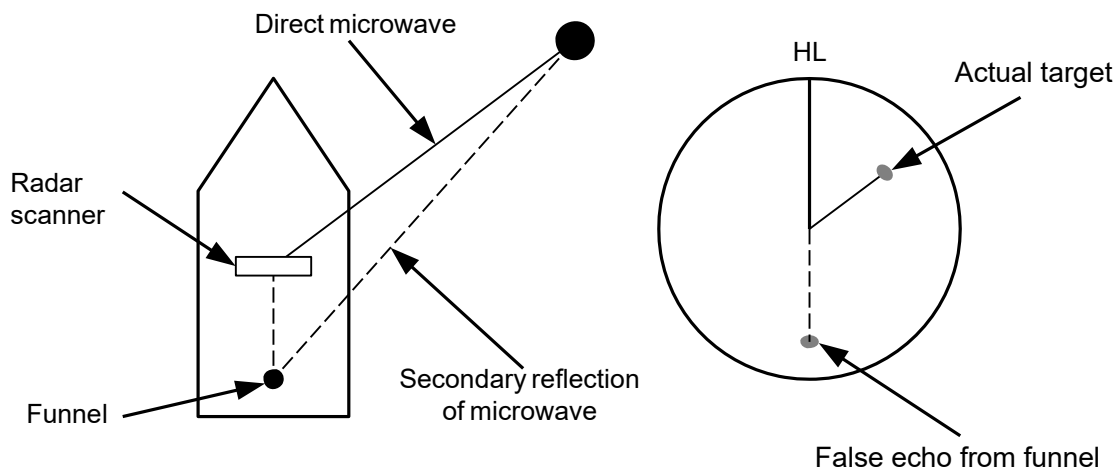

Fig. 9-4-3-1

### 9.4.4 FALSE ECHO BY MULTIPLE REFLECTION

When there is a large structure or ship with a high vertical surface near own ship as shown in Fig. 9-4-4-1, multiple reflection returns may appear on the radar display. These echoes appear in the same intervals, of which the nearest echo is the true echo of the target.

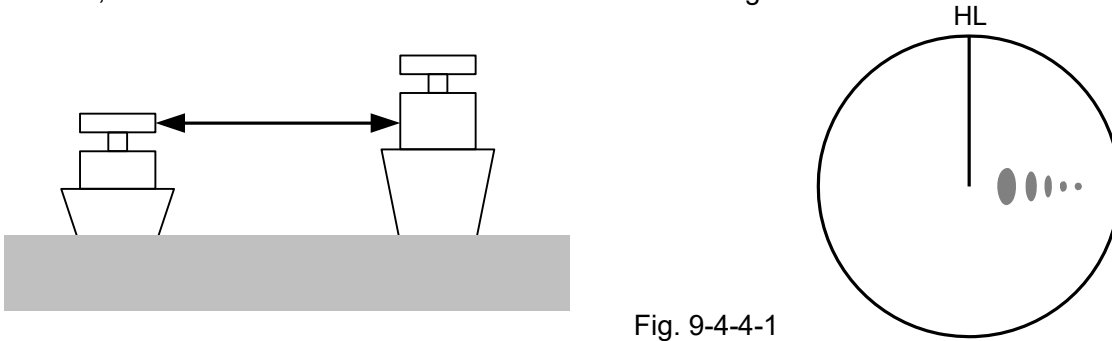

Fig. 9-4-4-1

### 9.4.5 SECOND TIME ECHOES

The maximum radar detection range depends upon the height of the scanner and the height of a target as described in the Section "9.1 RADAR WAVE WITH THE HORIZON". If a so-called "duct" occurs on the sea surface due to a certain weather condition, however, the radar beam may propagate to an abnormally long distance, at which a target may be detected by the radar.

For instance, assuming that the pulse length is MP3 (on the repetition frequency of 1400 Hz), the first pulse is reflected from a target at about 58 NM or more and received during the next pulse repetition time. In this case, a false echo (second time echo) appears at a position that is about 58 NM shorter than the actual distance. If the false echo appears at 5 NM on the radar display, the true distance of the target is  $5+58=63$  NM. On the pulse length is SP1 (on the repetition frequency of 2250 Hz), a false echo may appear at a position that is about 36 NM shorter than the actual distance.

This type of false echo can be discriminated by changing over the range scale (the repetition frequency), because the distance of the target changes accordingly.

If second time echo is appeared, the use of Economy mode in PRF menu is effective. Otherwise, Stagger Trigger menu set to on. (Refer to Section "8.4 SCANNER" of INSTALLATION MANUAL.)

### 9.4.6 RADAR INTERFERENCE

When another radar equipment using the same frequency band as that on own ship is near own ship, a radar interference pattern may appear on the radar display. This interference pattern consists of a number of spots which appear in various forms. In many cases, these spots do not always appear at the same places, so that they can be discriminated from the target echoes. (See Fig. 9-4-6-1)

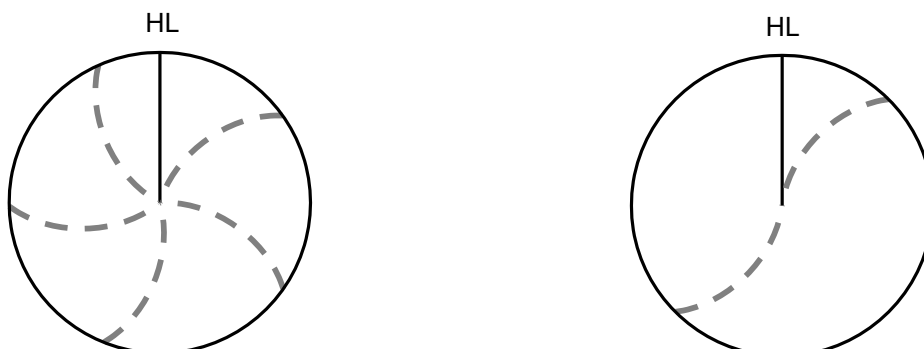

Fig. 9-4-6-1

If radar equipment causing an interference pattern and this radar are of the same model, their transmitting repetition frequency is nearly the same. As a result, interference patterns may be displayed concentrically.

In this case, the interference patterns cannot be eliminated by using only the interference reflector function, so press the [TX/PRF] key several times to fine-tune the transmitting repetition frequency. An interference suppressing effect can be heightened by applying a different transmitting repetition frequency to the interference pattern source radar and this radar.

## 9.5 DISPLAY OF RADAR TRANSPONDER(SART)

The SART (Search and rescue Radar Transponder) is a survival device authorized by the GMDSS (Global Maritime Distress and Safety System), which is used for locating survivors in case that a distress accident occurs at sea. The SART is designed to operate in the 9 GHz frequency band. When receiving the 9 GHz radar signal (interrogating signal) transmitted from the radar equipment on a rescue ship or search aircraft, the SART transmit a series of response signals to inform the distress position to the rescue and search party.

Perform the following settings to display SART on the radar screen.

- (1) Range : 6 NM or 12 NM
- (2) [SEA] control : Turning to the minimum position (counterclockwise fully)
- (3) Automatic sea clutter : Off (Set to manual sea clutter suppression.)  
suppression function
- (4) Tuning function : Off (for less clutter)
- (5) IR : Off
- (6) Processing : Off

### Note:





- When performing the settings (1) to (6) above to display the SART signal, targets around own ship will disappear from the radar display. Thus, it is necessary to exercise full surveillance over the conditions around own ship by visual watch in order to avoid any collision or stranding.

If two or more sets of radar equipment are installed on own ship, use one set of 9 GHz band radar for detection of the SART signal and operate others as normal radars for avoiding collision, monitoring targets around own ship, and checking on own ship's position and avoidance of stranding.

After the detection of SART signal, the radar adjustment is required for general navigation.

# Chapter 10 MAINTENANCE AND CHECK

## 10.1 ROUTINE MAINTENANCE

 <b>DANGER</b>	
	<p>Never carry out internal inspection or repair work of the equipment by users. Inspection or repair work by unauthorized personnel may result in fire hazard or electric shock.</p> <p>For inspection and repair work of equipment components, consult with our branch office, branch shop, sales office, or our distributor in your district.</p>
	<p>When conducting maintenance, make sure to turn the main power off. Failure to comply may result in electrocution.</p>
	<p>Turn off the main power before cleaning the equipment. Especially when a rectifier is used, make sure to turn it off since voltage is still outputted from the rectifier even after the indicator and the radar are turned off. Failure to comply may result in equipment failure, or death or serious injury due to electric shock.</p>

For operating the radar equipment in the good conditions, it is necessary to make the maintenance work as described below. If maintenance is made properly, troubles will reduce.

It is recommended to make regular maintenance work.

Common points of maintenance for each unit are as follow:





Clean the equipment.

Remove the dust, dirt, and sea water rest on the equipment cabinet with a piece of dry cloth. Especially, clean the air vents with a brush for good ventilation.



## 10.2 MAINTENANCE OF EACH UNIT

### 10.2.1 SCANNER UNIT NKE-2043, 2063A/AHS, 2103-4/4HS/6/6HS

 <b>DANGER</b>	
	<p><b>When conducting maintenance work on the antenna, make sure to turn its main power off.</b></p> <p><b>Failure to comply may result in electrocution or injuries.</b></p>
	<p><b>Make sure to turn off the antenna operation switch.</b></p> <p><b>Failure to comply may result in injuries caused by physical contact with the rotating antenna.</b></p>
	<p><b>Do not touch the radiator. Even if the power is turned off, the radiator may be rotated by the wind.</b></p>

After the work, turn "ON" the scanner unit safety switch.

#### ➤ Precautions in Mounting the Cover

When the cover is removed for regular checkup and replacement of parts and refitted after such work, the procedures of fastening bolts shall be taken with the following precautions:

#### [NKE-2043]

- The proper fastening torque of the fitting bolts (M5) is 102.96 N•cm (10.5kgf•cm) (which makes the inside water-tight and protects the packings against permanent compressive strain). Do not fasten the bolts with a torque exceeding the specified value. Otherwise, the screws may be broken.
- Use an 8mm wrench as a tool.
- Screw all the bolts by hand first to prevent them playing, then fasten them evenly in order not to cause one-sided fastening. (Fasten the bolts with 25% of the required torque at the first step.)

\*: Fasten the bolts in the diagonal order.

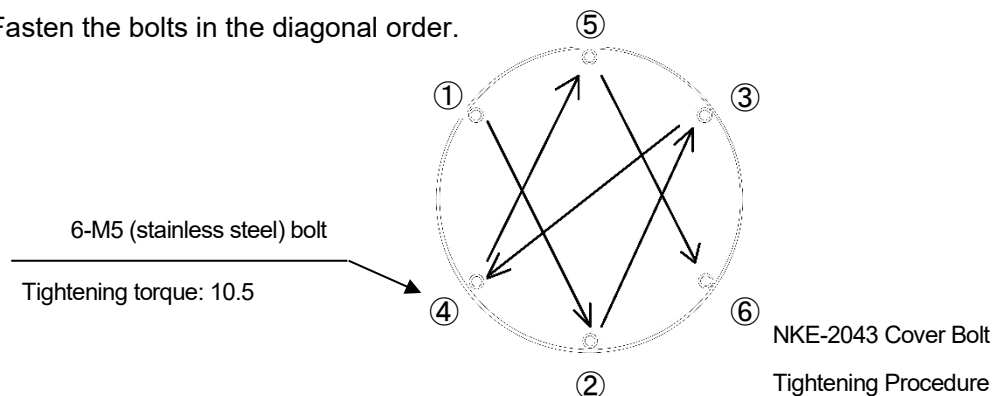

#### [NKE-2063A/AHS, NKE-2103-4/4HS/6/6HS]

- The proper fastening torque of the fitting bolts (M8) is 1176 to 1470 N•cm (120 to 150kgf•cm) (which makes the inside water-tight and protects the packings against permanent compressive strain). The packings start producing from the cover at a torque of approximately 1470N•cm (150kgf•cm). Do not fasten the bolts with a torque exceeding the specified value. Otherwise, the screws may be broken.
- Use an offset wrench of 11 mm × 13 mm or a double-ended wrench of 13 mm × 17 mm (not longer than 200 mm).
- Screw all the bolts by hand first to prevent them playing, then fasten them evenly in order not to cause one-sided fastening. (Fasten the bolts with 25% of the required torque at the first step.)

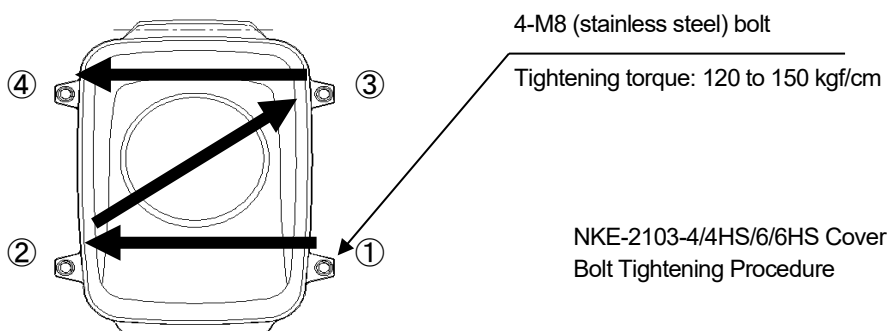
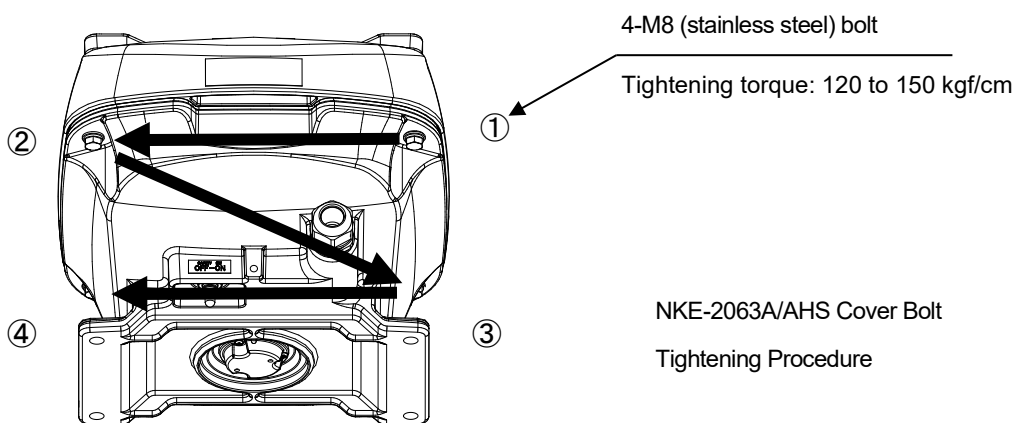

➤ Radiator

**Note:**

- If the radiator front face (radiation plane) is soiled with smoke, salt, dust, paint or birds' droppings, wipe it with a piece of soft cloth wetted with alcohol or water and try to keep it clean at all times. Otherwise, radar beam radiation may attenuate or reflect on it, resulting in deterioration of radar performance.
- Never use solvents of gasoline, benzine, trichloroethylene and ketone for cleaning.  
Otherwise, the radiation plane may deteriorate.

Check up and clean the radiator.

➤ Rotating section

- Oiling gears  
Apply grease evenly to the tooth surfaces of the main shaft drive gear and the encoder drive gear with a spreader or brush. Oiling in short intervals is more effective to prevent the gears from wear and tear and extend their service life, but oil at least every six months.

Use the grease of Mobilux 2 of Mobil Oil.

- Driving motor

1) Attenuator

Greasing is not necessary unless there is oil leakage.

2) Motor

The life span of the brush itself is 2000 hours. When the brush is worn out to a half of the entire length, replace it.

The communicator must be kept clean all the time. If carbon dust is stuck and cannot be removed with a dry cloth, polish the section with sand paper of No.150 to 400.

The carbon brush can be removed by removing the caps on both sides of the bottom of the motor.

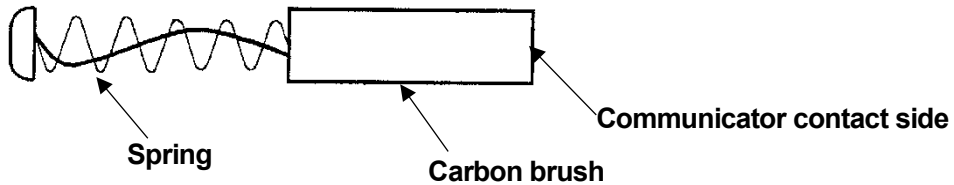

replacement carbon brushes

Scanner unit model name	Item name	Model name	JRC code
JMA-3406	Carbon brush	54531-01	BRXP05247

- Mounting legs

Check the mounting legs and mounting bolts of the scanner unit case for corrosion at intervals and maintain them to prevent danger. Apply paint to them once a half year because painting is the best measure against corrosion.

## 10.2.2 DISPLAY NCD-2364

<b>DANGER</b>	
	<b>When cleaning the display screen, do not wipe it too strongly with a dry cloth. Also, do not use gasoline or thinner to clean the screen. Failure to comply will result in damage to the screen surface.</b>

Dust accumulated on the screen will reduce clarity and darken the video.

For cleaning it, wipe it with a piece of soft cloth (flannel or cotton).

Do not wipe it strongly with a piece of dry cloth nor use gasoline or thinner.

## 10.3 PERFORMANCE CHECK

Make operational check on the radar equipment regularly and if any problem is found, investigate it immediately.

Pay special attention to the high voltage sections in checking and take full care that no trouble is caused by any error or carelessness in measurement. Please take note of the results of checking, the reason can be used effectively in the next check work.

Operational check shall be made in accordance with Table 10.3.1 Performance Check List in the order as specified in it.

<b>Equipment</b>	<b>Item to be checked</b>	<b>Criteria or Method</b>	<b>Remarks</b>
Scanner Unit	Tuning	Can be adjusted tuning at the manual tune. Observe a weak echo as far possible.	24NM or 48NM range during transmitting
	Magnetron Current	10.3.1 Test-System Information Scanner information The bar is 50% more	
	Antenna Rotation	Rotation speed can change slow, when small Range changing to up.	
Display Unit	Gain can be LCD brilliance can be Marker can be VRM can be EBL can be	Can be correctly controlled using the functional icon.	
	Communication Lines	10.3.8 Self Test Line Test	
	Key	10.3.8 Self Test Key Test	
	Key Light	10.3.8 Self Test Key Light Test	
	Buzzer	10.3.8 Self Test Buzzer Test	
	Memory	10.3.8 Self Test Memory Test	
	Error Logging check	10.3.1 Test-System Information Error Log	
	Software check	10.3.1 Test-System Information System Information	

**Table 10.3.1 Performance Check List**

### 10.3.1 TEST-SYSTEM INFORMATION

The performance status of this radar equipment can be checked on the Test Menu. Please run as needed.

- 1) Long press the MENU button.
- 2) Input 0 at Code Input screen, and press the ENT button.

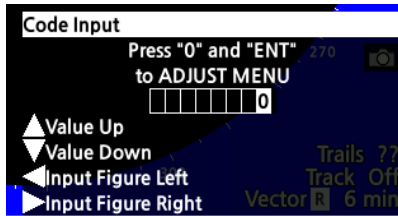

- 3) Select the Test-System Information at the Adjust Menu.

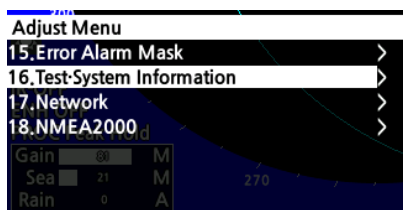

- 4) Select each item.

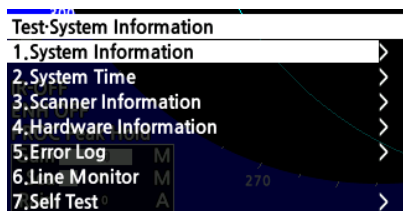

### 10.3.2 SYSTEM INFORMATION

Displays the current system information. (software version information).

- KERNEL
- DRIVER
- DISPLAY
- FPGA
- ARPA
- SCANNER
- RAMDISK

### 10.3.3 SYSTEM TIME

Displays the following system time information.

- Indicator Running Time
- Scanner Transmit Time
- Scanner Motor Running Time
- Scanner Running Time

### 10.3.4 SCANNER INFORMATION

Displays the following scanner information.

- Scanner Transmit Power
- Motor Type
- Magnetron Current

### 10.3.5 HARDWARE INFORMATION

Displays the following hardware information.

- Serial Number
- MAC Address
- Temperature
- Monitor Brilliance (no uint)

### 10.3.6 ERROR LOG

The error log displays previously occurred system alarms with the dates and times when they occurred.

The three alphabet of Condition column means follows,

ADD: Addition, Error added.

ACK: Acknowledge, you responded by pressing the “CLR” key.

REM: Remove Alarm, Error removed.

### 10.3.7 LINE MONITOR

Serial communication data can be seen on the built-in Line monitor.

Line monitor can be used to make sure that the serial data are received properly.

Line monitor controlling use the GAIN, SEA, RAIN and BRILL knob.

GAIN: Select NMEA port.

SEA: Select data display of ASCII or Binary. For example, NMEA data is ASCII, Scanner data iBinary.

RAIN: Start or Stop inputting data.

BRILL: Vanish the displayed data.

## 10.3.8 SELF TEST

The following tests can be performed.

- Key Test
- Buzzer Test
- Key Light Test
- Monitor Display Test
- Memory Test
- Line Test
- Scanner Test

### 10.3.8.1 KEY TEST

Performs the operation unit test.

The following screen is displayed, then operates the operation unit to check.

Press the CLR button twice to back to the Self Test menu.

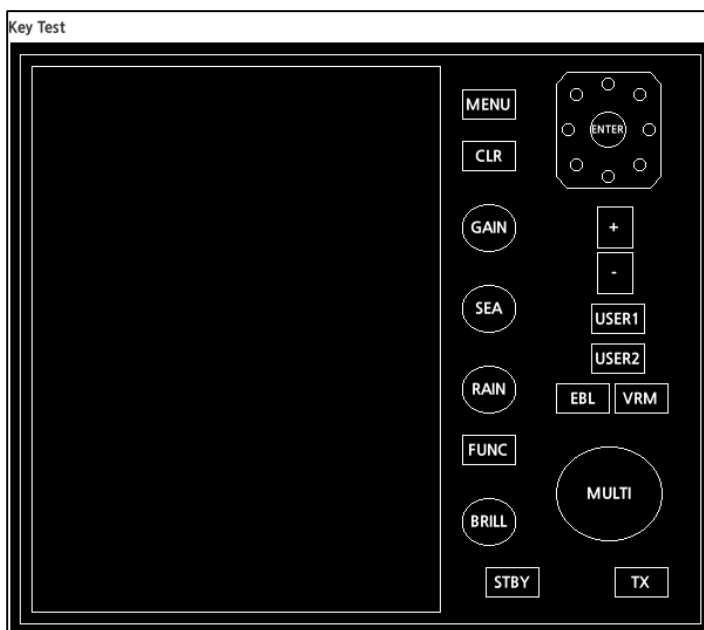

### 10.3.8.2 MONITOR DISPLAY TEST

Pattern 1 to 8 tests can be performed.

Pattern 8 can be displayed with specifying RGB values.

Pattern 1 to 7 are as follows.

Pattern 1 (White screen)

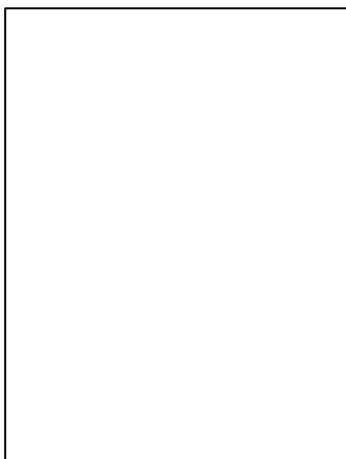

Pattern 2 (Black screen)

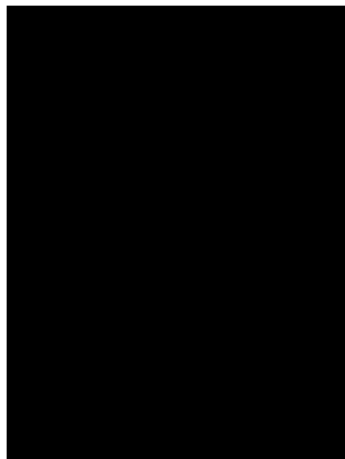

Pattern 3

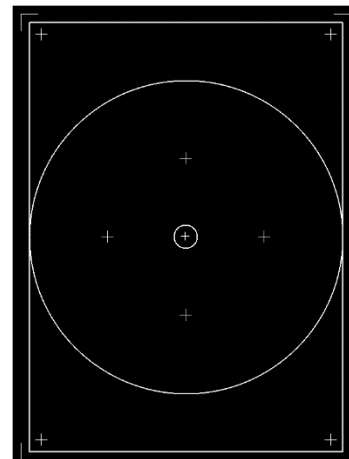

Pattern 4

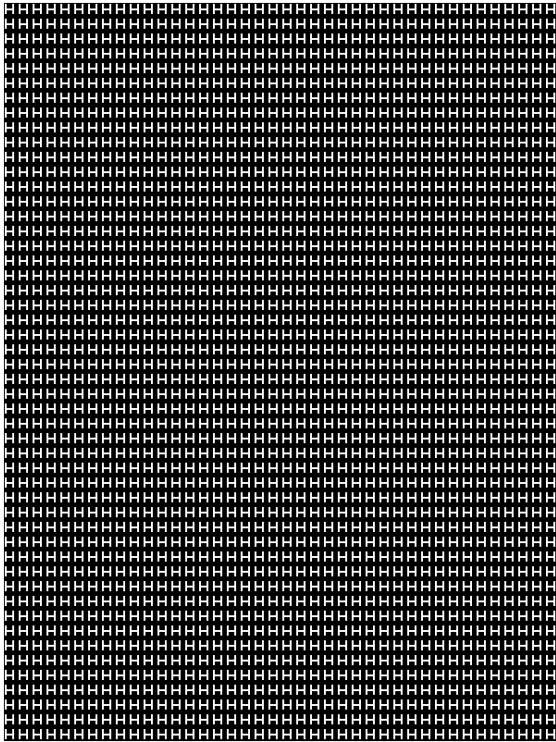

Pattern 5

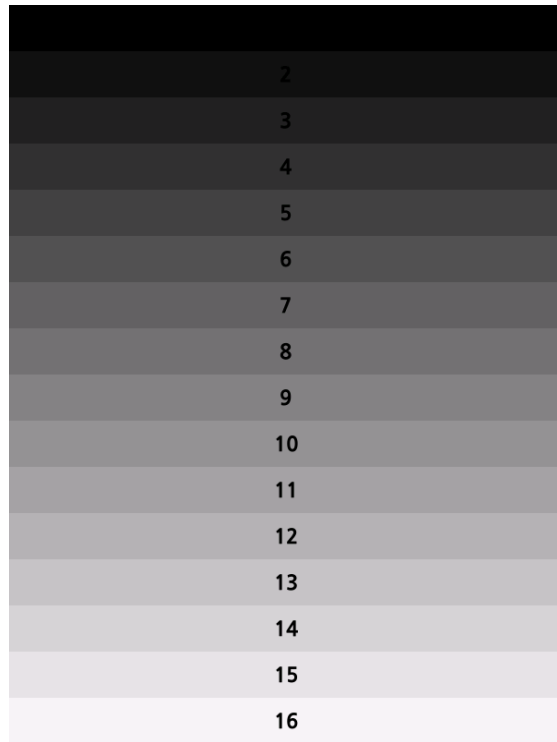

Pattern 6

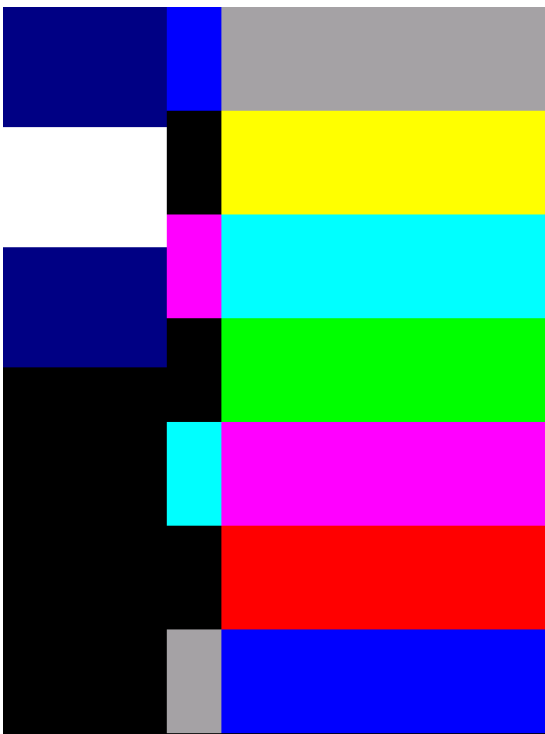

Pattern 7

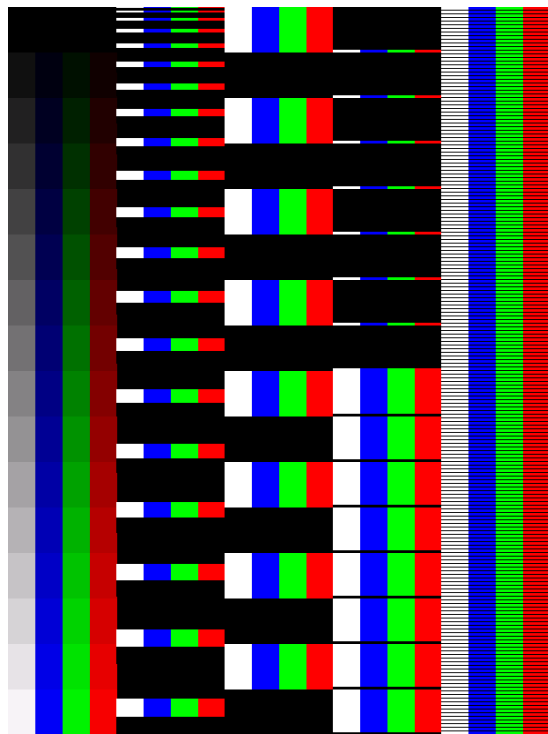



### 10.3.9 SOFTWARE UPDATE





Please refer to our Marine Service Department website (<http://msd.msweb.jp/>) for the document that describes the software update method and the update software.





## 10.4 REPLACEMENT OF MAJOR PARTS

The system includes parts that need periodic replacement. The parts should be replaced as scheduled. Use of parts over their service life can cause a system failure.

 <b>WARNING</b>	
	<b>Direct exposure to electromagnetic waves at close range will have adverse effects on the human body. When it is necessary to get close to the antenna for maintenance or inspection purposes, make sure to turn the indicator power switch to “OFF” or “STBY.”</b>
	<b>When conducting maintenance work, make sure to turn off the power and unplug the power connector J1 of the display unit so that the power supply to the equipment is completely cut off. Some equipment components can carry electrical current even after the power switch is turned off, and conducting maintenance work without unplugging the power connector may result in electrocution, equipment failure, or accidents.</b>

 <b>CAUTION</b>	
	<b>Make sure to shut off the main power before replacing parts. Failure to comply may result in electrocution or equipment failure.</b>
	<b>When replacing magnetrons, make sure to shut off the main power and let the equipment stand for more than 5 minutes to discharge the high-voltage circuit. Failure to comply may result in electrocution.</b>
	<b>Make sure to take off your watch when your hand must get close to the magnetron. Failure to comply may result in damage to the watch since the magnetron is a strong magnet.</b>
	<b>Since it will be high voltage temporarily remains in the circuit even after the main power is shut off. If you will touch the modulator, it should be touch after a few minutes for discharging of high voltage. Failure to comply may result in electrocution.</b>

## 10.4.1 PARTS REQUIRED FOR PERIODIC REPLACEMENT

 <b>DANGER</b>	
	<p>Never carry out internal inspection or repair work of the equipment by users. Inspection or repair work by unauthorized personnel may result in fire hazard or electric shock.</p> <p>For inspection and repair work of equipment components, consult with our branch office, branch shop, sales office, or our distributor in your district. It is also same periodic replacement parts.</p>

There are parts required for periodic replacement.

Parts Name	Interval
Magnetron	4,000 hours
Motor	10,000 hours
LCD Backlight <sup>※1</sup>	50,000 hours
Carbon brush (NKE-2063A)	2,000 hours

In many cases, parts required for periodic replacement works interval hours or more, but if it is over the interval hours it is recommended to replace the early.

### The occurrence of phenomenon when parts were consumed)

Magnetron: The radar sensitivity decreases, and it becomes difficult to take the tune.

Motor: Allophone generation and rotation instability or stop.

※1: Only LCD Backlight can not replace. The replacement is LCD module (CML-872).

 <b>CAUTION</b>	
	<p>Parts life time might become remarkably short by vibration of radar mast, surrounding environment and the weather more than product standard or mainly used radar range.</p>

## 10.5 FAULT FINDING

### 10.5.1 ALARMS AND OTHER DISPLAY LISTS

If any of the following alarm occurs, the system displays the alarm message in red in order to attract the attention of operator. Other messages are displayed with the suitable color which is yellow or blue depending on the level of message importance.

Alarm:	Red	– Collision-related Alarm
		– Navigation Alarm
		– System Alarm
Caution:	Yellow	– System Warning
Status:	Blue	– Operation Information

The following table shows alarms and other indications the system displays.

**Table 10.5.1 Alerts and other display lists**

Alarm Code *Screen notation	Alarm Name	Class	Description
S001	Alarm Error	Alarm	Cannot send the alarm because of insufficient message buffer for alarm task.
S002	Scanner(AZI)	Alarm	The BP error bit of scanner communication data is set.
S003	Scanner(HL)	Alarm	The BZ error bit of scanner communication data is set.
S004	Scanner(MHV)	Alarm	The high-voltage modulator error bit of scanner communication data is set.
S005	Scanner(Time out)	Alarm	No reply from the scanner after data communication.
S006	Scanner(Data)	Alarm	Collision occurs when transmitting data to the scanner. Checksum of the received data is different.
S007	Scanner(EEPROM)	Alarm	Stored value error is returned from the scanner when the initial adjustment data is requested. The save operation is not completed when data save is requested to scanner EEPROM.
S008	Scanner(Heater)	Alarm	The MAG heater voltage error bit of scanner communication data is set.
S009	Scanner(Reverse)	Alarm	The Scanner reverse bit of scanner communication data is set.
S010	Scanner(Video)	Alarm	The VIDEO error bit of scanner communication data is set.
S011	Scanner(Triple)	Alarm	The TRIGGER error bit of scanner communication data is set.
S012	Scanner(Safety-SW Off)	Alarm	The SAFETY SWITCH OFF bit of scanner communication data is set.
D001	GPS Port	Alarm	Serial driver error occurs.
D002	NMEA1 Port	Alarm	Serial driver error occurs.
D003	NMEA2 Port	Alarm	Serial driver error occurs.
D004	NMEA3 Port	Alarm	Serial driver error occurs.
D005	Scanner Port	Alarm	Serial driver error occurs.

Alarm Code *Screen notation	Alarm Name	Class	Description
D006	Keyboard	Alarm	Serial driver error occurs.
D007	GYRO(Time Out)	Alarm	For heading equipment=GYRO, cannot receive valid sentences (including checksum error) which had been received properly.
D008	Log(Time Out)	Alarm	For speed equipment=log, cannot receive valid sentences (including checksum error) which had been received properly.
D009	GYRO(Data)	Alarm	For heading equipment=GYRO, the GYRO error bit of NSK communication data is set.
D010	Log(Data)	Alarm	For speed equipment=log, the LOG error bit of NSK communication data is set.
D011	Heading(Time Out)	Alarm	For heading equipment=compass, cannot receive valid NMEA bearing sentences (including checksum error) which had been received properly.
D012	Heading(Data)	Alarm	For heading equipment=compass, cannot receive valid NMEA bearing data which had been received properly.
D013	2AXG(Time Out)	Alarm	For speed equipment =2-axis log, cannot receive valid VBW sentences(including checksum error) which had been received properly.
D014	2AXG(Data)	Alarm	For speed equipment=2-axis log, cannot receive valid VBW ground data which had been received properly.
D015	GPS(Time Out)	Alarm	Cannot receive valid GPS sentences(including checksum error) which had been received properly.
D016	GPS(Position)	Alarm	Cannot receive valid position data which had been received properly.
D017	GPS(Datum)	Alarm	Cannot receive valid geodetic data which had been received properly.
D018	GPS(Speed)	Alarm	For Speed equipment=GPS, cannot receive valid speed data which had been received properly.
D019	GPS(Status)	Alarm	Received GPS fixing status error (invalid) data
D020	Depth(Time Out)	Alarm	Cannot receive valid depth sentences (including checksum error) which had been received properly.
D021	Depth(Data)	Alarm	Cannot receive valid depth data which had been received properly.
D022	TEMP(Time Out)	Alarm	Cannot receive valid water temperature sentences which had been received properly.
D023	TEMP(Data)	Alarm	Cannot receive valid water temperature data which had been received properly.
D024	Wind(Time Out)	Alarm	Cannot receive valid wind direction/wind velocity sentences (including checksum error) which had been received properly.
D025	Wind True(Data)	Alarm	Cannot receive valid wind direction/wind velocity (true) data had been received properly.
D026	Wind Relative(Data)	Alarm	Cannot receive valid wind direction/wind velocity (relative) data had been received properly.

Alarm Code *Screen notation	Alarm Name	Class	Description
D027	Turn(Time Out)	Alarm	Cannot receive valid turning ratio sentences (including checksum error) which had been received properly.
D028	Turn(Data)	Alarm	Cannot receive valid turning ratio data which had been received properly.
D029	Rudder(Time Out)	Alarm	Cannot receive valid steering direction sentences (including checksum error) which had been received properly.
D030	Rudder(Data)	Alarm	Cannot receive valid steering direction data which had been received properly
D031	AIS(Time Out)	Alarm	For AIS function=ON, cannot receive valid AIS data (including checksum error) which had been received properly.
D032	AIS(Data)	Alarm	For AIS function=ON, cannot receive valid AIS data which had been received properly.
D033	AIS(Alarm001)	Alarm	For AIS function=ON, an error from the AIS receiver is received(ALR).
D034	AIS(Alarm002)	Alarm	For AIS function=ON, an error from the AIS receiver is received(ALR).
D035	AIS(Alarm003)	Alarm	For AIS function=ON, an error from the AIS receiver is received(ALR).
D036	AIS(Alarm004)	Alarm	For AIS function=ON, an error from the AIS receiver is received(ALR).
D037	AIS(Alarm005)	Alarm	For AIS function=ON, an error from the AIS receiver is received(ALR).
D038	AIS(Alarm006)	Alarm	For AIS function=ON, an error from the AIS receiver is received(ALR).
D039	AIS(Alarm008)	Alarm	For AIS function=ON, an error from the AIS receiver is received(ALR).
D040	AIS(Alarm025)	Alarm	For AIS function=ON, an error from the AIS receiver is received(ALR).
D041	AIS(Alarm026)	Alarm	For AIS function=ON, an error from the AIS receiver is received(ALR).
D042	AIS(Alarm029)	Alarm	For AIS function=ON, an error from the AIS receiver is received(ALR).
D043	AIS(Alarm030)	Alarm	For AIS function=ON, an error from the AIS receiver is received(ALR).
D044	AIS(Alarm032)	Alarm	For AIS function=ON, an error from the AIS receiver is received(ALR).
D045	AIS(Alarm035)	Alarm	For AIS function=ON, an error from the AIS receiver is received(ALR).
D046	Set Gyro	Status	Requires setting of true bearing.
D047	DSP(Video)	Alarm	DSP detects VIDEO error.
D048	DSP(Triigger)	Alarm	DSP cannot receive TI interrupt.
D049	DSP(AZI)	Alarm	DSP cannot receive BP interrupt.
D050	DSP(HL)	Alarm	DSP cannot receive BZ interrupt.
D051	DSP Error	Alarm	Abnormal operation(infinite loop) of DSP.

Alarm Code *Screen notation	Alarm Name	Class	Description
D052	LAT(Out of Bounds)	Caution	The own ship's latitude is 80 degrees or more (indicating that some functions are limited). Display AIS, waypoint, mark/line, own ship trail, etc. for 80 degrees or more. Input operations for 80 degrees or more ( refer to "High Latitude "alarm)
D053	TT(Out of Range)	Alarm	TT is too far to be tracked.
D055	Flash ROM Error	Alarm	Initialization error of flash ROM file system during startup.
D056	USB Error	Alarm	Initialization error of USB during startup.
D057	SD Error	Alarm	Chart SD card reading error.

Alarm Name *Screen notation	Class	Description
Area1(Approach)	Alarm	Echo in area1.
Area1(Secession)	Alarm	No echo in area1.
Area1(Out of Range)	Alarm	Rectangle area 1 is out of range. Creation of area 1 is out of range.
Area2(Approach)	Alarm	Echo in area2.
Area2(Secession)	Alarm	No echo in area2.
Area2(Out of Range)	Alarm	Rectangle area 2 is out of range. Creation of area 2 is out of range.
TT(CPA/TCPA)	Alarm	TT is changed to a dangerous ship
TT(New Target)	Alarm	TT is automatically acquired.
TT(Lost)	Alarm	TT is lost.
Dragging anchor	Alarm	The ship has left the dragging anchor monitoring area.
GPS(Error)	Status	Failed to set GPS.
GPS(HDOP)	Caution	Received excessive HDOP value beyond the setting.
TM Reset	Status	For TM, the own ship position is out of 40% of the radius of PPI.
No Heading Data	Status	Cannot function because own ship heading is not available <ul style="list-style-type: none"> <li>- Operations for specifying TT acquisition/numerical display</li> <li>- Changing to TM</li> <li>- Changing to N Up/C Up</li> </ul>
On Preheating	Status	Transmission operation during preheating
Short Interval	Status	Transmission operation in the interval of 1 second or less between standby and transmission
Error Occurring	Status	Transmission operation during prohibition of transmission caused by scanner error
Max Point	Status	Exceeded the maximum number of marks.
File Not Found	Status	File does not exist.
USB Memory Not Set	Status	USB memory does not exist.
SD Memory Not Set	Status	SD memory does not exist.
File Read Error	Caution	Failed to load the file.
File Write Error	Caution	Failed to write the file.
Not Enough Space	Status	Insufficient capacity.
Format Error	Caution	Failed to format.
Num of files Over	Caution	Writing data to the USB memory in which the number of the file has reached to the maximum.
File Erase Error	Caution	Failed to delete the file.
TT(Max Target)	Status	Manually acquired when the number of acquisitions reached maximum. Detected when DSP tries to acquire 11 targets or more. DSP notifies the maximum target alarm occurrence of automatic acquisition to the TT process task, then the TT process task notifies it to the alarm task.
Unsetting	Status	Zone creation operations for guard zone = Off. EBL bearing setting while EBL is off. Floating setting while EBL/VRM is off. VRM range setting while VRM is off. Manual tuning setting while automatic tuning is on. AIS operations while AIS function is off. TT operations while TT function is off.

Alarm Name *Screen notation	Class	Description
Invalid Data	Status	Cannot function due to invalid value - Invalid code is input for the code input screen
In Operation	Status	This operation is disabled due to another operation - Setting enable/disable and level during guard zone creation - Operations for on/off during VRM range setting - Operations for PRF tuning during manual tuning operations - Setting for automatic/manual mode during manual tuning Operations - Operations for manual tuning during PRF tuning operation
No HDG/POSN Data	Status	Cursor operations when own heading or latitude/longitude is disabled - MOB input - Event mark input - Inputting/erasing/moving marks - Inputting/erasing/moving/inserting lines - AIS numerical display/destination ship/retrieved vessel Selection - Creating latitude/longitude guard zone. - TLL transmission for cursor.
Not Allowed	Status	Operations for inserting by selecting the end point in the line list. Operations for switching to H-UP during TM (When heading is not available, temporarily changed to RM H-Up, therefore, message is disabled.)
Range Scale Limit	Status	Operations functionally restricted for certain range. Off center operations in range where off center is not available. TM setting operations in range where TM setting is not available.
No Valid Data	Status	Operations without data.
Scanner Standby	Status	The functions which are available only during transmitting are operated during standby (or preheating). - Setting Timed TX to on. - Cursor operations during standby (no graphic display is available). - Custom position setting for off center. - Inputting/erasing/moving marks - Inputting/erasing/moving/inserting lines - TT acquisition/release/numerical display selection. - Guard zone creation
High Temperature	Caution	The temperature in the radar antenna is 80 °C or higher.
High Latitude	Status	Operations for the position of latitude 80 degrees or more. - MOB input. - Event mark input. - Input/moving marks. - Input/moving/inserting lines.



Alarm Name *Screen notation	Class	Description
		- Creating latitude/longitude alarm area.
Invalid Version	Status	Program is loading a file with an incompatible version. - Internal setting - Marks/lines - Option languages - STC curve
TT(Max Target)	Status	Detects when trying to automatically capture the 31st or more targets.
TT(Out of Range)	Status	TT is too far to be tracked.
MAX Range Scale	Status	Range up operations at the maximum range.
MIN Range Scale	Status	Range down operations at the minimum range.
In preparing	Status	Ready state after USB memory or SD card is inserted until it can be used.
Writing	Status	Writing data to USB memory.
Loading	Status	Loading data from the USB memory.
Link down	Alarm	After a successful LAN connection, communication is interrupted and a timeout of 10 seconds or more.
Sweep Echo Failure	Alarm	After the Radar echo delivering stop in transmitting condition, and the timeout exceeds 10 seconds.

## 10.6 TROUBLE SHOOTING

As this radar equipment includes complicated circuits, it is necessary to request a specialist engineer for repair or instructions for remedy if any circuit is defective.

There are also troubles by the following causes, which should be referred to in checking or repair work.

- Poor Contact in Terminal Board of Inter-Unit Cables.
- Poor contact in terminal board.
- The cable end is not fully connected, that it, contacted with earthed another terminal.
- Disconnected cable wire.
- Poor Contact of Connector with in Unit.

### 10.6.1 SPECIAL PARTS

#### JMA-3404

Location	Parts No.	Name	Type	Code	Manufacture
Scanner	V101	Magnetron	MSF1421B	5VMAA00092	NJRC
Scanner	A101	Circulator	FCX68R	5AJIX00027	Orient Microwave
Scanner	A102	Diode Limiter	NJS6930	5ATBT00006	NJRC

#### JMA-3406/HS

Location	Parts No.	Name	Type	Code	Manufacture
Scanner	V101	Magnetron	MSF1422B	5VMAA00090	NJRC
Scanner	A101	Circulator	FCX68R	5AJIX00027	Orient Microwave
Scanner	A102	Diode Limiter	NJS6930	5ATBT00006	NJRC

**JMA-3411-4/4HS/6/6HS**

<b>Location</b>	<b>Parts No.</b>	<b>Name</b>	<b>Type</b>	<b>Code</b>	<b>Manufacture</b>
Scanner	V101	Magnetron	MAF1565N	5VMAA00102	NJRC
Scanner	A101/ A102	Circulator	FCX68R	5AJIX00027	Orient Microwave
Scanner	A103	Dummy	NJC4002	5ANDF00001	NJRC
Scanner	A104	Filter	NJC9952	5AWAX00002	NJRC
Scanner	A301	Diode Limiter	NJS6930	5ATBT00006	NJRC

## 10.6.2 CIRCUIT BLOCK TO BE REPAIRED

### JMA-3404

Location	Circuit Block	Type	Remarks
Scanner	Motor unit	7BDRD0052*	
Scanner	Compound Modulator Circuit	CME-385	
Scanner	Receiver	NRG-239	Include CAE-548
Display Unit	Processing circuit	CDC-1497	
Display Unit	TT circuit	CDC-1498	
Display Unit	Keyboard circuit	CCK-1141	
Display Unit	USB/SD I/F circuit	CMH-2515	
Display Unit	Power supply circuit	CBD-2028	
Display Unit	I/F circuit	CMH-2512	
Display Unit	Scanner I/F circuit	CMH-2513	
Display Unit	Power supply I/F circuit	CMH-2514	
Display Unit	LCD module	CML-872	
Display Unit	Fuse	MF60NR 250V 10	F1

\*\*\* means revision, such as A, B and so on.

### JMA3406/HS

Location	Circuit Block	Type	Remarks
Scanner	Motor unit	CBP-218	
Scanner	Compound Modulator Circuit	CME-386A	
Scanner	Receiver	NRG-239	Include CAE-548
Display Unit	Processing circuit	CDC-1497	
Display Unit	TT circuit	CDC-1498	
Display Unit	Keyboard circuit	CCK-1141	
Display Unit	USB/SD I/F circuit	CMH-2515	
Display Unit	Power supply circuit	CBD-2028	
Display Unit	I/F circuit	CMH-2512	
Display Unit	Scanner I/F circuit	CMH-2513	
Display Unit	Power supply I/F circuit	CMH-2514	
Display Unit	LCD module	CML-872	
Display Unit	Fuse	MF60NR 250V 10	F1

## JMA-3411-4/4HS/6/6HS

Location	Circuit Block	Type	Remarks
Scanner	Motor with gear	7BDRD0048*	DC brushless motor
Scanner	Modulation circuit	CME-363A	Excluding Magnetron
Scanner	Receiver	NRG-610A	Include CAE-529A-1
Scanner	Power supply circuit	CBD-2783	
Scanner	Encoder	CHT-71C	
Scanner	Motor control power	CBD-1779	
Display Unit	Processing circuit	CDC-1497	
Display Unit	TT circuit	CDC-1498	
Display Unit	Keyboard circuit	CCK-1141	
Display Unit	USB/SD I/F circuit	CMH-2515	
Display Unit	Power supply circuit	CBD-2028	
Display Unit	I/F circuit	CMH-2512	
Display Unit	Scanner I/F circuit	CMH-2513	
Display Unit	Power supply I/F circuit	CMH-2514	
Display Unit	LCD module	CML-872	
Display Unit	Fuse	MF60NR 250V 10	F1

\*\*\* means revision, such as A, B and so on.

# Chapter 11 AFTER-SALE SERVICE

## 11.1 KEEPING PERIOD OF MAINTENANCE PARTS

Keeping period of maintenance parts is ten years from the production is discontinued.

## 11.2 WHEN YOU REQUEST FOR REPAIR

If you suppose the product may be out of order, read the description in "10.5 FAULT FINDING" and "10.6 TROUBLE SHOOTING", and check the suspected point again.

If it is still out of order, you are recommended to stop operation of the equipment and consult with the dealer from whom you purchased the product, or our branch office in your country or district, the sales department in our main office in Tokyo.

- Repair within the Warranty Period  
If any failure occurs in the product during its normal operation in accordance with the instruction manual, the dealer or JRC will repair free of charge.  
In case that any failure is caused due to misuse, faulty operation, negligence or force major such as natural disaster and fire, the product will be repaired with charges.
- Repair after the Warranty Period.  
If any defective function of the product is recoverable by repair, the repair of it will be made at your own charge upon your request.
- Necessary Information for Repair
  - ☆ Product name, model, manufacturing date and serial number
  - ☆ Trouble conditions (as detailed as possible. Refer to page "11.4 RADAR FAILURE CHECK LIST.")
  - ☆ Name of company/organization, address and telephone number

## 11.3 RECOMMENDED MAINTENANCE

The performance of the product may deteriorate due to the secular change of the parts used in it, though such deterioration depends upon the conditions of operation.

Hence, checkup and maintenance are recommendable for the product in addition to your daily care.

For maintenance, consult with the near-by dealer or our sales department.

Such maintenance will be made with charges.

For further details of after-sale service, contact the JRC Offices.

## 11.4 RADAR FAILURE CHECK LIST

### ■ Radar Failure Check List

#### Radar Failure Check List

When placing an order for repair of the product, it is requested that you could confirm the check items and fill the results and sent the sheet to our contact.

If there is any unclear items, contact the ship on which the product is installed, and give the correct information on the product.

Ship name: \_\_\_\_\_ Phone: \_\_\_\_\_ Fax: \_\_\_\_\_

Radar general model name: JMA- \_\_\_\_\_ Serial No. : \_\_\_\_\_

(Write the full model name correctly)

(1) Check the following items in the order of the number, and circle the applicable answer between YES or NO. If the item cannot be determined as YES or NO, explain in detail in the item (17), others.

(2) If any of the items (1) to (5) is marked as NO, check the fuse of the product (refer to Section 9.1.2 and 9.2).

(3) Check the items (4) to (16) while the transmission (TX) is ON.

\*Functions mentioned in the items (14), (15) and (16) may be optional, answer is not necessary.

No.	Check Item	Result	
		YES	NO
(1)	Power can be turned on. (The lamp on the Operation unit is lit)	YES	NO
(2)	A few minutes after powering-on, it will become standby status .	YES	NO
(3)	When powering-on (or TX ON), LCD monitor something is lit.	YES	NO
(4)	The antenna rotates at the transmission (TX) ON. (Check the following items while transmission is ON)	YES	NO
(5)	Current is supplied to the magnetron. (Refer to the instruction manual)	YES	NO
(6)	Turning is enabled. (Check with the range of 6 NM or more)	YES	NO
(7)	Fixed marker is displayed.	YES	NO
(8)	VRM is displayed.	YES	NO
(9)	While noise is displayed while set at SEA and RAIN minimum, GAIN maximum, IR-OFF and range 48 NM.	YES	NO
(10)	Target reflection echo is displayed.	YES	NO
(11)	Sensitivity of reflection echo is normal.	YES	NO
(12)	EBL is displayed.	YES	NO
(13)	Cursor mark moves.	YES	NO
*(14)	Position and compass information can be normally displayed	YES	NO
*(15)	LOG speed can be normally displayed.	YES	NO
*(16)	Target tracking function works normally.	YES	NO

(17) Others (Error message, etc. ) \_\_\_\_\_

\_\_\_\_\_

\_\_\_\_\_

\_\_\_\_\_

\_\_\_\_\_

# Chapter 12 DISPOSAL

## 12.1 DISPOSAL OF THE UNIT

When disposing of this unit, be sure to follow the local laws and regulations for the place of disposal.

## 12.2 DISPOSAL OF USED MAGNETRON

A magnetron is used for the scanner (NKE-2043, NKE-2063A/AHS, NKE-2103-4/4HS and NKE-2103-6/6HS).

☆ When the magnetron is replaced with a new one, return the used magnetron to our dealer or business office.

For detail, consult with our dealer or business office.

## 12.3 CHINA ROHS

有毒有害物质或元素的名称及含量  
(Names & Content of toxic and hazardous substances or elements)

形式名(Type): JMA-3400 Series

名称(Name): RADAR

部件名称 (Part name)	有毒有害物质或元素 (Toxic and Hazardous Substances and Elements)					
	铅 (Pb)	汞 (Hg)	镉 (Cd)	六价铬 (Cr6+)	多溴联苯 (PBB)	多溴二苯醚 (PBDE)
雷达天线单元 (Scanner Unit)	×	×	○	×	×	×
收发信单元 (Transmitter-receiver Unit)	×	×	×	×	×	×
主船内装置 (Inboard Unit) · 显示装置 (Display Unit) · 键盘装置 (Operation Unit) · 信号处理装置 (RADAR Process Unit)	×	×	×	×	×	×
外部设备 (Peripherals) · 选择 (Options) · 电线类 (Cables) · 手册 (Documents)	×	×	×	×	×	×
<p>○: 表示该有毒有害物质在该部件所有均质材料中的含量均在SJ/T11306-2006 标准规定的限量要求以下。 (Indicates that this toxic, or hazardous substance contained in all of the homogeneous materials for this part is below the requirement in SJ/T11363-2006.)</p> <p>×: 表示该有毒有害物质至少在该部件的某一均质材料中的含量超出SJ/T11363-2006 标准规定的限量要求。 (Indicates that this toxic or hazardous substance contained in at least one of the homogeneous materials used for this part is above the limit requirement in SJ/T 11363-2006.)</p>						

# Chapter 13 SPECIFICATIONS



**NKE-2043**



**NKE-2063A/AHS**



**NKE-2103-4/4HS**



**NNKE-2103-6/6HS**



## JMA-3400 Series





# 13.1.2 NKE-2063A/AHS

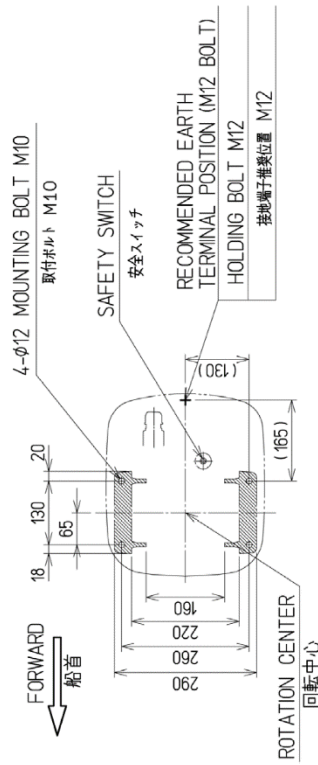

MOUNTING DIMENSIONS (TOP VIEW)  
取付寸法図 (上面視)

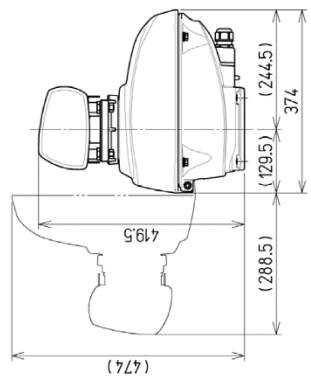
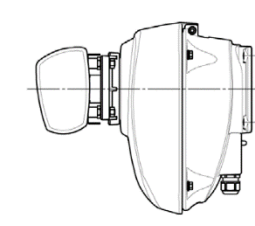
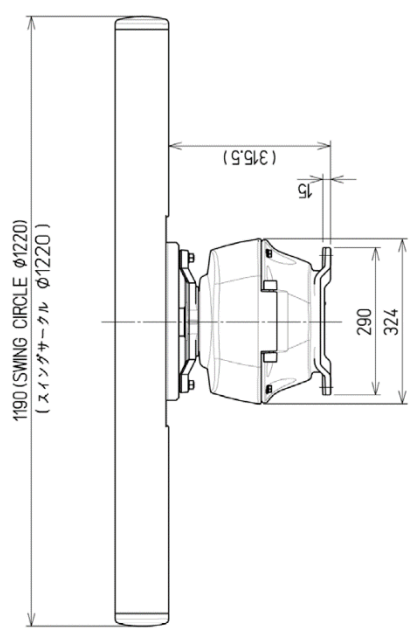
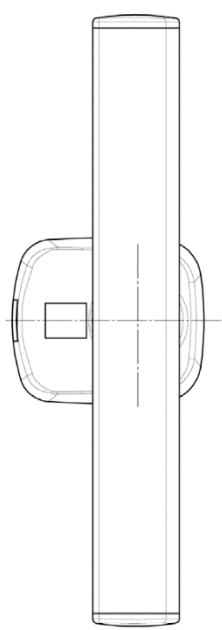

OUTLINE DIMENSIONS		PERMISSIBLE MOUNTING DIMENSIONAL DEVIATIONS	PERMISSIBLE OUTLINE DIMENSIONAL DEVIATIONS
OVER	TO		
3	6	±0.5	
6	30	±1	±0.5
30	120	±1.5	
120	400	±2.5	±1
400	1000	±4	±2
1000	2000	±6	
2000	4000	±8	±3

外形寸法		外形寸法 許容差	取付寸法 許容差
を越え	以下		
3	6	±0.5	
6	30	±1	±0.5
30	120	±1.5	
120	400	±2.5	±1
400	1000	±4	±2
1000	2000	±6	
2000	4000	±8	±3

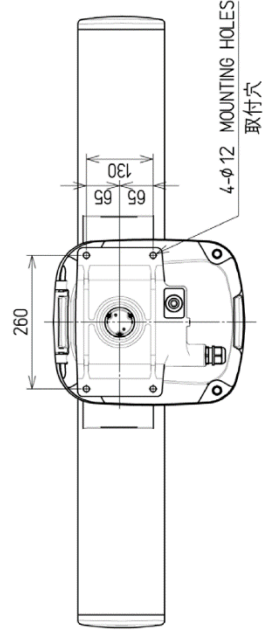

MASS	APPROX. 21 kg
UNIT	mm
COLOR	ANTENNA WHITE
COLOR	PEDESTAL WHITE
質量	約 21 kg
単位	mm
色	輻射部 白
色	ペDESTアル 白

### 13.1.3 NKE-2103-4/4HS

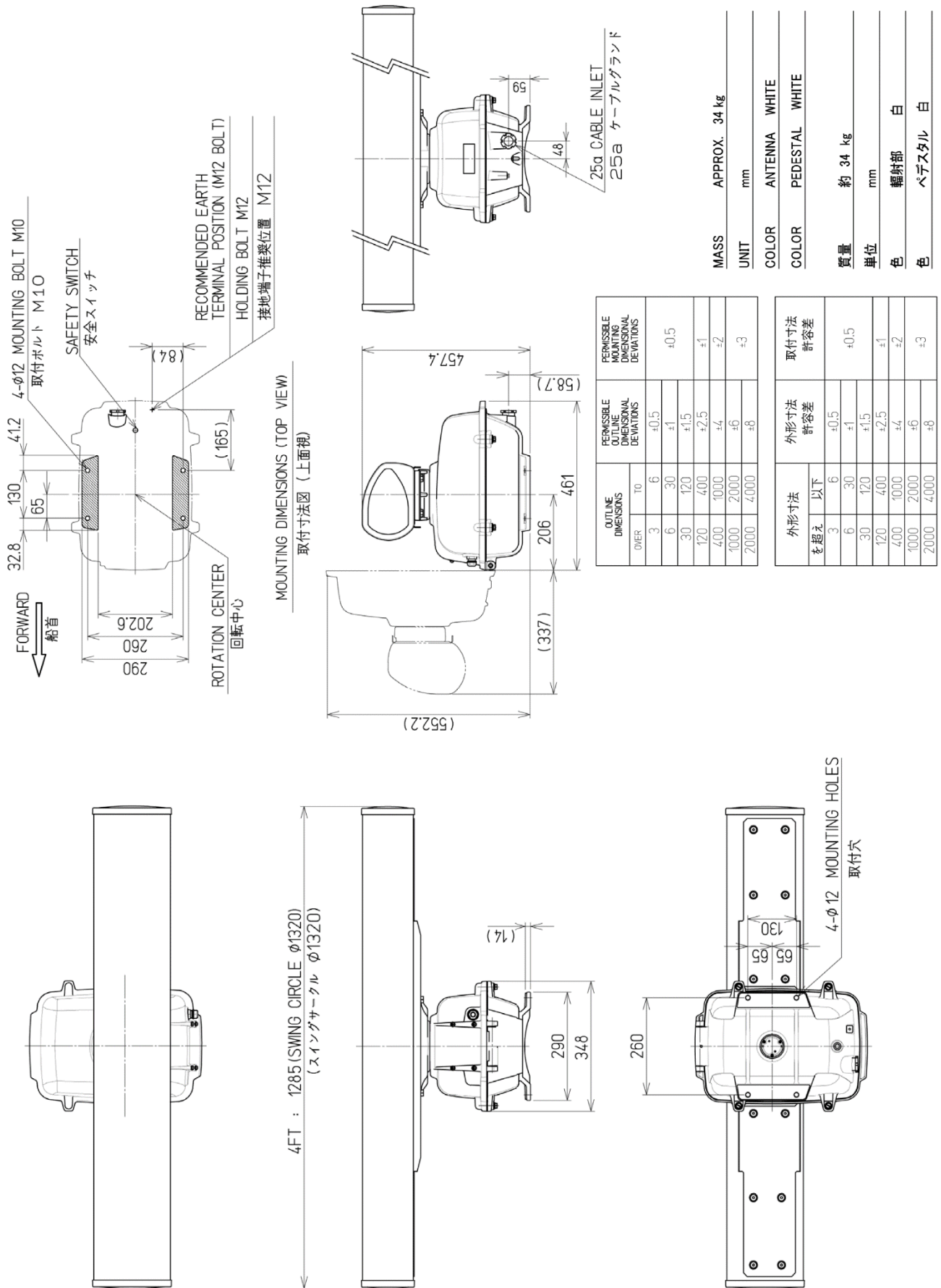

# 13.1.4 NKE-2103-6/6HS

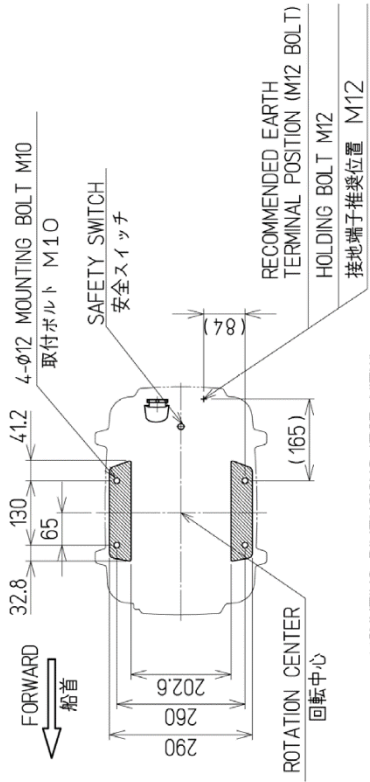

MOUNTING DIMENSIONS (TOP VIEW)  
取付寸法図 (上面視)

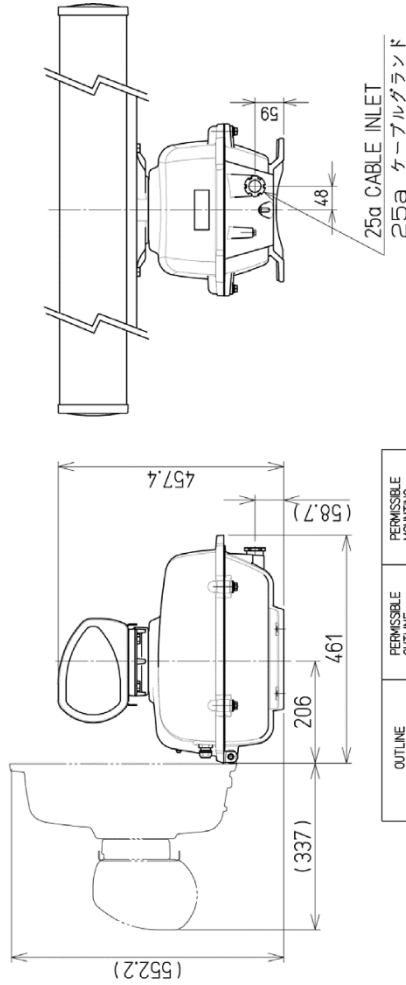

OUTLINE DIMENSIONS		PERMISSIBLE DIMENSIONAL DEVIATIONS	PERMISSIBLE DIMENSIONAL DEVIATIONS
OVER	TO		
3	6	+0.5	+0.5
6	30	±1	
30	120	±1.5	±1
120	400	±2.5	
400	1000	±4	±2
1000	2000	±6	
2000	4000	±8	±3

外形寸法		外形寸法 許容差	取付寸法 許容差
を 超え	以下		
3	6	+0.5	±0.5
6	30	±1	
30	120	±1.5	±1
120	400	±2.5	
400	1000	±4	±2
1000	2000	±6	
2000	4000	±8	±3

MASS APPROX. 36 kg  
UNIT mm  
COLOR ANTENNA WHITE  
COLOR PEDESTAL WHITE

質量 約 36 kg  
単位 mm  
色 輻射部 白  
色 ペDESTAL 白

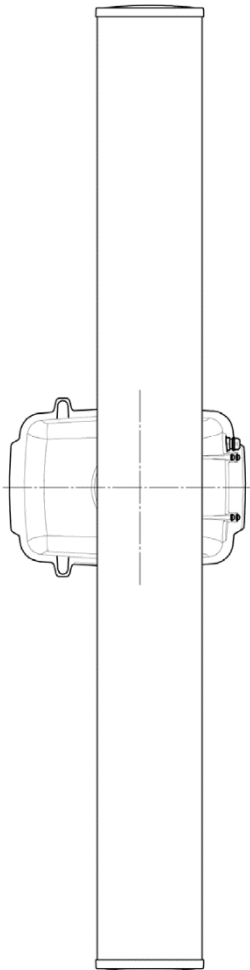

6FT : 1880 (SWING CIRCLE φ1910)  
(スイングサークル φ1910)

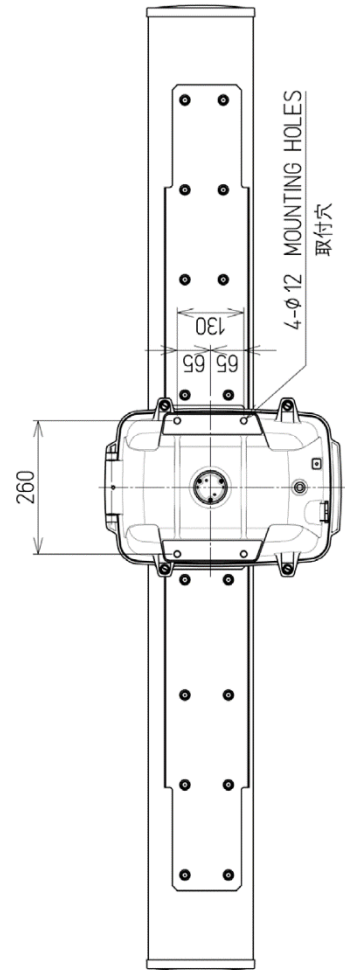
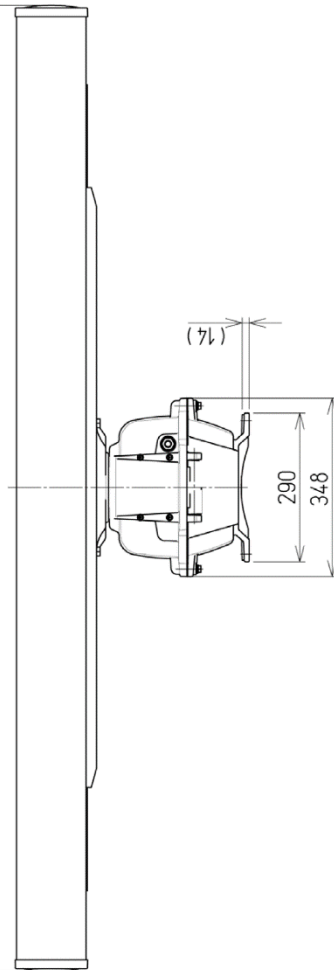

# 13.2 DISPLAY DIMENSION

## 13.2.1 NCD-2364

外形寸法 DIMENSIONS を基に OVER	外形寸法 許容差 PERMISSIBLE DIMENSIONAL DEVIATIONS	取付方法 許容差 PERMISSIBLE DIMENSIONAL DEVIATIONS
3	±0.5	
6	±1	±0.5
30	±1.5	
120	±2.5	±1
400	±4	±2

総合銘板  
MODEL NAME PLATE  
指示機銘板  
UNIT NAME PLATE

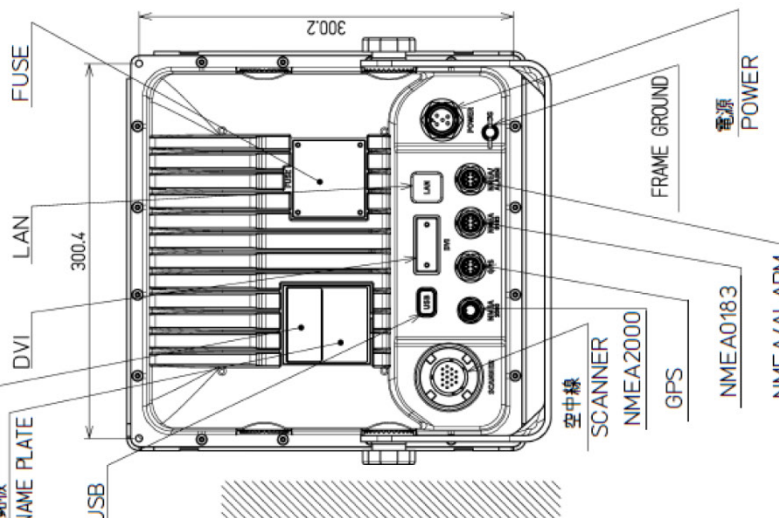
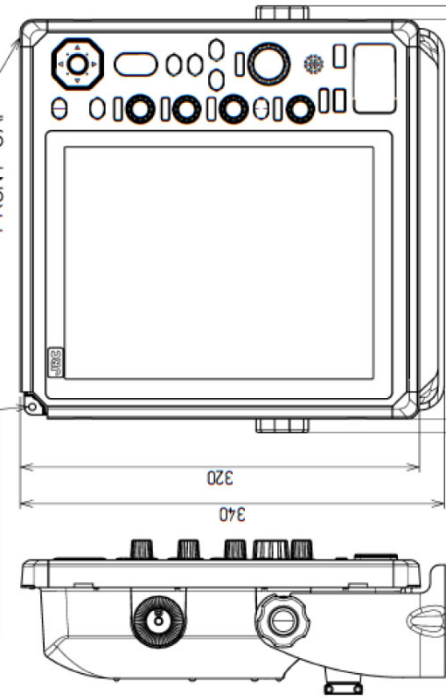
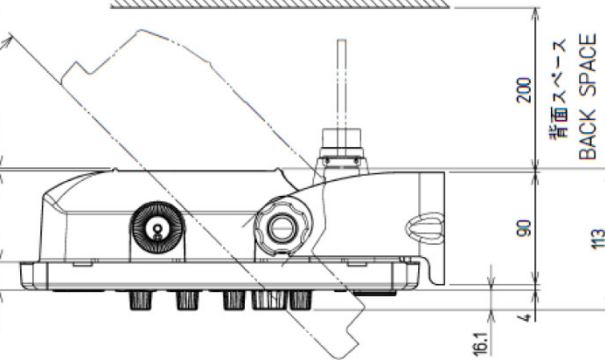
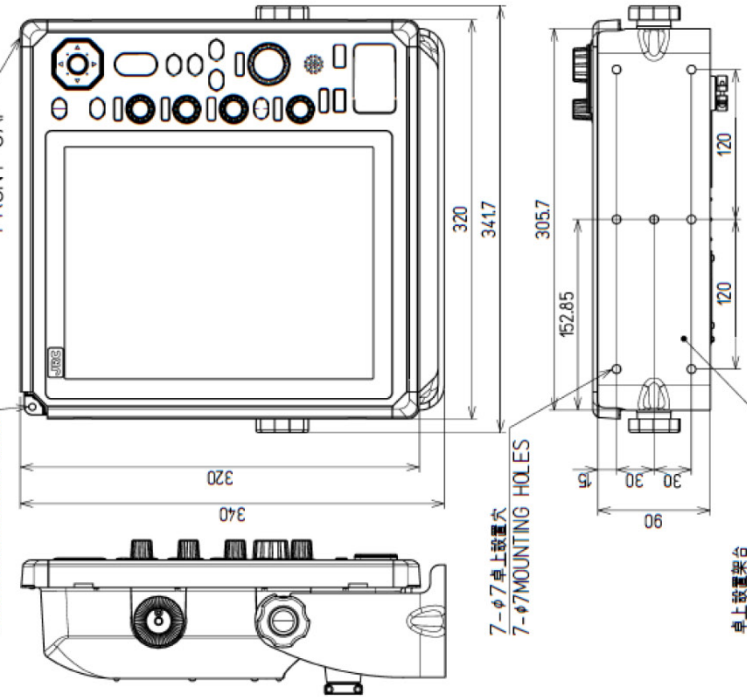
リアケース  
色: N2.5  
REAR CASE  
COLOR: N2.5

フロントパネル  
色: N2.5  
FRONT PANEL  
COLOR: N2.5

フロントキャップ  
FRONT CAP

4-φ5.5 前面設置穴  
4-φ5.5 FLUSH MOUNTING HOLES

7-φ7 卓上設置穴  
7-φ7 MOUNTING HOLES

卓上設置架台  
色: N2.5  
MOUNTING BRACKET  
COLOR: N2.5

重量 MASS 4.9kg  
単位 UNIT mm  
NCD-2364/JMA-3400

レーダ指示機外形図  
RADAR DISPLAY UNIT OUTLINE DRAWING

## 13.3 EQUIPMENT OUTLINE

This equipment is a marine radar for vessels and work boats which consists of the display unit including 12-inch SVGA color LCD Monitor unit, Keyboard unit, radar processing circuit, TT processing circuit, AIS processing circuit and consists of the 2ft/3.9ft/4ft/6ft scanner unit. 2ft scanner unit is radome type. 3.9ft/4ft/6ft scanner units are open-array type. The operation can be realized intuitive and simple.

### 13.3.1 CONFIGURATION

- 1) Display unit NCD-2364
  - Integrated the 12 inch SVGA color LCD Monitor unit, Keyboard unit and Processing unit
- 2) Scanner unit
  - X-band 2ft (4kW)                      radome type                      NKE-2043
  - X-band 3.9ft (6kW)                  open-array type                  NKE-2063A/AHS
  - X-band 4ft (10kW)                  open-array type                  NKE-2103-4/4HS
  - X-band 6ft (10kW)                  open-array type                  NKE-2103-6/6HS

### 13.3.2 FEATURE

- 1) The screen resolution is 800x600dots (SVGA).
- 2) Highly efficient signal processing with FPGA.
- 3) TT function is prepared with DSP.
- 4) Real-time head-up function, AIS display function and chart drawing function with CPU.

### 13.3.3 RADAR MODEL

JMA-3404	2ft (4kW)	Standard model scanner: NKE-2043
JMA-3406	3.9ft (6kW)	Standard model scanner: NKE-2063A
JMA-3406HS	3.9ft (6kW)	High speed model scanner: NKE-2063AHS
JMA-3411-4	4ft (10kw)	Standard model scanner: NKE-2103-4
JMA-3411-4HS	4ft (10kw)	High speed model scanner: NKE-2103-4HS
JMA-3411-6	6ft (10kW)	Standard model scanner: NKE-2103-6
JMA-3411-6HS	6ft (10kW)	High speed model scanner: NKE-2103-6HS

## 13.4 GENERAL SPECIFICATIONS

(1) Class of Emission	P0N
(2) Display	Color Raster Scan, PPI system
(3) Display capability	SVGA (800x600dots) Screen
(4) Screen	12.1-inch Color LCD Glass bonding Radar image effective diameter 150mm or more.
(5) Range Scale	0.0625, 0.125, 0.25, 0.5, 0.75, 1, 1.5, 2, 3, 4, 6, 8, 12, 16, 24, 32, 48, 64, 72NM *The used range can be disabled with user setting. (64, 72 NM or maximum range: off-center function is not available. The maximum range of JMA-3404 is 48NM.)
(6) Range Resolution	Less than 30m
(7) Minimum Detective Range	Less than 40m
(8) Range Accuracy	Less than 1% of the maximum distance of the range scale in use or less than 15m whichever is larger.
(9) Bearing Accuracy	Less than $\pm 1^\circ$
(10) Bearing Indication	RM: Head-up, North-up, Course-up TM: North-up, Course-up
(11) Ambient Condition	
Standards	IEC60945 Ed.4.0 * Refer to the display unit specifications for detailed conditions.
Temperature:	
Scanner	Operation: -25 to +55°C / Storage: -25 to +70°C
Display Unit	Operation: -15 to +55°C / Storage: -15 to +70°C
Relative Humidity	+40°C, 93%
Vibration	2 to 13.2 Hz, amplitude $\pm 1$ mm 13.2 to 100 Hz @0.7 G
Velocity of the wind	100kn
Waterproof/dustproof	Scanner           IP26 Display unit      IP55 * Refer to the display unit specifications for detailed conditions.
(12) Power Supply Input	DC+24V (All models, cable length of 30m or less) DC+12V (JMA-3404, JMA-3406, cable length of 20m or less. *High speed model JMA-3406HS can not use DC12V.)

(13) Power Consumption:	In calm wind	Maximum (Velocity of the wind: 100 kn)
JMA-3404	Approx. 60W	Approx. 60W
JMA-3406	Approx. 85W	Approx. 180W
JMA-3406HS	Approx. 85W	Approx. 230W
JMA-3411-4	Approx. 100W	Approx. 210W
JMA-3411-4HS	Approx. 100W	Approx. 360W
JMA-3411-6	Approx. 100W	Approx. 210W
JMA-3411-6HS	Approx. 100W	Approx. 360W

(14) Range of power supply voltage fluctuation

+10.8 to 31.2 VDC (Display Unit) (JMA-3404, JMA-3406)

\* JMA-3404/JMA-3406 input voltage upper limit is +30% of DC24V.

+21.6 to 31.2 VDC (Display Unit)

(JMA-3406HS, JMA-3411-4/4HS/6/6HS)

DC12/24V -10%/+30%

(15) Pre heat time

Approx. within 1min30sec.

(16) Display unit

Refer to Display unit Specifications

(17) Inter-unit Cables

Option

Length selectable (CFQ-6912-5/10/15/20/30m)

When using JMA-3404 and JMA-3406 with 12V DC, the maximum cable length is 20m or less.



## 13.5 SCANNER

### 13.5.1 SCANNER (NKE-2043) SPECIFICATION

- |  |  |   |
|--|--|---|
| (1) Dimensions                                   | Height 275mm × Diameter of radome 620mm                  |   |
| (2) Mass   | Approx. 10kg   |   |
| (3) Polarization                                 | Horizontal Polarization                                  |   |
| (4) Directional Characteristic                   |  |   |
|  | Horizontal Beam Width (-3dB):                            | 4°  |
|  | Vertical Beam Width (-3dB):                              | 25°   |
|  | Sidelobe Level:  | -21dB or less (less than ±10° from the main lobe)                     |
| (5) Rotation                                     | Approx. 48rpm<br>(16/20/24/27/30/36/42/48rpm can be set) |   |
| (6) Peak Power                                   | 4 kW   |   |
| (7) Transmitting Frequency                       | 9410 ±30MHz  |   |
| (8) Transmitting Tube                            | Magnetron [MSF1421B]                                     |   |
| (9) Pulse width/Repetition Frequency (Bandwidth) | SP1:   | 0.08μs/4000Hz (20MHz)   |
|  | SP2:   | 0.08μs/2250Hz (20MHz)   |
|  | SP3:   | 0.13μs/1700Hz (20MHz)   |
|  | MP1:   | 0.25μs/1700Hz (6MHz)  |
|  | MP2:   | 0.5μs/1200Hz (3MHz)   |
|  | LP1:   | 0.8μs/750Hz (3MHz)  |
|  | LP2:   | 1.0μs/650Hz (3MHz)  |
| (10) Range information                           | 0.0625NM to 0.25NM: SP1                                  |   |
|  | 0.5NM:   | SP1, MP1  |
|  | 0.75NM, 1NM:   | SP2, MP1  |
|  | 1.5NM:   | SP2, MP1, MP2   |
|  | 2NM to 4NM:  | SP3, MP1, MP2   |
|  | 6NM to 16NM:   | MP2, LP1, LP2   |
|  | 24NM to 48NM:  | LP2   |
| (11) Duplexer                                    | Circulator + Diode Limiter                               |   |
| (12) Front End Module                            | MIC  |   |
| (13) Intermediate Frequency Amplifier            |  |   |
|  | Intermediate Frequency:                                  | 60MHz   |
|  | Band Width:  | 20MHz (0.08μs, 0.13μs)<br>6MHz (0.25μs)<br>3MHz (0.5μs, 0.8μs, 1.0μs) |
|  | Gain:  | More than 90dB  |
|  | Amplifying Characteristics:                              | Logarithmic Amplifier   |
| (14) Overall Noise Figure                        | 6dB (Average)  |   |
| (15) Tune  | AUTO/MANUAL  |   |

## 13.5.2 SCANNER (NKE-2063A/AHS) SPECIFICATION

- |  |   |  |
|--|---|--|
| (1) Dimensions                                   | Height 419.5mm × Swing Circle 1220mm  |  |
| (2) Mass   | Approx. 21kg  |  |
| (3) Polarization                                 | Horizontal Polarization   |  |
| (4) Directional Characteristic                   |   |  |
|  | Horizontal Beam Width (-3dB):   | 2°   |
|  | Vertical Beam Width (-3dB):   | 30°  |
|  | Sidelobe Level:   | -23dB or less (less than ±10° from the main lobe)<br>-26dB or less (±10° or more from the main lobe) |
| (5) Rotation                                     | Approx. 27rpm (NKE-2063A)<br>(16/17.4/19/20.6/22.2/23.8/25.4/27rpm can be set)<br>Approx. 48rpm (NKE-2063AHS)<br>(27/36/48rpm can be set) |  |
| (6) Peak Power                                   | 6 kW  |  |
| (7) Transmitting Frequency                       | 9410 ±30MHz   |  |
| (8) Transmitting Tube                            | Magnetron [MSF1422B]  |  |
| (9) Pulse width/Repetition Frequency (Bandwidth) | SP1:  | 0.08μs/4000Hz (20MHz)  |
|  | SP2:  | 0.08μs/2250Hz (20MHz)  |
|  | SP3:  | 0.13μs/1700Hz (20MHz)  |
|  | MP1:  | 0.25μs/1700Hz (6MHz)   |
|  | MP2:  | 0.5μs/1200Hz (3MHz)  |
|  | LP1:  | 0.8μs/750Hz (3MHz)   |
|  | LP2:  | 1.0μs/650Hz (3MHz)   |
| (10) Range information                           | 0.0625NM to 025NM: SP1  |  |
|  | 0.5NM:  | SP1, MP1   |
|  | 0.75NM, 1NM:  | SP2, MP1   |
|  | 1.5NM:  | SP2, MP1, MP2  |
|  | 2NM to 4NM:   | SP3, MP1, MP2  |
|  | 6NM to 16NM:  | MP2, LP1, LP2  |
|  | 24NM to 72NM:   | LP2  |
| (11) Duplexer                                    | Circulator + Diode Limiter  |  |
| (12) Front End Module                            | MIC   |  |
| (13) Intermediate Frequency Amplifier            |   |  |
|  | Intermediate Frequency:   | 60MHz  |
|  | Band Width:   | 20MHz (0.08 μ s, 0.13 μ s)<br>6MHz (0.25 μ s)<br>3MHz (0.5 μ s, 0.8 μ s, 1.0 μ s)                    |
|  | Gain:   | More than 90dB   |
|  | Amplifying Characteristics:   | Logarithmic Amplifier  |
| (14) Overall Noise Figure                        | 6dB (Average)   |  |
| (15) Tune  | AUTO/MANUAL   |  |

**13.5.3 SCANNER (NKE-2103-4/6/4HS/6HS) SPECIFICATION**

(1) Dimensions	Height: approx. 458 mm Swing Circle: approx. 1,320mm (4ft) Height: approx. 458 mm Swing Circle: approx. 1910 mm (6ft)
(2) Mass	Approx. 34 kg (4ft) Approx. 36 kg (6ft)
(3) Polarization	Horizontal Polarization
(4) Directional Characteristic	Horizontal Beam Width (-3dB): 1.8° (4ft), 1.2° (6ft)  Vertical Beam Width (-3dB): 20° (4ft/6ft) Sidelobe Level -26 dB or less (less than ±10° from the main lobe) (4ft/6ft) -30 dB or less (±10° or more from the main lobe) (4ft/6ft)
(5) Rotation	27rpm (NKE-2103-4/6) 48rpm (NKE-2103-4HS/6HS)
(6) Transmitting Frequency	9410 ±30 MHz
(7) Peak Power	10 kW ±50%
(8) Transmitting Tube	Magnetron [MAF1565N]
(9) Pulse Width/Repetition Frequency (Bandwidth)	SP: 0.08μs/2250 Hz (20MHz) MP1: 0.25μs/1700 Hz (6MHz) MP2: 0.5μs/1200 Hz (6MHz) LP1: 0.8μs/750 Hz (3MHz) LP2: 1.0μs/650 Hz (3MHz)
(10) Range information	0.0625NM to 0.25NM: SP 0.5NM to 1NM: SP, MP1 1.5NM, 2NM: SP, MP1, MP2 3NM, 4NM: MP1, MP2, LP1 6NM to 16NM: MP2, LP1, LP2 24NM to 72NM: LP2
(10) Duplexer	Circulator + Diode Limiter
(11) Front End Module	MIC
(12) Intermediate Frequency Amplifier	Intermediate Frequency: 60MHz Band Width: 20MHz (0.08μs) 6MHz (0.25μs, 0.5μs) 3MHz (0.8μs, 1.0μs) Gain: More than 90dB Amplifying Characteristics: Logarithmic Amplifier
(13) Overall Noise Figure	7.5dB (Average)
(14) Tune Method	AUTO/MANUAL

## 13.6 DISPLAY

### 13.6.1 INTEGRATED DISPLAY UNIT (NCD-2364)

1) Structure	Desk Top Integrated Type (LCD Monitor Unit/Keyboard Unit/Processor Unit Integrated Structure) Vertical installation only desk top integrated type
2) Dimensions	Without bracket and side knob Height 320mm × Width 320mm × Depth 95.1mm Including bracket and side knob Height 340mm × Width 342mm × Depth 95.1mm (Depth is the depth from the front panel, not including the control knobs.)
3) Mass	Approx. 5 kg
4) Tune Method	Manual / Auto (Bar-graph indication is displayed at the time of adjustment.)
5) STC (SEA)	Manual / Auto
6) FTC (RAIN)	Manual / Auto
7) Radar Interference Rejection	Built-in (The effect can be adjusted by three stages.)
8) Bearing Marker	360° in 5° digit
9) Heading Line	Electronic (Can be temporarily hidden)
10) Off Center	Move to the defined coordinates of 4 patterns
11) True Motion Unit	Built-in (Not available at the maximum range)
12) True Motion Reset Position	66% of radius of any range
13) Radar trail indication	True motion mode: Only true motion trails Relative motion mode: True or relative motion trails Trail time length: Short: 15sec/30sec/1min/2min/3min/4min/5min/6min /10min/15min/Continuous Middle: 30sec/1min/2min/3min/4min/5min/6min/10min /15min/30min/Continuous Long: 1min/2min/3min/4min/5min/6min/10min/15min/ 30min/1hr/Continuous Super Long: 30min/1hr/2hr/3hr/4hr/5hr/6hr/10hr/12hr /24hr/Continuous The trail length can be switched instantaneously. Possible to display time series trail and continuous trail by color classification. Even if the movement mode, bearing mode, or range is changed, the radar trails can be taken over.

14) Variety of Pulse width	JMA-3404, JMA-3406/HS SP1/SP2/SP3/MP1/MP2/LP1/LP2 JMA-3411-4/4HS/6/6HS SP/MP1/MP2/LP1/LP2
15) Target enhance	4 stages
16) Plotting	
Line/Own Track	7 colors (White, Cyan, Blue, Green, Yellow, Pink, Red) 3 types (solid line, dashed line (short), dashed line (long)) The maximum number of Line:3,000 The maximum number of Own Track:10,000
Mark/Own Ship Mark	4 types (X, +, Y, ⚓) 2 sizes (Small, Large) 7 colors (White, Cyan, Blue, Green, Yellow, Pink, Red) The maximum number of Mark:3,000 The maximum number of Own Ship Mark:3,000
17) Display color	
Radar echo	8 colors (Yellow, Green, Orange, Pink, Red, White, Color, Custom)
Radar trails	Time trails: 3 colors (Cyan, White, Green) Continuous trails: 3 colors (Dark Green, Gray, Navy Blue)
Background (inner PPI)	4 colors (Blue, Navy Blue, Black, White)
Background (outer PPI)	4 colors (Blue, Navy Blue, Black, White)
Characters	7 colors (White, Cyan, Orange, Green, Black, Red, Amber)
AIS/TT	3 colors (Cyan, Green, White)
EBL/VRM	6 colors (Cyan, Green, Orange, Black, Pink, White)
Cursor	4 colors (Red, Yellow, Pink, White)
Own Ship/Barge	4 colors (White, Cyan, Green, Red)
Range Ring	6 colors (Cyan, Orange, Red, Green, White, Amber)
Guard Zone	5 colors (White, Green, Orange, Black, Red)
18) Simulator	Built-in
19) Multiple languages	English, Japanese, Other one optional language
20) Range Unit	NM, km, sm
21) Data-OFF screen	Only minimal information. Display radar image in full screen.
22) TLL Transmit	TLL (NMEA sentence) can be transmitted to the external device by pressing the operation button.
23) Screen Capture	Screen can be captured by pressing button or automatically (saved in USB memory).
24) Barge Outline	Display 1 ship (own ship + barge).
25) GPS receiver	JRC GPS receivers (JLR-4340, JLR-4341) can be connected, GPS settings and reception status can be checked.
26) Navigation information	Standard Built-in The standby screen can be changed to a graphical screen.

- 27) AIS information display      Refer to AIS function.
- 28) TT function Built-in      Refer to TT function.
- 29) Waypoint display      One mark of position information

## 30) Interface

DVI port	DVI-D 1 port. SVGA (800 × 600 pixel)
GPS port	1 port Can be used as a JRC GPS port or NMEA0183 (NMEA4 TX/RX) port. Compatible with IEC61162-1/2 equivalent when used as NMEA0183 port.
NMEA0183 port	3 ports (NMEA1 to NMEA3 TX/RX) Compatible with IEC61162-1/2 equivalent
LAN port	1 port. Communication between JMA-3400 and display unit.
Dry contact output	Output the external alarms. Normally Open only.
Contact input	Input the event marks.
CHART CARD port	Support for new pec and Navionics+ charts.
USB port	2 ports (front/rear).

Front port: Save internal data.

Rear port: For mouse / trackball connection only.

## 31) Waterproof/dustproof

IP55. However, the following usage conditions are assumed.

The front "CHART CARD/USB" cover is closed.

Close the "USB, LAN, DVI" cover on the back.

The optional rubber cap (MTT317838) is attached to the cable connected to the "SCANNER" connector on the back.

## 32) EMC

IEC60945 Ed.4.0

However, this is not applicable if any of the following ports are used.

- "CHART CARD/USB" port on the front.
- "USB, DVI" port on the back.

## 13.6.2 OPERATIONAL PART

- |                    |   |
|--------------------|---|
| 1) Structure       | Integrated on the display unit                                |
| 2) POWER ON/OFF    | ON: [STBY]<br>OFF: Press [STBY] and [TX / PRF] simultaneously |
| 3) Pointing device | Cross key   |
| 4) Keys            | ENT, CLR, MENU, FUNC, USER1, USER2, EBL, VRM, TX/PRF, STBY    |
| 5) Controls        | GAIN, SEA, RAIN, BRILL, MULTI                                 |

### 13.6.3 AIS FUNCTION (STANDARD BUILT IN)

- 1) Display
 

Number of targets	Up to 100 targets (stores up to 1,000 ship static data)
Target information	Displays MMSI, call sign, ship name, COG, SOG, CPA, TCPA, direction, distance.
Filters	Distance only (initial setting value 20NM)
Constant information display	1 ship The AIS information of the selected ship can be displayed on the screen constantly (exclusive to the TT constant information display).
Dangerous ship targets	No CPA/TCPA decision
- 2) Operation
- 3) Installation

### 13.6.4 TT FUNCTION (STANDARD BUILT IN)

- 1) Acquisition
- 2) Tracking
- 3) Display
 

Constant information display	1 ship The TT information of the selected 1 ship can be displayed on the screen constantly (exclusive to the AIS constant information display).
Maximum tracking range	20NM (This varies depending on the range)
Target information	Displays items are true bearing, distance, true course, and true speed.
Display of Vectors	True/Relative
Dangerous ship targets	Decision by CPA/TCPA
- 4) Operation



## 13.7 INPUT/ OUTPUT SIGNAL

### 13.7.1 INPUT ENABLE SIGNAL

- NMEA0183 input sentences

(1) Navigation equipment

Lat/Lon: GGA>RMC>RMA>GNS>GLL  
 SOG/COG: RMC>RMA>VTG  
 Log speed: VBW>VHW  
 HEADING: THS>HDT>HDG>HDM  
 DEPTH: DPT>DBT  
 WATER TEMP: MTW  
 ROT: ROT  
 RUDDER: RSA  
 AIS: VDM, VDO, ALR  
 WIND: MWV>VWT, VWR  
 WAYPOINT: RMB>BWC>BWR

(2) Bearing signal THS>HDT>HDG>HDM

(3) Speed signal VBW, VHW

- CAN input PGN

Data	CAN	
	PGN	Contents
Log speed	128259	Speed, water referenced
Depth	128267	Including relative to the transducer and offset.
Cross Track Error	129283	Provides the magnitude of position error perpendicular to the desired course.
Navigation data	129284	An essential navigation data for following a route.
WP information	129285	Route and WP data ahead in the Active Route
COG/SOG	130578	COG and SOG, rapid update
Longitude/Latitude	127250	GNSS position data
Water Temp	130310	Water temperature

### 13.7.2 OUTPUT POSSIBLE SIGNAL

- NMEA0183 output sentences

(1) Navigation equipment

Radar date: RSD

Own ship's data: OSD

TT data: TTM, TLL, TTD

Latitude/ Longitude data: GGA, RMC, GNS, GLL,

COG/SOG: RMC, VTG (Received GPS data)

Bearing signal: THS, HDT (Received GPS Compass data)

(2) External Buzzer Open collector contacts one port. (NMEA cable option necessary)

(3) Output RGB signal

- CAN output PGN

PGN	Contents	Explanation
128259	Speed, water referenced	A single transmission
128267	Water depth	Including relative to the transducer and offset.
129283	XTE	Position error perpendicular to the desired course.
129284	Navigation Data	An essential navigation data for following a route.
129285	Navigation-Route/WP information	Route and WP data ahead in the Active Route.
129026	COG, SOG rapid update	Provides COG and SOG.
129029	GNSS position	GNSS parameters, including position information.
130310	Water temp	Water temperature

### 13.7.3 STANDARD CONFIGURATION

Scanner: 1unit

Display Unit: 1unit

Power cable: 1pc. (3m)

Instruction manual: 1 book (Including Installation manual and Quick manual)

### 13.7.4 OPTION CABLE

Installation cable:

Cable length	Cable type
5m	CFQ-6912-5
10m	CFQ-6912-10
15m	CFQ-6912-15
20m	CFQ-6912-20
30m	CFQ-6912-30

NMEA cable (waterproof (IPX5)):

Description	Cable type
CFQ-9002	GPS cable
CFQ-5374	NMEA0183 cable
CFQ-7765	CAN cable (Connector kinds: Socket side – Socket side)
CFQ-7836	GPS compass connection cable

(MEMO)

# APPENDIX

## NKE-2043 SCANNER INTERCONNECTION DIAGRAM

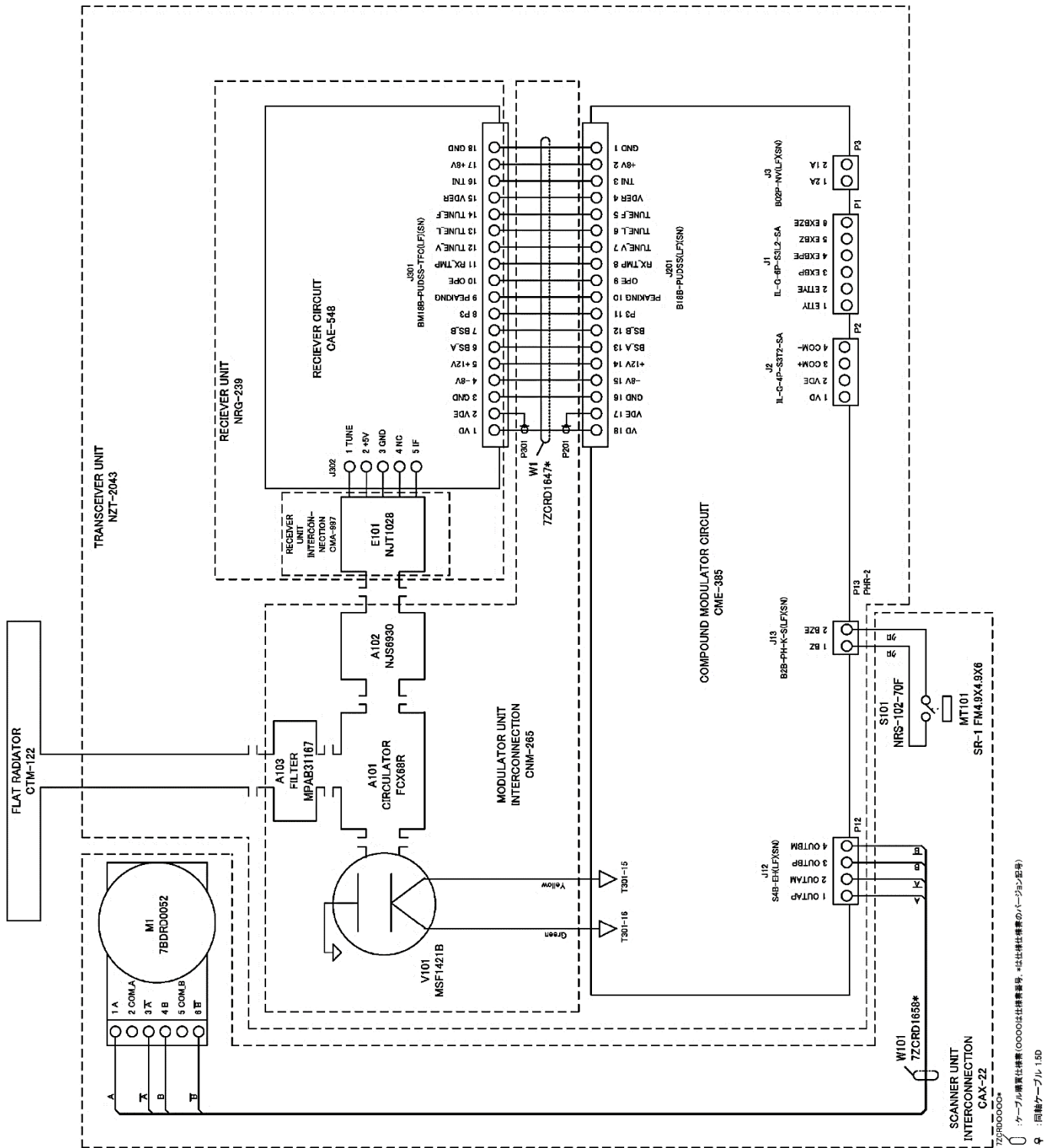

FIG A1

\* ケーブル購買仕様書(0000)は仕様番号、\*は仕様書のバージョン番号)  
 7ZCRD0000\*  
 9 : 同軸ケーブル 1.5D





# NKE-2103-4/4HS/6/6HS SCANNER INTERCONNECTION DIAGRAM

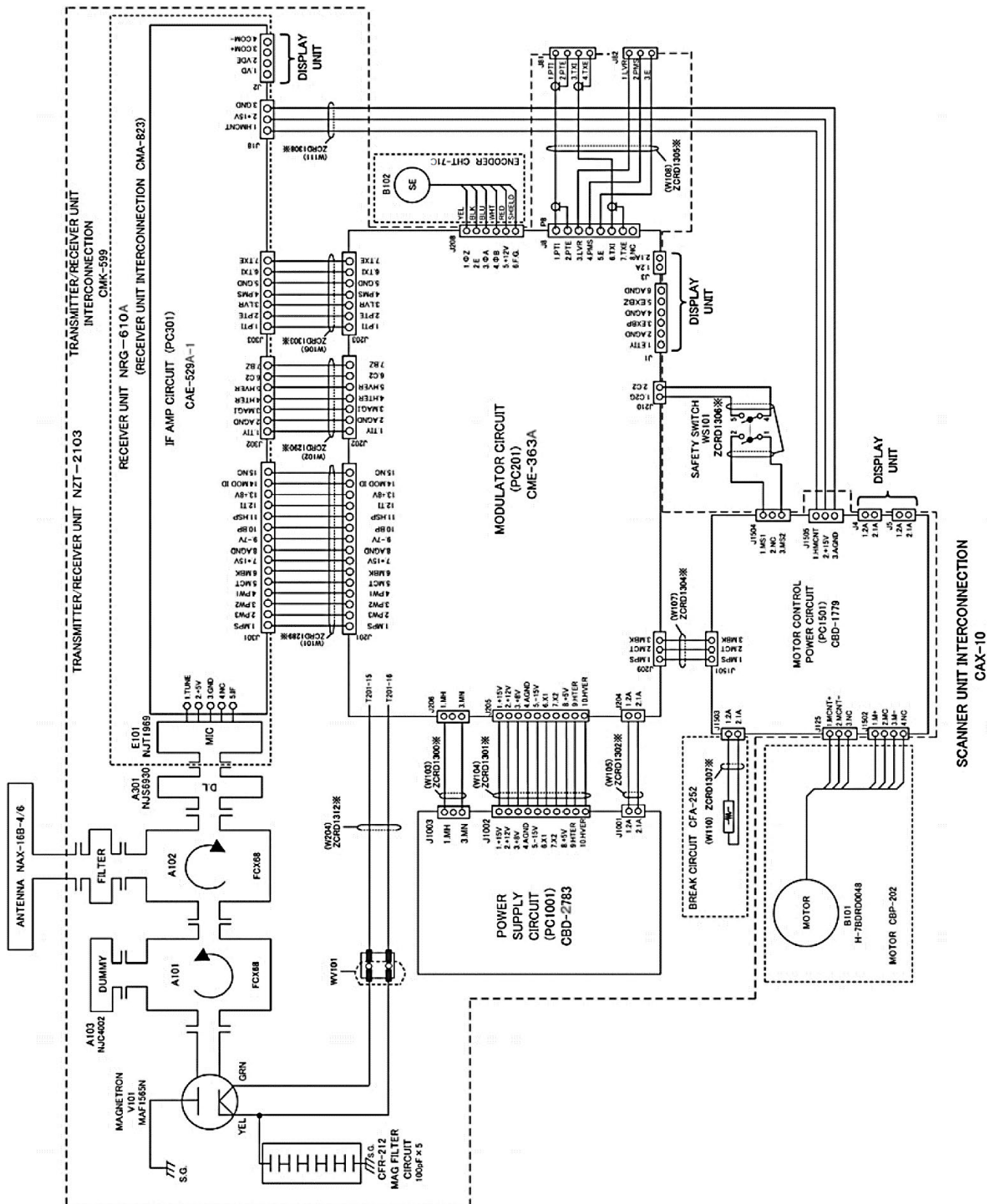

FIG A4

# NCD-2364 DISPLAY UNIT INTER CONNECTION DIAGRAM

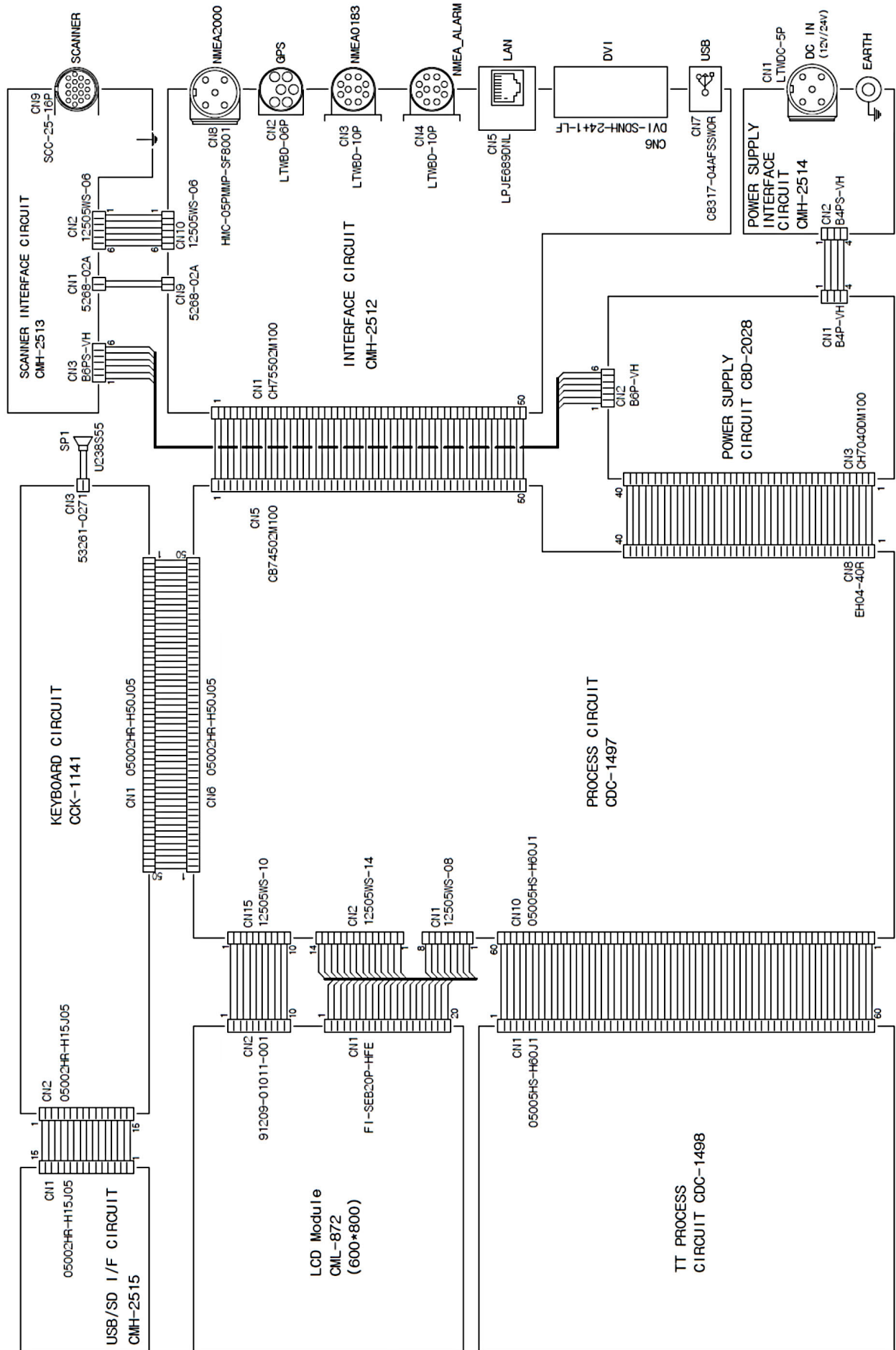
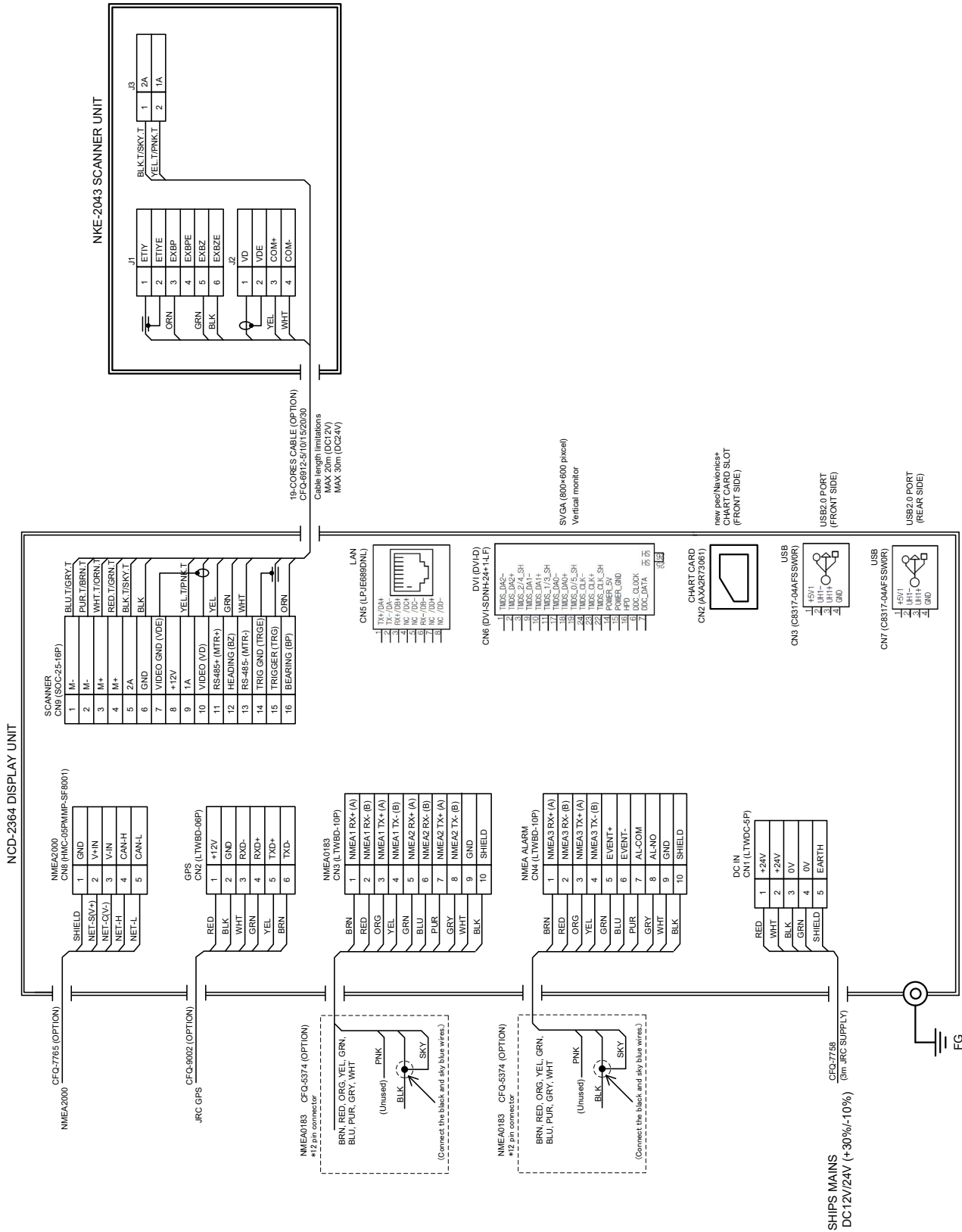

FIG A5





# JMA-3404 INTERCONNECTION DIAGRAM



# JMA-3406/HS INTERCONNECTION DIAGRAM

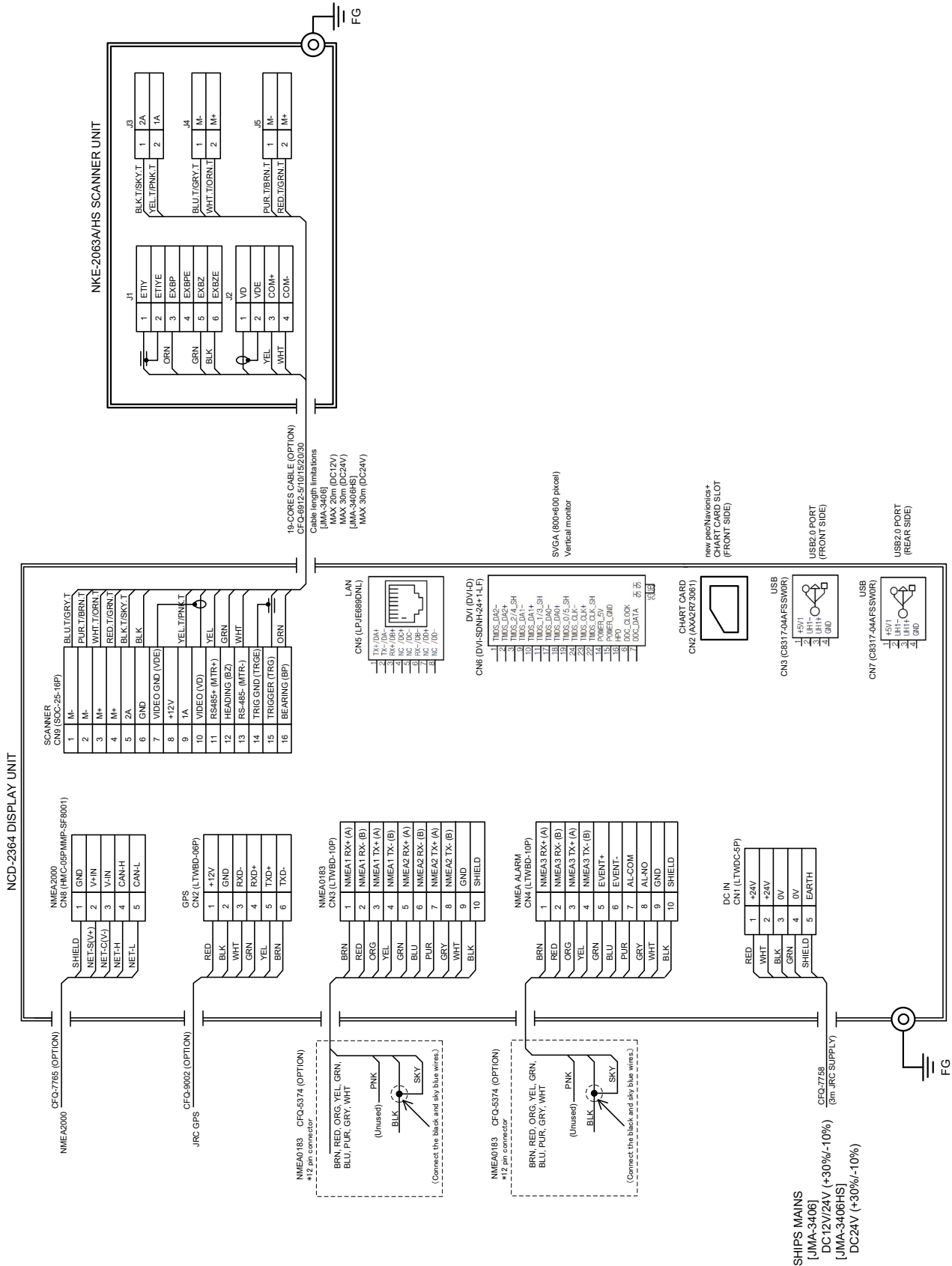

FIG A8



(MEMO)

# MENU FUNCTION LIST





## Main Menu

Item	Setting Contents
1. User	
1. USER1 short press	Release / Cancel
2. USER2 short press	Release / Cancel
3. USER1 long press	Release / Cancel
4. USER2 long press	Release / Cancel
2. RADAR Echo	
1. Pulse Width	SP1 / SP2 / MP1 / MP2 / LP1 / LP2 / LP3
2. IR	OFF / Low / Middle / High
3. Target Enhance	OFF / Level1 / Level2 / Level3
4. Process	OFF / 3Scan CORREL / 4Scan CORREL / 5Scan CORREL / Remain / Peak Hold
5. Zoom Mode	OFF / Zoom x2 / Zoom Circle
6. Video Noise Rejection	OFF / Level1 / Level2 / Level3
7. Video Latitude	Narrow / Normal / Wide1 / Wide2 / Max
3. Tune	Manual / Auto
4. Marker	
1. EBL1 Setting	
1. Floating	Off / Screen Fix / Lat/Lon Fix
2. Bearing Mode	True / Relative
2. EBL2 Setting	
1. Floating	Off / Screen Fix / Lat/Lon Fix
2. Bearing Mode	True / Relative
3. Parallel Cursor	
1. Range Scale Link	Off / On
2. Floating	Off / Screen Fix / Lat/Lon Fix
3. Bearing Mode	Angle Fix / Screen Fix / Heading Fix
4. One / Both Sides	One Side / Both Sides
5. Display For Individual Line1	Off / On
6. Display For Individual Line2	Off / On
7. Display For Individual Line3	Off / On
8. Display For Individual Line 4	Off / On
9. Display For Individual Line5	Off / On
10. Display For Individual Line 6	Off / On
11. Display For Individual Line 7	Off / On
4. VRM Unit	NM / km / sm / Link Range
5. Cursor Mode	
1. Bearing Mode	True / Relative
2. Unit	NM / km / sm / Link Range
3. Size	Small / Large
4. Pattern	Thin Cross / Thin Cross(Empty on Center) / Thick Cross / Thick Cross(Empty on Center)
6. Range Ring	Off / On
5. Set Own Ship Movement	
1. TM/RM	RM / TM
2. Bearing Mode	Head Up / North Up / Course Up / Course Up Reset
6. Trails	
1. Threshold	Level1 / Level2 / Level3 / Level4
2. Time/All Combine	Off / On

Item	Setting Contents
3. Trails Mode	True / Relative
7. Vector	
1. Vector Mode	True / Relative
2. Display Own Ship's Vector	Off / On
3. Own Ship Vector Line Width	1~5
8. Offcenter	
1. Set Position	
2. Remove	
9. Function Setting	
1. Standard	
1. Function Enable/Disable	Off / On
2. IR	OFF / Low / Middle / High
3. Process	OFF / 3Scan CORREL / 4Scan CORREL / 5Scan CORREL / Remain / Peak Hold
4. Target Enhance	OFF / Level1 / Level2 / Level3
5. AUTO STC/FTC	OFF / AUTO STC / AUTO FTC / AUTO STC + AUTO FTC
6. Video Latitude	Narrow / Normal / Wide1 / Wide2 / MAX
7. Video Noise Rejection	OFF / Level1 / Level2 / Level3
8. Trails Interval	Short: OFF / 15sec / 30sec / 1min / 2min / 3min / 4min / 5min / 6min / 10min / 15min / Continuous Middle: OFF / 30sec / 1min / 2min / 3min / 4min / 5min / 6min / 10min / 15min / 30min / Continuous Long: OFF / 1min / 2min / 3min / 4min / 5min / 6min / 10min / 15min / 30min / 1time / Continuous Super long: OFF / 30min / 1time / 2time / 3time / 4time / 5time / 6time / 10time / 12time / 24time / Continuous
9. Trails Mode	True / Relative
10. Threshold	Level1 / Level2 / Level3 / Level4
11. Time/All Combine	OFF / ON
12. MAX Interval	Short / Middle / Long / Super Long
13. PRF	Normal / Economy / High Power
14. Antenna Height	-5m / 5-10m / 10-20m / 20m - / USER
15. Save Present State	
16. Reset To User Default	
17. Initialize	
2. Coast	Same setting as standard
3. Deepsea	Same setting as standard
4. Fishnet	Same setting as standard
5. Bird	Same setting as standard
6. User	Same setting as standard
10. AIS / TT	
1. TT Function On/Off	OFF / ON
2. AIS Function On/Off	OFF / ON
3. CPA Limit	0.0~9.9NM
4. TCPA Limit	0~99min
5. CPA Ring	OFF / ON
6. TT Target Number Display	OFF / ON
7. AIS Target Number Display	OFF / ON
8. Target Number Allocation	OFF / ON
1. TT	00~70
2. AIS	100~900
9. TLL Target Number Allocation	
1. Allocation	Own Ship's / Cursor
2. Own Ship's	00~99

Item	Setting Contents
3. Cursor	00~99
10. ALR Alarm From AIS	Off / On
11. AIS Display Target	10 / 20 / 30 / 40 / 50 / 60 / 70 / 80 / 90 / 100
12. AIS Destination Ship	000000000~999999999
13. AIS Retrieved Vessel	
1. AIS Retrieved Vessel #1	000000000 ~ 999999999
2. AIS Retrieved Vessel #2	000000000 ~ 999999999
3. AIS Retrieved Vessel #3	000000000 ~ 999999999
4. AIS Retrieved Vessel #4	000000000 ~ 999999999
5. AIS Retrieved Vessel #5	000000000 ~ 999999999
6. AIS Retrieved Vessel #6	000000000 ~ 999999999
7. AIS Retrieved Vessel #7	000000000 ~ 999999999
8. AIS Retrieved Vessel #8	000000000 ~ 999999999
9. AIS Retrieved Vessel #9	000000000 ~ 999999999
10. AIS Retrieved Vessel #10	000000000 ~ 999999999
14. AIS Filter	0.0 ~ 72.0NM
11. Guard Zone	
1. Zone1 Alarm Level	Level1 / Level2 / Level3 / Level4
2. Zone1 Alarm Mode	OFF / Display / In / Out / Auto TT
3. Make Zone1	
4. Zone2 Alarm Level	Level1 / Level2 / Level3 / Level4
5. Zone2 Alarm Mode	OFF / Display / In / Out
6. Make Zone2	
12. Waypoint Display	Off / On
13. Chart	
1. Type	new pec / Navionics+
2. Display	Off / On
3. Symbol	Off / On
1. Lat/Lon grid	Off / On
2. Depth Grid	Off / On
3. Lighthouse	Off / On
4. Buoy	Off / On
5. Wreck Ship	Off / On
6. Fish Haven	Off / On
7. Sea Lane	Off / On
8. Restricted Area	Off / On
9. Fishing Area	Off / On
10. Sea Cable	Off / On
11. Name	Off / On
12. Mark Attribute	Off / On
13. etc.	Off / On
4. Palette	Day / Night
5. Show extend Data	Off / On
14. Set Chart Operation	
1. Set Operation	Press 1 time, recover 3 seconds later / Press once, delete mutual / Press 1 time, recover 8 seconds later
2. Delete Map Temporarily	When selected, the function is executed according to the execution operation setting.
3. Delete Echo Temporarily	When selected, the function is executed according to the execution operation setting.
15. Mark	
1. Mark Size	Small / Large



Item	Setting Contents
2. Mark Color	White / Cyan / Blue / Green / Yellow / Pink / Red
3. Mark Type	× / + / Y / 
4. Display Mark Color	
1. All	All / Individual
2. White	Off / On
3. Cyan	Off / On
4. Blue	Off / On
5. Green	Off / On
6. Yellow	Off / On
7. Pink	Off / On
8. Red	Off / On
5. Display Mark Type	
1. All	All / Individual
2. ×	Off / On
3. +	Off / On
4. Y	Off / On
5. 	Off / On
6. Mark List	
16. Ownship Mark	
1. Own Ship Position Mark Size	Small / Large
2. Own Ship Position Mark Color	White / Cyan / Blue / Green / Yellow / Pink / Red
3. Own Ship Position Mark Type	× / + / Y / 
4. Display Mark Type	
1. All	All / Individual
2. White	Off / On
3. Cyan	Off / On
4. Blue	Off / On
5. Green	Off / On
6. Yellow	Off / On
7. Pink	Off / On
8. Red	Off / On
5. Display Mark Type	
1. All	All / Individual
2. ×	Off / On
3. +	Off / On
4. Y	Off / On
5. 	Off / On
6. Own Ship Position Mark List	Mark list screen display
17. Line	
1. Line Color	White / Cyan / Blue / Green / Yellow / Pink / Red
2. Line Type	Solid Line / Dashed Line(Short) / Dashed Line(Long)
3. Display Line Color	
1. All	All / Individual
2. White	Off / On
3. Cyan	Off / On
4. Blue	Off / On
5. Green	Off / On
6. Yellow	Off / On
7. Pink	Off / On
8. Red	Off / On
4. Display Line Type	
1. All	All / Individual

Item	Setting Contents
2. Solid Line	Off / On
3. Dashed Line(Short)	Off / On
4. Dashed Line(Long)	Off / On
5. Line List	Mark list screen display
18. Own Track	
1. Own Track Record On/Off	Off / On
2. Own Track Record Display On/Off	Off / On
3. Own Track Color	White / Cyan / Blue / Green / Yellow / Pink / Red
4. Own Track Type	Solid Line / Dashed Line(Short) / Dashed Line(Long)
5. Own Track Interval	3Seconds / 5Seconds / 10Seconds / 30Seconds / 1Minutes / 3Minutes / 5Minutes / 10Minutes / 30Minutes / 60Minutes / 1NM / 3NM / 5NM / 10NM
6. Display Own Track Color	
1. All	All / Individual
2. White	Off / On
3. Cyan	Off / On
4. Blue	Off / On
5. Green	Off / On
6. Yellow	Off / On
7. Pink	Off / On
8. Red	Off / On
7. Display Own Track Color	
1. All	All / Individual
2. Solid Line	Off / On
3. Dashed Line(Short)	Off / On
4. Dashed Line(Long)	Off / On
8. Clear Own Track Color/Type	
1. Clear Own Track Color	All / White / Cyan / Blue / Green / Yellow / Pink / Red
2. Clear Own Track Type	All / Solid Line / Dashed Line(Short) / Dashed Line(Long)
3. Clear Own Track	
19. File Operation	
1. Save	
1. Mark/Line	
2. Own Ship Track	
2. Load	
1. Mark/Line	
2. Own Ship Track	
3. Delete	
1. Mark/Line	
2. Own Ship Track	
20. Screen Capture	
1. Capture Function	OFF / Manual / Auto
2. Set Manual Key	USER1 / USER2
3. Interval	10 ~ 999
21. Timed TX	
1. Timed TX	Off / On
2. TX Time	1 ~ 99 Scan
3. Standby Time	1 ~ 99 min
22. TLL TX "USER2"	Off / On
23. Certification Information	

## Adjust Menu

Item	Setting Contents
1. Basic Adjustment	
1. Bearing Adjustment	0.0 - 359.9°
2. Range Adjustment	0 - 999
3. Tune Adjustment	0 - 127
4. Antenna Height	~5m / 5~10m / 10~20m / 20m~ / USER
5. Language	English / Japanese / Language3 / Language4 / Language5 / ---- / Language19 / Language20 / Custom
2. RADAR Echo	
1. Noise Level	0 - 255
2. Main Bang Suppression	
1. Main Bang Suppression Area	0 - 255
2. Main Bang Suppression Slope	0 - 255
3. Main Bang Suppression Level	0 - 255
3. Target Enhance Level	Level1 / Level2 / Level3 / Level4
4. Gain	
1. Preset	0 - 255
5. Sea	
1. STC Curve Select	Sea / River
2. STC Slope Correction	0.0 - 2.0
3. STC Offset	0 - 9, A - F
6. Rain	
1. FTC Curve Select	Sea / River
2. FTC Slope Correction	0.0 - 2.0
3. FTC Offset	0 - 9, A - F
3. Trails	
1. Trails Suppression Distance	0 - 1000
2. Max Interval	Short / Middle / Long / Super Long
3. Range Limit	No Limit / Under 2 Range / Under 3 Range / Under 4 Range
4. TT	
1. Vector Constant	1 - 8
2. Gate Display	Off / On
3. Gate Size	0 - 64
5. Scanner	
1. Slope Correction	
2. PRF Fine Tuning	0 - 31
3. Stagger Trigger	Off / On
4. Scanner Rotation Speed	
1. SP1	0 - 7
2. SP2	0 - 7
3. SP3	0 - 7
4. MP1	0 - 7
5. MP2	0 - 7
6. LP1	0 - 7
7. LP2	0 - 7
5. PRF Output Mode	Normal / Economy / High Power
6. Safety Switch	TX-Off / Standby / TX-On / Ignore Error
7. Tune Peak Adjustment	0 - 127
8. Tune Indicator Level Adjustment	0 - 127
9. Stop antenna in the specified direction	
1. ON/OFF	Off / On
2. Angle	0 - 360
10. Ice Class Standby Mode	Off / On
6. I/F Device	
1. Heading Equipment	AUTO / GYRO/Compass / GPS / Manual

Item	Setting Contents
2. Manual Heading	0.0 - 359.9°
3. Speed Equipment	GPS / Log/2Log / Manual
4. Manual Speed	0.0 - 100.0 kn
5. MAG Compass Setting	
1. Heading Correction	Off / On
2. Correct Value	W9.9° - E9.9°
7. COM Port Setting	
1. Baud Rate	
1. GPS	Auto / 4800bps / 38400bps
2. NMEA1	Auto / 4800bps / 38400bps
3. NMEA2	Auto / 4800bps / 38400bps
4. NMEA3	Auto / 4800bps / 38400bps
2. Rx Sentence	
1. GPS ( Lat / Lon )	
1. GGA	Off / On
2. RMC	Off / On
3. RMA	Off / On
4. GNS	Off / On
5. GLL	Off / On
2. GPS ( COG / SOG )	
1. RMC	Off / On
2. RMA	Off / On
3. VTG	Off / On
3. Heading	
1. THS	Off / On
2. HDT	Off / On
3. HDG	Off / On
4. HDM	Off / On
5. VHW	Off / On
4. Depth	
1. DPT	Off / On
2. DBS	Off / On
3. DBT	Off / On
4. DBK	Off / On
5. Wind	
1. MWV	Off / On
2. VWT	Off / On
3. VWR	Off / On
6. WPT	
1. RMB	Off / On
2. BWC	Off / On
3. BWR	Off / On
3. Rx Port	
1. GYRO ·Compass	Auto / GPS / NMEA1 / NMEA2 / NMEA3
2. GPS	Auto / GPS / NMEA1 / NMEA2 / NMEA3 / NMEA2000
3. Log ·2Log	Auto / GPS / NMEA1 / NMEA2 / NMEA3 / NMEA2000
4. Depth	Auto / GPS / NMEA1 / NMEA2 / NMEA3 / NMEA2000
5. Temperature	Auto / GPS / NMEA1 / NMEA2 / NMEA3 / NMEA2000
6. Wind	Auto / GPS / NMEA1 / NMEA2 / NMEA3
7. WPT	Auto / GPS / NMEA1 / NMEA2 / NMEA3 / NMEA2000
8. Rate of Turn	Auto / GPS / NMEA1 / NMEA2 / NMEA3
9. Rudder	Auto / GPS / NMEA1 / NMEA2 / NMEA3
4. Tx Port	
1. TTM	Off / GPS / NMEA1 / NMEA2 / NMEA3
2. TLL	Off / GPS / NMEA1 / NMEA2 / NMEA3

Item	Setting Contents
3. TTD	Off / GPS / NMEA1 / NMEA2 / NMEA3
4. TLB	Off / GPS / NMEA1 / NMEA2 / NMEA3
5. GGA	Off / GPS / NMEA1 / NMEA2 / NMEA3
6. GLL	Off / GPS / NMEA1 / NMEA2 / NMEA3
7. RMC	Off / GPS / NMEA1 / NMEA2 / NMEA3
8. VTG	Off / GPS / NMEA1 / NMEA2 / NMEA3
9. OSD	Off / GPS / NMEA1 / NMEA2 / NMEA3
10. RSD	Off / GPS / NMEA1 / NMEA2 / NMEA3
11. THS	Off / GPS / NMEA1 / NMEA2 / NMEA3
12. HDT	Off / GPS / NMEA1 / NMEA2 / NMEA3
5. TX Data Format	
1. TX Interval	1 - 9 second
2. NMEA Version	V2.3 / V2.0 / V1.5
3. NMEA Talker	Normal / GP
6. Target Information TX	
1. TX Target	TT / AIS / TT/AIS
2. TTM Distance Accuracy	1 / 2 / 3
3. TTM Average Mode	Off / On
4. TTM Average Scan	2 - 10
8. Buzzer	
1. Key ACK	0 - 255
2. Operation Error	0 - 255
3. CPA/TCPA	0 - 255
4. AZ/Alarm Zone	0 - 255
5. Target Lost	0 - 255
6. System Alarm	0 - 255
7. External	
1. CPA/TCPA	Off / On
2. AZ/Alarm Zone	Off / On
3. Target Lost	Off / On
4. System Alarm	Off / On
5. Out of Range	Off / On
9. GPS	
1. NMEA Version	Auto / V1.5 / V2.1 / V2.3
2. GPS Setting	
1. Correction Method	GPS Single / SBAS / Beacon / AUTO
2. Fix Mode	2D / 3D / AUTO
3. Elevate Mask	5 - 89°
4. HDOP	4 / 10 / 20
5. Smooth Lat/Lon	0 - 99 sec(R34.00 - )
6. Smooth SOG	0 - 99 sec(R34.00 - )
7. Smooth COG	0 - 99 sec(R34.00 - )
8. Smoothing1	0 - 99 sec(R29.04 - R33.99) 1 - 99 sec(R26.01 - R29.03)
9. Smoothing2	0 sec / 10 sec / 40 sec( - R26.00)
10. RAIM Accuracy Level	Off / 10m / 30m / 50m / 100m
11. Exclusion Satellite	
1. Exclusion Satellite 1	0 - 32
2. Exclusion Satellite 2	0 - 32
3. Exclusion Satellite 3	0 - 32
4. Exclusion Satellite 4	0 - 32
5. Exclusion Satellite 5	0 - 32
6. Exclusion Satellite 6	0 - 32
12. Send Data	
13. GPS Adjust	
1. Position	

Item	Setting Contents
1. Latitude	S/N 0° 00.0000' - 90° 00.0000'
2. Longitude	E/W 0° 00.0000' - 180° 00.0000'
2. Antenna Height	0 - 8191
3. Time	00:00:00 - 23:59:59
4. Date	2010/01/01 - 2099/12/31
5. Master Reset	
6. Send Data	
3. Beacon Setting	
1. Select	AUTO / Manual
2. Frequency	283.5 - 325.0
3. Baud Rate	50bps / 100bps / 200bps
4. Send Data	
4. SBAS Setting	
1. Satellite Search	AUTO / Manual
2. Ranging	Off / On
3. SBAS Satellite Number	120 - 138
4. Send Data	
5. Display GPS Receive Status	
6. LORAN Setting	
1. Display Time Zone	Off / LORAN A / LORAN C
2. LORAN A	
1. Select 1	1S1 / 1S2 / 1S3 / 1S4 / 1S6 / 1L0 / 1L1 / 1L4 / 1L5 / 2S0 / 2S1 / 2S2 / 2S3 / 2S4 / 2S5 / 2S6 / 2S7 / 2H4 / 2H5 / 2H6
2. Select 2	1S1 / 1S2 / 1S3 / 1S4 / 1S6 / 1L0 / 1L1 / 1L4 / 1L5 / 2S0 / 2S1 / 2S2 / 2S3 / 2S4 / 2S5 / 2S6 / 2S7 / 2H4 / 2H5 / 2H6
3. TD1 Correction	0.0 - 9.9
4. TD2 Correction	0.0 - 9.9
3. LORAN C	
1. Chain	4990 / 5930 / 5970 / 5980 / 5990 / 6730 / 6731 / 6780 / 7001 / 7030 / 7170 / 7270 / 7430 / 7499 / 7930 / 7950 / 7960 / 7970 / 7980 / 7990 / 8000 / 8290 / 8390 / 8830 / 8930 / 8970 / 8990 / 9007 / 9610 / 9930 / 9940 / 9960 / 9970 / 9980 / 9990
2. TD1	0 - 99
3. TD2	0 - 99
4. TD1 Correction	0.0 - 9.9
5. TD2 Correction	0.0 - 9.9
10. Control	
1. Multi Control Menu Time Out	0 - 255
2. Cross Key Gain	1 - 5
3. Trackball Control	1 - 5
4. Multi Control	
1. EBL	1 - 5
2. VRM	1 - 5
3. Common	1 - 5
5. Gain Control	
1. Response Level	1 - 5
2. Gain Min Preset	0 - 127
3. Gain Max Preset	128 - 255
6. Sea Control	
1. Response Level	1 - 5
2. Sea Min Preset	0 - 127
3. Sea Max Preset	128 - 255
7. Rain Control	
1. Response Level	1 - 5
2. Rain Min Preset	0 - 127
3. Rain Max Preset	128 - 255
11. Maintenance	
1. Reset Partial	

Item	Setting Contents
1.RADAR Echo	
2. Function Setting	
3. Basic Adjustment	
4. Main Menu	
5. Adjust Menu	
6. System Information 1	
7. System Information 2	
8. All Menu	
2. Master Reset	
3.System Time Clear	
4. Scanner Time Clear	
1. Operation Time Clear	
2. TX Time Clear	
3. Motor Time Clear	
4. Scanner -> Display	
5. Display -> Scanner	
5. Table Update	
1. STC Curve	
2. Color	
3. Initial Value	
1. RADAR Echo	
2. Function Setting	
3. Basic Adjustment	
4. Main Menu	
5. Adjust Menu	
6. System Information 1	
7. System Information 2	
8. All Menu	
4. Insert Language	
5. Echo Simulation	
6. Internal Setting	
1. Internal Memory to USB	
1. RADAR Echo	
2. Function Setting	
3. Basic Adjustment	
4. Main Menu	
5. Adjust Menu	
6. System Information 1	
7. System Information 2	
8. All Menu	
2. USB to Internal Memory	
1. RADAR Echo	
2. Function Setting	
3. Basic Adjustment	
4. Main Menu	
5. Adjust Menu	
6. System Information 1	
7. System Information 2	
8. All Menu	
7. USB Format	
12. System Setting	
1. Master/Slave/Demo	Master / Slave / Demo
2. Own Outline	
1. On/Off	Off / On
2. Input Outline Size	

Item	Setting Contents
1. Full Length	0.0 - 600.0
2. Full Width	0.0 - 200.0
3. GPS Antenna(Length)	0.0 - 600.0
4. GPS Antenna(Side)	-100.0 - +100.0
5. Scanner(Length)	0.0 - 600.0
6. Scanner(Side)	-100.0 - +100.0
3. Barge Outline	
1. On/Off	Off / On
2. Input Outline Size	
1. Full Length	0.0 - 600.0
2. Full Width	0.0 - 200.0
3. Barge Position(Length)	-600.0 - +600.0
4. Barge Position(Side)	-200.0 - +200.0
4. Bearing Marker	
1. Bearing	Off / On
2. Bearing Step	0 - 99
5. Operation Numeric Display	Off / On
6 Unit	
1. Range	NM / km / sm
2. Distance	NM / km / sm
3. Speed	kn / km/h / mph
4. Depth	ft / fm/ m / user
5. User Depth	0.0001 - 9.9999
6. Temperature	°C / ° F
7. Wind	m/s / km/h / kt / Bft.
8. Size/Location Setting	m / ft
7. Move Own Ship	
1. Ship's Move	Lat/Lon / COG/SOG
8. Range	
1. NM	
1. 0.0625NM	Off / On
2. 0.125NM	Off / On
3. 0.25NM	Off / On
4. 0.5NM	Off / On
5. 0.75NM	Off / On
6. 1NM	Off / On
7. 1.5NM	Off / On
8. 2NM	Off / On
9. 3NM	Off / On
10. 4NM	Off / On
11. 6NM	Off / On
12. 8NM	Off / On
13. 12NM	Off / On
14. 16NM	Off / On
15. 24NM	Off / On
16. 32NM	Off / On
17. 48NM	Off / On
18. 64NM	Off / On
19. 72NM	Off / On
2. km	
1. 0.15km	Off / On
2. 0.3km	Off / On
3. 0.5km	Off / On
4. 0.8km	Off / On
5. 1.2km	Off / On



Item	Setting Contents
6. 1.6km	Off / On
7. 2km	Off / On
8. 4km	Off / On
9. 8km	Off / On
10. 16km	Off / On
11. 32km	Off / On
3. sm	
1. 0.0625sm	Off / On
2. 0.125sm	Off / On
3. 0.25sm	Off / On
4. 0.5sm	Off / On
5. 0.75sm	Off / On
6. 1sm	Off / On
7. 1.5sm	Off / On
8. 2sm	Off / On
9. 3sm	Off / On
10. 4sm	Off / On
11. 6sm	Off / On
12. 8sm	Off / On
13. 12sm	Off / On
14. 16sm	Off / On
15. 24sm	Off / On
16. 32sm	Off / On
17. 48sm	Off / On
18. 64sm	Off / On
19. 72sm	Off / On
13. Display Screen	
1. Standby Numeric Display	Off / On
2. Day	
1.Keyboard Unit Brilliance	Off / Level1 / Level2 / Level3 / Level4
2. Outer PPI	
1. Color	Black / Blue / Navy Blue / White
2. Brilliance	Level1 / Level2 / Level3 / Level4
3. Inner PPI	
1. Color	Blue / Navy Blue / Black / White
2. Brilliance	Level1 / Level2 / Level3 / Level4
4. Character	
1. Color	White / Cyan / Orange / Green / Black / Red / Amber
2. Brilliance	Level1 / Level2 / Level3 / Level4
5. RADAR Echo	
1. Color	Yellow / Green / Orange / Pink / Red / White / Color / Custom
2. Brilliance	Level1 / Level2 / Level3 / Level4
6. RADAR Trails(Time)	
1. Color	Cyan / White / Green
2. Brilliance	Level1 / Level2 / Level3 / Level4
7. RADAR Trails(All)	
1. Color	Dark Green / Gray / Navy Blue
2. Brilliance	Level1 / Level2 / Level3 / Level4
8. Own Ship's/Berge	
1. Color	White / Cyan / Green / Red
2. Brilliance	Level1 / Level2 / Level3 / Level4
9. Own Ship's Vector	
1. Color	White / Cyan / Green / Red
2. Brilliance	Level1 / Level2 / Level3 / Level4

Item	Setting Contents
10. Target( TT / AIS )	
1. Color	Cyan / Green / White
2. Brilliance	Level1 / Level2 / Level3 / Level4
11. EBL/VRM/Parallel	
1. Color	Cyan / Green / Orange / Black / Pink / White
2. Brilliance	Level1 / Level2 / Level3 / Level4
12. Range Ring	
1. Color	Cyan / Orange / Red / Green / White / Amber
2. Brilliance	Level1 / Level2 / Level3 / Level4
13. Cursor	
1. Color	Red / Yellow / Pink / White
2. Brilliance	Level1 / Level2 / Level3 / Level4
14. Guard Zone	
1. Color	White / Green / Orange / Black / Red
2. Brilliance	Level1 / Level2 / Level3 / Level4
3. Dusk	Same as "Day"
4. Night	Same as "Day"
5. Numeric Display	
1. Numeric Display (0)	Off Own Heading/Speed Own AXG Course/Speed Own Latitude/Longitude ROT/Rudder Depth/Temperature Relative Wide True Wind(Head) Waypoint Bearing/Distance Waypoint Latitude/Longitude Waypoint Arrival Time Cursor Bearing/Distance Cursor Latitude/Longitude Cursor Arrival Time MOB Bearing/Distance MOB Latitude/Longitude MOB Arrival Time EBL1/VRM1 EBL2/VRM2 Parallel Cursor TT Bearing/Distance TT CRS/SPD TT CPA/TCPA AIS Bearing/Distance AIS COG/SOG AIS CPA/TCPA Rate of Turn Rudder Depth Temperature
2. Numeric Display (1)	Same as "Numeric Display (0)"
3. Numeric Display (2)	Same as "Numeric Display (0)"
4. Numeric Display (3)	Same as "Numeric Display (0)"
5. Numeric Display (4)	Same as "Numeric Display (0)"
6. Numeric Display (5)	Same as "Numeric Display (0)"
7. Numeric Display (6)	Same as "Numeric Display (0)"
8. Numeric Display (7)	Same as "Numeric Display (0)"
9. Numeric Display (8)	Same as "Numeric Display (0)"
10. Numeric Display (9)	Same as "Numeric Display (0)"
11. Numeric Display (10)	Same as "Numeric Display (0)"
12. Numeric Display (11)	Same as "Numeric Display (0)"
13. Numeric Display (12)	Same as "Numeric Display (0)"
14. Tune Gauge	Off / On
15. Pulse Width	Off / On
16. Trails	Off / On
17. Alarm Area1	Off / On
18. Alarm Area2	Off / On

Item	Setting Contents
19. IR	Off / On
20. Target Enhance	Off / On
21. Gain/Sea/Rain	Off / On
22. Own Ship Trails	Off / On
23. Vector Length	Off / On
24. Function	Off / On
25. Process	Off / On
26. Zoom	Off / On
27. System Status	Off / On
28. Bearing Marker	Off / Scale / Scale/Numeric
29. Wind direction/Speed	Off / On
30. Wind mode	Ture / Relative
6. Wide Screen	Standard / Wide
7. Time	None / UTC / LT
14. RADAR Echo Color	
1. Yellow	Yellow1 / Yellow2 / Yellow3
2. Green	Green1 / Green2 / Green3
3. Orange	Orange1 / Orange2 / Orange3
4. Color	Color1 / Color2 / Color3
5. Custom	Custom1 / Custom2 / Custom3
6. Adjust Echo Color	Pattern1 / Pattern2 / Pattern3
15. Error Alarm Mask	
1. Scanner	
1. Scanner(Time Out)	
1. Alarm Detection	Off / On
2. Detection Time	0 - 999sec
2. Scanner(Data)	
1. Alarm Detection	Off / On
2. Detection Time	0 - 999sec
3. Scanner(Safety Switch)	
1. Alarm Detection	Off / On
2. Detection Time	0 - 999sec
4. Scanner(AZI)	
1. Alarm Detection	Off / On
2. Detection Time	0 - 999sec
5. Scanner(HL)	
1. Alarm Detection	Off / On
2. Detection Time	0 - 999sec
6. Scanner(MHV)	
1. Alarm Detection	Off / On
2. Detection Time	0 - 999sec
7. Scanner(Heater)	
1. Alarm Detection	Off / On
2. Detection Time	0 - 999sec
8. Scanner(Reverse)	
1. Alarm Detection	Off / On
2. Detection Time	0 - 999sec
9. Scanner(Video)	
1. Alarm Detection	Off / On
2. Detection Time	0 - 999sec
10. Scanner(Trigger)	
1. Alarm Detection	Off / On
2. Detection Time	0 - 999sec
11. Scanner(Fan 1)	
1. Alarm Detection	Off / On

Item	Setting Contents
2. Detection Time	0 – 999sec
12. Scanner(Fan 2)	
1. Alarm Detection	Off / On
2. Detection Time	0 – 999sec
13. Scanner(Motor)	
1. Alarm Detection	Off / On
2. Detection Time	0 – 999sec
2. Display Unit	
1. Display Unit(Video)	
1. Alarm Detection	Off / On
2. Detection Time	0 – 999sec
2. Display Unit(Trigger)	
1. Alarm Detection	Off / On
2. Detection Time	0 – 999sec
3. Display Unit(AZI)	
1. Alarm Detection	Off / On
2. Detection Time	0 – 999sec
4. Display Unit(HL)	
1. Alarm Detection	Off / On
2. Detection Time	0 – 999sec
5. Display Unit(DSP)	
1. Alarm Detection	Off / On
2. Detection Time	0 – 999sec
3. Connection Device	
1. Panel1(Time out)	
1. Alarm Detection	Off / On
2. Detection Time	0 – 999sec
2. GPS(Time Out)	
1. Alarm Detection	Off / On
2. Detection Time	0 – 999sec
4. RX Data	
1. GYRO/Compass	
1. Alarm Detection	Off / On
2. Detection Time	0 – 999sec
2. Log/2Log	
1. Alarm Detection	Off / On
2. Detection Time	0 – 999sec
3. Course/Speed	
1. Alarm Detection	Off / On
2. Detection Time	0 – 999sec
4. Depth	
1. Alarm Detection	Off / On
2. Detection Time	0 – 999sec
5. Temperature	
1. Alarm Detection	Off / On
2. Detection Time	0 – 999sec
6. Wind	
1. Alarm Detection	Off / On
2. Detection Time	0 – 999sec
7. Tide	
1. Alarm Detection	Off / On
2. Detection Time	0 – 999sec
8. Rate Of Turn	
1. Alarm Detection	Off / On
2. Detection Time	0 – 999sec

Item	Setting Contents
9. Rudder	
1. Alarm Detection	Off / On
2. Detection Time	0 - 999sec
10. Waypoint	
1. Alarm Detection	Off / On
2. Detection Time	0 - 999sec
11. Lat/Lon	
1. Alarm Detection	Off / On
2. Detection Time	0 - 999sec
12. Date	
1. Alarm Detection	Off / On
2. Detection Time	0 - 999sec
13. Datum	
1. Alarm Detection	Off / On
2. Detection Time	0 - 999sec
14. Status	
1. Alarm Detection	Off / On
2. Detection Time	0 - 999sec
15. HDOP	
1. Alarm Detection	Off / On
2. Detection Time	0 - 999sec
16. AIS	
1. Alarm Detection	Off / On
2. Detection Time	0 - 999sec
16. Test•System Information	
1. System Information	
2. System Time	
3. Scanner Information	
4. Hardware Information	
5. Error Log	
1. Display	
2. Erase	
6. Line Monitor	
7. Self Test	
1. Key Test	
2. Buzzer Test	
3. Key Light Test	
4. Monitor Display Test	
1. Pattern1	
2. Pattern2	
3. Pattern3	
4. Pattern4	
5. Pattern5	
6. Pattern6	
7. Pattern7	
8. Pattern8	
1.Red	0 - 255
2.Green	0 - 255
3.Bule	0 - 255
4.Display	
5. Memory Test	
6. Line Test	
7. Scanner Test	
17. Network	
1. Network Function	Off / On

Item	Setting Contents
2. IP Address	IP Address Input
3. RADAR echo transmission setting	
1. RADER echo transmission function	Off / On
2. Multicast IP	IP Input
3. Output Form	Quadrant / Octant / Sweep
4. Data Format	Normal / Compressed
18. NMEA2000	
1. NMEA2000 Out	Off / On
2. NMEA2000 PGN	
1. Water Speed (128259)	Off / On
2. Water depth (128267)	Off / On
3. XTE (129283)	Off / On
4. NAV. data (129284)	Off / On
5. NAV. Route/WP (129285)	Off / On
6. COG & SOG (129026)	Off / On
7. GNSS position (129029)	Off / On
8. Water temp (130310)	Off / On

**DECLARATION OF CONFORMITY****EU Declaration Of Conformity**

- 01) Apparatus Product/Model:**  
Product: Marine Radar.  
Model: JMA-3400 Series  
(JMA-3404/3406/3406HS/3411-4/3411-4HS/3411-6/3411-6HS)
- 02) Name & Address of the Manufacturer:**  
Japan Radio Co., Ltd.,  
21-11, Mure 6-chome, Mitaka-shi, Tokyo 181-0002 Japan.
- 03) This declaration of conformity is issued under the sole responsibility of the manufacturer.**
- 04) Object of the declaration – identification of apparatus allowing traceability:**
- Marine Radar, Japan Radio Co., Ltd manufactured model JMA-3404.
  - Marine Radar, Japan Radio Co., Ltd manufactured model JMA-3406.
  - Marine Radar, Japan Radio Co., Ltd manufactured model JMA-3406HS.
  - Marine Radar, Japan Radio Co., Ltd manufactured model JMA-3411-4.
  - Marine Radar, Japan Radio Co., Ltd manufactured model JMA-3411-4HS.
  - Marine Radar, Japan Radio Co., Ltd manufactured model JMA-3411-6.
  - Marine Radar, Japan Radio Co., Ltd manufactured model JMA-3411-6HS.
- 05) The object of the declaration described above is in conformity with the relevant EU harmonization legislation:**  
Radio Equipment Directive (RED): 2014/53/EU.
- 06) References to the relevant harmonized standards used, including the date of the standard, or references to other technical specifications, including the date of the specification, in relation to which conformity is declared:**
- ETSI EN 302 248 (v2.1.1) – Navigation radar for use on non-SOLAS vessels.  
IEC61162 series – as applicable.
- 07) Notified Body involved:**  
Not applicable.

08) Description of accessories and components, including software:  
System Components

		JMA-3404	JMA-3406	JMA-3406HS	JMA-3411-4	JMA-3411-4HS	JMA-3411-6	JMA-3411-6HS
Display Unit	NCD-2364	X	X	X	X	X	X	X
4kW Radome Scanner Unit	NKE-2043	X						
6kW Slot Antenna Scanner Unit	NKE-2063A		X					
6kW Slot Antenna Scanner Unit/ High speed craft	NKE-2063AHS			X				
10kW Slot Antenna Scanner Unit	NKE-2103-4				X			
10kW Slot Antenna Scanner Unit/ High speed craft	NKE-2103-4HS					X		
10kW Slot Antenna Scanner Unit	NKE-2103-6						X	
10kW Slot Antenna Scanner Unit/ High speed craft	NKE-2103-6HS							X

Software version:

Scanner Unit NKE-2043 V03.00

Scanner Unit NKE-2063A/2063AHS V03.00 / V03.11

Scanner Unit NKE-2103-4/4HS/6/6HS V02.11

Display Unit NCD-2364 V01.00

09) Additional Information:

Antenna length 2ft, Peak power 4kW(Magnetron) X-Band Scanner Unit:NKE-2043

Antenna length 3.9ft, Peak power 6kW(Magnetron) X-Band Scanner Unit:NKE-2063A

Antenna length 3.9ft, Peak power 6kW(Magnetron) X-Band Scanner Unit:NKE-2063AHS

Antenna length 4ft, Peak power 10kW(Magnetron) X-Band Scanner Unit:NKE-2103-4

Antenna length 4ft, Peak power 10kW(Magnetron) X-Band Scanner Unit:NKE-2103-4HS

Antenna length 6ft, Peak power 10kW(Magnetron) X-Band Scanner Unit:NKE-2103-6

Antenna length 6ft, Peak power 10kW(Magnetron) X-Band Scanner Unit:NKE-2103-6HS

12inch LCD Display Unit:NCD-2364

Signed for and on behalf of: Japan Radio Co., Ltd., Tokyo, Japan.

Place and date of issue:

Nagano-shi, Nagano, Japan Dated 7<sup>th</sup> December 2019

Navigation Group

Quality Assurance Department

Marine Systems

Name/function: Hiroshi Isohata / Manager

Signed: .....



Code: 7ZPRD0971





アスベストは使用しておりません  
Not use the asbestos

*For further information, contact:*

**JRC** *Japan Radio Co., Ltd.*

*Since 1915*

URL Head office : <http://www.jrc.co.jp/eng/>

Marine Service Department

1-7-32 Tatsumi, Koto-ku, Tokyo 135-0053, Japan

e-mail : [tmsc@jrc.co.jp](mailto:tmsc@jrc.co.jp)

One-call : +81-50-3786-9201

ISO 9001, ISO 14001 Certified

CODE No.7ZPRD1007

DEC. 2023 Edition 3